

I/28865/2023



भारत सरकार
Government of India
विद्युत मंत्रालय
Ministry of Power
उत्तर क्षेत्रीय विद्युत समिति
Northern Regional Power Committee

विषय: उत्तर क्षेत्रीय विद्युत समिति की प्रचालन समन्वय उप-समिति की 208^{वीं} बैठक का कार्यवृत्त
|

Subject: Minutes of the 208th OCC meeting of NRPC.

उत्तर क्षेत्रीय विद्युत समिति की प्रचालन समन्वय उप-समिति की 208^{वीं} बैठक दिनांक 20.06.2023 को आयोजित की गयी थी। उक्त बैठक का कार्यवृत्त उत्तर क्षेत्रीय विद्युत समिति की वेबसाइट <http://164.100.60.165> पर उपलब्ध है। यदि कार्यवृत्त पर कोई टिप्पणी हो तो कार्यवृत्त जारी करने के एक सप्ताह के अन्दर इस कार्यालय को भेजें |

The 208th meeting of the Operation Co-ordination Sub-Committee (OCC) of NRPC was held on 20.06.2023. The Minutes of this meeting has been uploaded on the NRPC website <http://164.100.60.165>. Any comments on the minutes may kindly be submitted within a week of issuance of the minutes.

संलग्नक: यथोपरि

(संतोष कुमार)
अधीक्षण अभियंता (प्रचालन)

सेवामें,

उ.क्षे.वि.स. के प्रचालन समन्वय उप-समिति के सभी सदस्य

उत्तर क्षेत्रीय विद्युत समिति की प्रचालन समन्वय उप-समिति की 208^{वीं} बैठक का कार्यवृत्त

The 208th meeting of OCC of NRPC was held on 20.06.2023 through video conferencing.

खण्ड-क:उ.क्षे.वि.स.

PART-A:NRPC

1. Confirmation of Minutes

Minutes of the 207th OCC meeting was issued on 14.06.2023.OCC confirmed the minutes.

2. Review of Grid operations of May 2023

Anticipated vis-à-vis Actual Power Supply Position (Provisional) for May 2023

Reasons submitted by States for significant deviation of actual demand from anticipated figures during the month of May 2023 are as under:

● **Himachal Pradesh**

The Anticipation in Energy Requirement as well as peak demand in respect of Himachal Pradesh for the month of May, 2023 came on the lower side due to unpredictable weather conditions in the State and rainfall at various periods of the month.

● **Punjab**

It is intimated that actual maximum demand is more as compared to anticipated maximum demand due to dry spell and rise in temperature in mid of month of May. Actual energy requirement is less as compared anticipated energy requirement because of rainfall in first and last week of May 2023 and comfortable weather during most of the month of May in the state of Punjab.

● **Rajasthan**

The Actual Energy requirement w.r.t. Anticipated Energy requirement for May' 2023 decreased by 11.5% and peak demand w.r.t. Anticipated peak demand for May' 2023 is increased by 10.5% due to unexpected variations in the weather (like spell of rains & Heat Wave) during the month of May 2023 in Rajasthan state.

● **Uttar Pradesh**

Due to unexpected rains and low atmospheric temperature in May 2023 in comparison to May 2022, energy requirement and energy Consumption was less than anticipated.

● **Uttarakhand**

I/28865/2023

The negative variation in actual Energy consumption w.r.t. anticipated Energy requirement due to unexpected rainfall, thunderstorm and snowfall in hilly areas in the month of May, 2023, causing drop in temperature compared to last year.

3. Maintenance Programme of Generating units and Transmission Lines

The maintenance programme of generating units and transmission lines for the month of July 2023 was deliberated in the meeting on 19.06.2023.

Following shutdown request was also approved/denied in the OCC meeting:

Element Name	Owner	Reason	Requested From	Requested To	Daily/Continuous	Decision of OCC
500 MW SINGRAULI STPS-UNIT 7	NTPC	Boiler License Renewal	25-Jul-23	29-Jul-23	Continuous	OCC approved the shutdown from 21 st July for 4 days as per mandatory requirement. NTPC was asked to ensure work is completed in minimum time.

4. Anticipated Power Supply Position in Northern Region for July 2023

The updated anticipated Power Supply Position for July 2023 is as below:

State / UT	Availability / Requirement	Revised Energy (MU)	Revised Peak (MW)	Date of revision
CHANDIGARH	Availability	190	350	No Revision submitted
	Requirement	210	430	

I/28865/2023

State / UT	Availability / Requirement	Revised Energy (MU)	Revised Peak (MW)	Date of revision
	Surplus / Shortfall	-20	-80	
	% Surplus / Shortfall	-9.5%	-18.6%	
DELHI	Availability	5320	8100	19-Jun-23
	Requirement	4050	8100	
	Surplus / Shortfall	1270	0	
	% Surplus / Shortfall	31.4%	0.0%	
HARYANA	Availability	5810	12555	19-Jun-23
	Requirement	6799	13457	
	Surplus / Shortfall	-989	-902	
	% Surplus / Shortfall	-14.5%	-6.7%	
HIMACHAL PRADESH	Availability	1151	1759	09-Jun-23
	Requirement	1115	1784	
	Surplus / Shortfall	36	-25	
	% Surplus / Shortfall	3.2%	-1.4%	
J&K and LADAKH	Availability	2320	3520	No Revision submitted
	Requirement	1570	2820	
	Surplus / Shortfall	750	700	
	% Surplus / Shortfall	47.8%	24.8%	
PUNJAB	Availability	8000	13978	19-Jun-23
	Requirement	8617	15000	
	Surplus / Shortfall	-617	-1022	
	% Surplus / Shortfall	-7.2%	-6.8%	
RAJASTHAN	Availability	9340	18330	19-Jun-23
	Requirement	7750	13200	
	Surplus / Shortfall	1590	5130	
	% Surplus / Shortfall	20.5%	38.9%	
UTTAR PRADESH	Availability	15810	26500	13-Jun-23
	Requirement	15655	27700	
	Surplus / Shortfall	155	-1200	
	% Surplus / Shortfall	1.0%	-4.3%	
UTTARAKHAND	Availability	1414	2398	13-Jun-23
	Requirement	1426	2450	

I/28865/2023

State / UT	Availability / Requirement	Revised Energy (MU)	Revised Peak (MW)	Date of revision
	Surplus / Shortfall	-12	-52	
	% Surplus / Shortfall	-0.8%	-2.1%	
NORTHERN REGION	Availability	49355	78900	
	Requirement	47192	76600	
	Surplus / Shortfall	2163	2300	
	% Surplus / Shortfall	4.6%	3.0%	

5. Follow-up of issues from various OCC Meetings - Status update

5.1. The updated status of agenda items is enclosed at **Annexure-A.I.**

5.2. In 208th OCC, SLDCs were requested again to coordinate with respective Transmission Utilities of states/UTs and submit details about the updated status of Down Stream network by State Utilities from ISTS Station (enclosed as **Annexure-A-I.I**) before every OCC meeting.

6. NR Islanding scheme

- 6.1. In the meeting (207th OCC), In the meeting (208th OCC), AEE(SS) apprised forum that draft report submitted by CPRI for Agra-Lalitpur Islanding scheme was deliberated in 206th OCC meeting and UPSLDC was asked to take up the issues discussed in the meeting with CPRI. In the 208th OCC meeting UPSLDC representative intimated forum that they have communicated the matter to STU vide letter dated 21.04.2023 for taking up with CPRI and comments from CPRI are awaited. MS, NRPC asked UPSLDC to kindly follow up with CPRI and expedite the matter.
- 6.2. Representative from UPPTCL apprised forum that with regard to Lucknow-Unchahar islanding scheme, the retendering for procurement of UFR's for the aforesaid islanding scheme has been done.
- 6.3. Representative from Rajasthan STU intimated forum that preparation of DPR is under finalization and would be shared shortly with NRPC Sectt. and NRLDC for Jodhpur-Barmer Rajwest and Suratgarh islanding scheme.
- 6.4. AEE(SS) apprised forum that Pathankot-RSD islanding scheme has been implemented in March end, however testing/commissioning reports with regard to islanding scheme is awaited. Punjab SLDC representative informed forum that testing/commissioning reports would be presented by STU in the upcoming protection sub-committee meeting of NRPC which is scheduled on 23.06.2023.

I/28865/2023

- 6.5. Further, with regard to Patiala-Nabha Power Rajpura islanding scheme representative from Punjab informed that tendering has not started and expected timeline for the aforesaid islanding scheme is December 2023.
- 6.6. With regard to Kullu-Manali islanding scheme representative from HPSLDC apprised forum that discom has intimated that approval is expected with one week from their management and upon approval the tentative timeline for implementation is around six months. Further, he intimated that Malana HEP has informed that the PFR testing work order has given to M/S Solvina pvt. Ltd. on dated 02.05.23, but they have not confirmed the Test date yet due to their busy schedule.
- 6.7. With regard to Shimla-Solan islanding scheme representative from HPSLDC apprised forum that they have done correspondence with BHEL regarding switching of Bhaba HEP to automatic mode during the situation of islanding formation but no response has been received from BHEL till date.
- 6.8. AEE(SS) apprised forum that a meeting has been scheduled on 22.06.2023 (at 3p.m.) with Delhi SLDC and DTL to deliberate on steady state analysis of PSSE basecase of Delhi islanding scheme.

7. Coal Supply Position of Thermal Plants in Northern Region

- 7.1. In the meeting, NRPC representative apprised the forum about the coal stock position of generating stations in northern region during current month (till 10th June 2023).
- 7.2. Average coal stock position of generating stations in northern region, having critical stock, during first ten days of June 2023 is as follows:

Station	Capacity (MW)	PLF % (prev. months)	Normative Stock Req'd. (Days)	Actual Stock (Days)
TALWANDI SABO TPP	1980	71.90	26	3.4

- 7.3. In the meeting, above mentioned generating station was requested to take adequate measures.

8. Review of Planned Outages for September, 2023 (Agenda by NRPC Sect.)

- 8.1. MS, NRPC informed forum that in the review meeting taken by Hon'ble Union Power Minister on 13.06.2023, it was directed that the planned outages for the month of September has to be reduced from 20.4GW to 11.4GW i.e. (9 GW has to be made available) to meet the anticipated shortages.
- 8.2. In the meeting, the list of outages of NR generating units falling in last week of August 2023 and month of September 2023 were reviewed in compliance of directions from Ministry.

I/28865/2023

- 8.3. RRVUNL vide mail dated 20.06.2023 (copy attached as **Annexure-II**), submitted the revised annual maintenance schedule of RRVUNL Power Stations for FY 2023-24 which was discussed in 208th OCC meeting. Based on the discussions held in the meeting, annual outage schedule for following units were tentatively revised:

Station	Unit	Capacity (MW)	Revised Outage from	Revised Outage To	Remarks
SSTPS SURATGARH	6	250	07-Jul-23	27-Jul-23	Annual Boiler Overhaul
SSTPS SURATGARH	5	250	01-Aug-23	21-Aug-23	Annual Boiler Overhaul
SSCTPS SURATGARH	8	660	25-Sep-23	15-Oct-23	Annual Boiler Overhaul
SSCTPS SURATGARH)	7	660	16-Nov-23	15-Dec-23	Annual Boiler Overhaul
KOTA TPS (KSTPS)	2	110	23-Jun-23	17-Jul-23	Annual Boiler Overhaul
KOTA TPS (KSTPS)	4	210	27-Jul-23	14-Aug-23	Annual Boiler Overhaul
KOTA TPS (KSTPS)	7	195	01-Oct-23	21-Oct-23	Annual Boiler Overhaul
KOTA TPS (KSTPS)	3	210	01-Jan-24	21-Jan-24	Annual Boiler Overhaul
KOTA TPS (KSTPS)	6	195	01-Feb-24	21-Feb-24	Annual Boiler Overhaul
KALISINDH TPS (KATPP)	1	600	01-Jul-23	21-Jul-23	Annual Boiler Overhaul
KALISINDH TPS (KATPP)	2	600	25-Jul-23	14-Aug-23	Annual Boiler Overhaul
CTPP CHHABRA	4	250	01-Oct-23	09-Nov-23	Capital Overhaul
CSCTPP CHHABRA	6	660	26-Jun-23	20-Jul-23	Annual Boiler Overhaul
CSCTPP CHHABRA	5	660	25-Jul-23	18-Aug-23	Annual Boiler Overhaul
RAMGARH CCPP	GT-1	35.5	01-Jan-24	30-Jan-24	Replacement of Diffuser and Exhaust Planuum
RAMGARH CCPP	GT-3	110	01-Feb-24	16-Mar-23	Major Inspection and Annual Maintenance
RAMGARH CCPP	ST-2	50	01-Feb-24	16-Mar-23	Annual Maintenance

- 8.4. With regard to SSTPS SURATGARH (Unit 3 – 250 MW) and CTPP CHHABRA (Unit 2 – 250 MW), RRVUNL intimated that these units were originally approved in LGBR 2023-24, but now they do not require the shutdown of these units. Hence, approval of original outage schedule of these units in the month of September 2023 stands cancelled.
- 8.5. APL representative informed forum that due to problem in high pressure control valve of Turbine in Unit-1, which is to be addressed on priority considering the

I/28865/2023

safety aspects they plan to prepone the overhaul of Unit 1 of KAWAI TPS from 01st Jul 23 to 25th Jul 23. OCC forum agreed to the request of Adani Power.

- 8.6. Owing to high anticipated demand in the month of September, OCC forum decided to defer the planned shutdown of Tanda TPS Unit 1 (110 MW) and Auraiya CCPP ST-2 (109.3 MW) to the month of October. Further, OCC forum asked NTPC to prepone the shutdown of Anta CCPP ST (153 MW) by one week.
- 8.7. Representative Haryana intimated forum that due to high anticipated demand they have deferred the shutdown of Rajiv Gandhi TPS Unit 2 (600 MW) till 15th Nov 2023.

9. Non Redundant connectivity between Aulsteng (JKPTCL) and Drass (Agenda by UT of Ladakh)

- 9.1. In regard to cited matter, CTU representative intimated that a meeting was held in CEA under the chairmanship of Member (Power Systems) for deliberation on the issue related to the reliability of power supply for UT of Ladakh on 06.06.2023. (copy of MoM is attached as **Annexure-III**).
- 9.2. He intimated forum that as an interim solution in the above meeting, POWERGRID informed that they are laying cable between Minamarg and Zojila Top section (15 km) of Alusteng – Drass 220 kV section of SLTS line to provide the strengthening in the most vulnerable section of SLTS. Further, these works would be completed by next season (October, 2024) and it would take care of the concerns of Ladakh PDD, about the vulnerability of SLTS line passing through avalanche prone zone, to some extent.
- 9.3. Further he apprised forum that as a long term solution, 220 kV interconnection from Pang RE Park to Leh/Phyang has already been agreed and after completion of which, Ladakh would have two independent interconnections from the National Grid.
- 9.4. CTU highlighted that in the CEA meeting dated 06.06.2023, it was also suggested that Ladakh may explore the possibility of implementation of small scale distributed RE projects with BESS, that would cater the local demand in Ladakh region techno-economically.
- 9.5. MS, NRPC stated that as the matter has been deliberated in the CTU meeting with CEA, and based on the feedback received from CTU the matter may not be regularly discussed in the OCC meetings.

10. Power evacuation problem of Power Stations of RVUNL (Agenda by RVUN)

- 10.1. With regard to the Power evacuation problem of STPS, Suratgarh, RRVUNL representative intimated forum that they are two dedicated 400 kV lines (Bikaner - STPS-SC) for evacuating power from both units of STPS-SC. Additionally, there are two interconnectors connecting STPS(6x250MW) and

I/28865/2023

STPS-SC(2x660MW). Currently, during the daytime, due to solar generation in Bikaner, these Bikaner lines are exporting

- 10.2. power to STPS instead of importing. Consequently, all the power generated by both STPC-SC units and the exported power from Bikaner is transmitted through the two interconnectors and ultimately evacuated through the outgoing feeders of STPS lines. This puts excessive stress on the old existing outgoing feeders of STPS, resulting in jumper/isolator failures in various lines. As a consequence, the units are frequently desynchronized to address these faults, leading to significant losses of DC to RVUN.
- 10.3. On the above matter, RVPN representative mentioned that till the commissioning of Bikaner-II sub-station an interim arrangement has been done from 765kV Bikaner(PG) to 400kV Bikaner(RVPN), wherein both circuits are connected to 400kV Bikaner (RVPN). During peak solar period approx. 1500 MW to 2000 MW RE power is coming to 400kV Bikaner(RVPN) from 765kV Bikaner (PG) and there is about 400MW of state RE injection at 400kV Bikaner(RVPN), some of this RE power is evacuated towards STPS Suratgarh. With the commissioning of Bikaner-II sub-station which is anticipated shortly there will be reduction in RE power coming at 400kV Bikaner (RVPN) which would provide some relief. Further, lines from STPS Suratgarh to Babai is expected by Dec'23 and 400 kV GSS at Hanumangarh is also planned, these additional elements would provide support in RE power evacuation in Bikaner complex.
- 10.4. Powergrid highlighted that the commissioning of STATCOM at Bhadla-II is almost complete and with this voltage profile will also improve at Bikaner RE pooling station as 400kV Bhadla (RVPN) and 400kV Bikaner (RVPN) are interconnected by double-circuit. Further, he also mentioned that STATCOM for Bikaner-II is expected to be commissioned in near future.
- 10.5. With regard to the Power evacuation problem of KTPS, Kota, RRVUNL representative intimated forum that the 220 kV feeders of PGCIL #1 & #2 are designated for importing generation from Unit # 6 & 7 of KTPS. However, at present, these feeders are predominantly exporting power rather than importing from KTPS. Additionally, other outgoing feeders such as Vatika, Heerapura, and Bewar have low load, causing the majority of KTPS generation to be exported through the Sakatpura feeders. The Sakatpura feeders are short-distance feeders, spanning approximately 500 meters, and the busbar protection at Sakatpura has been non-functional for an extended period. Consequently, all faults occurring at Sakatpura reflect back to KTPS, leading to adverse effects on its generation capacity.
- 10.6. On the above matter, RVPN representative mentioned that timeline for anticipated commissioning of 400kV GSS Sangod is around 24 months from sale purchase agreement which is likely to be completed in one or two month. With the commissioning of 400kV GSS Sangod, Bara will be directed

I/28865/2023

connected to it and load from Bara and Dahra centers will be diverted from KTPS to 400KV GSS Sangod. Also, 132 kV network presently being catered from KTPS will be diverted to 400KV GSS Sangod which will also provide some load relief.

- 10.7. Further, as an immediate solution to meet load at Sakatpura, RVPN is planning LILO of Kota(PG) to Duni line so that there is direct source from Kota(PG) to Sakatpura and some load at KTPS switchyard will be diverted. Presently this proposal is being studied by RVPN. RVPN also mentioned that with regard to non-functional busbar protection at Sakatpura, the A&FS is under approval and work is likely to be completed by Dec'23.
- 10.8. With regard to the Power evacuation problem of CTPP, Chhabra, RRVUNL representative intimated forum that there are two inter-connectors from CSCTPP, Chhabra to CTPP, Chhabra. Due to these two interconnectors almost 2/3 load of CSCTPP evacuate through CTPP out going feeders while two dedicated feeders from CSCTPP evacuates only 1/3 of the generated load. Moreover, 400kV CTPP-ADANI Line also injects load to the tune of 300-400 MW to CTPP Switchyard. All this extra load creates stress on Jumpers, Connectors, Isolators, formation of Hot Spots etc. at 400 kV Switchyard of CTPP.
- 10.9. On the above matter, RVPN representative mentioned that in the 3rd meeting of Northern Regional Standing Committee on Transmission it was decided that interconnection line between CSCTPP and CTPP has been made to cater to the contingency conditions and would remain open in normal condition. Presently due to operational point of view, this interconnector is being kept close to ensure the reliability of CSCTPP Chhabra.
- 10.10. RVPN mentioned that as decided in the 3rd NRSCTP meeting if interconnector is kept open then there will be some relief at switchyard of CTPP Chhabra. Further, with the commissioning of 400kV GSS Sangod, 220kV Aklera will be connected to Sangod which in turn will be connected to Anta and Kalisindh that will also provide some relief as some load will be diverted from CSCTPP, Chhabra.
- 11. Allotment of 500 MVA, 400/220 kV ICT available as regional spare at PGCIL's 400kV GSS Jaipur (South) to RVPN for utilization at RVPN's 400 kV GSS Chittorgarh. (Agenda by RVPN)**
- 11.1 In the meeting, RVPN representative informed forum that as an alternative they have planned one 315 MVA, 400/220 ICT which is expected by mid of July, and if they are able to get it by mid of July then they will be able to commission it before Rabi season.
- 11.2 He requested forum that in case, if this 315 MVA ICT is not received by mid of July then RVPN may be allotted the 500 MVA, 400/220 kV ICT available as

I/28865/2023

regional spare at PGCIL's 400kV GSS Jaipur (South) for utilization at RVPN's 400 kV GSS Chittorgarh.

- 11.3 Further, he mentioned that in the meanwhile bay work is under tendering stage and it is likely to be completed by September 2023.
- 11.4 Powergrid NR-1 intimated forum that they will get it examined whether the regional spare available at PGCIL's 400kV GSS Jaipur (South) has been identified for any utility.
- 11.5 Meanwhile MS, NRPC asked RVPN to kindly follow up with the concerned entity that 315 MVA ICT is received by mid of July so that regional spare may not be required.

12. Full schedule of units, for FGD PG test (Agenda by NTPC)

- 12.1. In the meeting, NTPC apprised forum that that it is implementing Flue Gas Desulphurization (FGD) systems in its thermal stations to meet SO2 emission norms and full load operation of the units for 5 days is required for PG test of FGD.
- 12.2. NRLDC mentioned that requisition is to be given by beneficiary.
- 12.3. OCC forum was of opinion that NTPC shall approach the concerned beneficiaries for their consent ten days before the PG test.

Decision of the OCC forum

- *Forum asked NTPC to approach the concerned beneficiaries for their consent ten days before the PG test.*

13. Revision of SPS scheme for safe evacuation of power from Anpara Complex (Agenda by UPSLDC)

- 13.1. In the meeting, UPSLDC representative intimated that following the LILO of 765kV Anpara D-Unnao line at Obra C TPS and in view of synchronization of 1x660 MW Unit at Obra-C TPS expected in July 2023, existing system protection scheme for safe evacuation of power from Anpara Complex, needs to be revised.
- 13.2. UPSLDC representative presented to the forum the proposed revised SPS scheme for Anpara Complex for both single and multiple contingencies. (Details of the scheme are attached as Annexure A.VII of the agenda).
- 13.3. Further, UPSLDC mentioned that they would require complete communication path b/w the stakeholder sub-stations viz. Unnao, Anpara C, Anpara D and Obra C. Presently, the optical fibre path from Unnao to Anpara D via Obra C is not through.
- 13.4. NRLDC asked UPSLDC to share the basecase with them and upon examination of same they would communicate its observation to UPSLDC.

I/28865/2023

Decision of the OCC forum

- Forum asked UPSLDC to submit the basecase for the proposed SPS with NRLDC for its examination.

14. Table Agenda No.1: Regarding Request for approval of Shutdown of 400kV Kankroli Jodhpur S/C Transmission Line for reconductoring with Twin HTLS Conductor (Agenda by Powergrid NR-1)

- 14.1. In the meeting, Powergrid NR-1 representative informed that reconductoring work of 400kV Kankroli Jodhpur S/C Transmission Line was approved in 9th meeting of NCT. The length of 400kV Kankroli Jodhpur line is 188 km and schedule of said work is 14 months. In which retrofitting of switchyard equipment will also take place both the end bays of transmission line.
- 14.2. Further, he mentioned that Powergrid has planned the de-conductoring and reconductoring work of the said line within 4 months.
- 14.3. NRLDC representative presented to the forum the past one-year line flow of 400kV Kankroli Jodhpur S/C Transmission Line and stated that before October line loading is comparatively high due to evacuation of wind generation of nearby complex through this line.
- 14.4. Rajasthan SLDC mentioned that from October onwards wind generation is not there or very minimal, hence said work may be planned after the month of September.
- 14.5. Considering the above, OCC forum viewed that reconductoring work of 400kV Kankroli Jodhpur S/C Transmission Line may be planned after the month of September when wind generation is not there.

Decisions of the OCC Forum

- Forum asked Powergrid that reconductoring work of 400kV Kankroli Jodhpur S/C Transmission Line may be planned after the month of September.

15. Table Agenda No.2: Regarding Removal of LILO of 400KV DC Bikaner(RRVPN)-Bhadla(RRVPN) Line from Bikaner (PG) and Extension of above LILO section from Bikaner (PG) to Bikaner-II further named as 400KV D/C Quad Bikaner(PG)-Bikaner-II line (Agenda by Powergrid NR-1)

- 15.1 G In the meeting, Powergrid NR-1 representative informed forum that pre-commissioning activities of 765/400kV Bikaner-II substation are almost complete. For commissioning of 765/400kV Bikaner-II substation, shutdown of both circuits of 400kV D/C Bikaner (PG)- Bikaner (RVPNL) is required by Powergrid. He also intimated that CEA clearance for charging of Bikaner-II substation is expected in one day and thereafter they will be able to energize 400kV Bikaner-II(PG)-Khetri Q/C line.

I/28865/2023

- 15.2** On the cited matter, NRLDC representative presented to the forum simulation study conducted by them for different scenario/cases in respect of shutdown of 400kV Bikaner(PG)-Bikaner(RS) D/C for commissioning of Bikaner_2 SS (detailed study result are attached as **Annexure-A.IV**).
- 15.3** Major observation of the study presented by NRLDC were as follows:
- To facilitate the SD of 400kV Bikaner(PG)-Bikaner (RS) D/C without ERS option, a total STOA curtailment of 1423-1723 MW would be required.
 - STOA curtailment of 200-300 MW would be required if quad moose ERS on 400kV Bikaner-Bikaner_2 becomes operational.
 - Simultaneous operation of ERS and 400kV Bikaner(PG)-Bikaner(RS)-1 is not desirable as the loading of later would increase beyond the permissible line loading limit of 1450 MVA.
 - With final commissioning of 400kV Bikaner-Bikaner_2 D/C, STOA curtailment of 100-200 MW at Fatehgarh_1 would be required for keeping the RE pocket n-1 compliant.
 - With revival of 400kV Rajasthan lines in gradual manner as indicated above, generation restriction of Rajasthan Solar and STOA curtailment would be removed.
 - It may be noted that incase of revival of 400kV Bhadla(RS)-Bikaner(RS) D/C, no curtailment of Rajasthan Solar or ISGS RE would be there after commissioning of 400kV Bikaner-Bikaner_2 DC.
- 15.4** In the meeting, NRLDC representative highlighted that in case of tripping of 765kV Bikaner-Khetri-1/2, loading on 400kV Bikaner-Bikaner_2 (ERS) would go beyond its thermal rating. SPS needs to be implemented in case loading of 400kV Bikaner-Bikaner_2 (ERS) crosses 1750 MVA.
- 15.5** RVPN representative informed that they would revive one circuit of 400kV Bhadla(RS)-Bikaner(RS) on ERS by 30th June 2023.
- 15.6** Considering the proposal of RVPN to revive 400kV Bhadla(RS)-Bikaner(RS)-1 on ERS, OCC forum asked NRLDC to do a simulation study to check if any RE curtailment would be there in this case.
- 15.7** Further, with regard to SPS that needs to be implemented in case loading of 400kV Bikaner-Bikaner_2 (ERS) crosses 1750 MVA, OCC forum asked NRLDC to submit to Powergrid the SPS logic that needs to be implemented.

Decision of the OCC forum

- *Forum asked NRLDC to do a simulation study considering the proposal of RVPN to revive 400kV Bhadla(RS)-Bikaner(RS)-1 on ERS to check if any RE curtailment would be there in this case.*

I/28865/2023

- Forum also asked NRLDC to submit to Powergrid the SPS logic that needs to be implemented in case loading of 400kV Bikaner-Bikaner_2 (ERS) crosses 1750 MVA.

खण्ड-ख: उ.क्षे.भा.प्रे.के.

Part-B: NRLDC

16. NR Grid Highlights for May 2023

NRLDC representative highlighted the major grid highlights of May 2023:

- Maximum energy consumption of Northern Region was **1555 MUs** on 23rd May'23 and it was 0.9 % higher than May' 2022 (1540 MUs 20th May'22)
- Average energy consumption per day of Northern Region was **1258 MUs** and it was 8.9 % lower than May'22 (1381Mus per day)
- Maximum Demand met of Northern Region was **72625 MW** on 23rd May'23 @14:00 hours (based on data submitted by Constituents) as compared to 68398 MW on 13th May'22 @23:00 hours.

No all-time high value recorded in May'23:

Comparison of Average Energy Consumption (MUs/Day) of NR States for the May'22 vs May'23

State/ UT	May- 2022	May- 2023	% Diff
Chandigarh	5.9	5.0	-16.3%
Delhi	120.6	100.7	-16.5%
Himachal Pradesh	32.4	29.2	-9.7%
Haryana	182.0	164.4	-9.6%
Jammu & Kashmir	48.0	55.1	14.9%
Punjab	204.2	170.3	-16.6%
Rajasthan	288.8	264.8	-8.3%
Uttarakhand	44.9	43.3	-3.7%
Uttar Pradesh	454.3	425.4	-6.4%
Northern region	1381.1	1258.2	-8.9%

Frequency Data

Month	Avg. Freq. (Hz)	Max. Freq. (Hz)	Min. Freq. (Hz)	<49.90 (% time)	49.90 - 50.05 (% time)	>50.05 (% time)

I/28865/2023

May'23	50.03	50.43 on 18.05.23 01:19:40 hrs	at 15.05.23 11:52:00 hrs	on 19.8	68.5	21.7
May'22	50.00	50.35 on 23.05.22 09:07:20 hrs	at 03.05.22 14:55:00 hrs	at 9.9	72.2	17.9

Detailed presentation on grid highlights of May'2023 as shared by NRLDC in OCC meeting is attached as Annexure-B.I.

17. Grid Operation related issues

a) Tower collapse in six no.s line in RVPN control area

NRLDC representative stated that as discussed recently in 66th NRPC meeting, towers of following lines have collapsed in Western Rajasthan (Renewable Energy area):

- I. 400 KV Bhadla(RVPN)-Bikaner(RVPN) Ckt-1 (out since 15.05.2023)
- II. 400 KV Bhadla(RVPN)-Bikaner(RVPN) Ckt-2 (out since 15.05.2023)
- III. 400 KV Bhadla(RVPN)-Merta (out since 25.05.2023, revived on 13.06.2023)
- IV. 400 KV Bhadla(RVPN)-Jodhpur (out since 25.05.2023)
- V. 400 KV Jaisalmer-Barmer Ckt-1 (out since 30.05.2023)
- VI. 400 KV Jaisalmer-Barmer Ckt-2 (out since 30.05.2023)

Lines at s.no. I & II were antitheft charged from Bhadla (RVPN) end and provided voltage support during high RE generation. Lines at s.no. III & IV are for evacuating solar generation from Bhadla(RVPN) whereas lines at s.no. V & VI are for evacuating wind generation from Akal/Jaisalmer area.

Forced outage of all these six lines is leading to constraints in renewable generation evacuation in Rajasthan control area during high solar and high wind generation and there is need for RE curtailment in such scenarios (likely curtailment of renewable generation to the tune of 1500-2000MW).

It is extremely important that for safe evacuation of renewable generation, these lines are revived at the earliest. Moreover, as discussed in meeting held on 01.06.2023 between NRPC, NRLDC, CTUIL and RVPN, commissioning of 400kV Bikaner-II S/s is required for allowing further RE generation evacuation from ISTS RE complex. For commissioning works of 400kV Bikaner-II S/s, shutdown of 400kV Bikaner(PG)-Bikaner(RVPN) both ckts. would be required.

For ensuring reliable evacuation of the renewable generation along with safe and secure operation of the grid, it is desirable that the transmission system is intact and in service. Recently it has been observed that a number of multiple tripping including tower damages are happening during inclement weather condition.

I/28865/2023

There has been frequent tripping of transmission lines that happened in the month of May & June 2023 in the Rajasthan RE pocket during inclement weather conditions. These transmission lines are important and critical for safe evacuation of power from RE plants and simultaneously frequent tripping of these lines can lead to threat to system security and grid stability.

RVPN representative stated that 400kV Bhadla(RVPN)-Bikaner(RVPN) ckt 1 & 2 are expected to be charged by July'23 end. One ckt is expected to be revived shortly on ERS. 400kV Bhadla-Jodhpur is expected to be revived by 20th July 2023. 400kV Jaisalmer- Barmer ckt1 & 2 are expected to be revived by July'23 end.

NRLDC representative stated that since high wind season is going on in Rajasthan, therefore RVPN may expedite revival of transmission lines on priority.

POWERGRID NR-1 representative stated that they are also examining reasons for tower failures in Rajasthan geographical area. Earlier, there used to be tower collapse in NCR area but now may be due to change in wind zone more towers are collapsing in Rajasthan area.

OCC forum discussed and agreed that given the frequent tripping of lines and outage due to tower collapse in RVPN control area during summer/monsoon season, a thorough study in respect of design of tower & maintenance of lines in this area is required from RVPN side. RVPN was asked to take proactive measures to minimize such tripping in future during inclement weather conditions.

b) Issues due to Double Bus Scheme at 220 kV level of RE Pooling Stations

As per Central Electricity Authority (Technical Standards for Construction of Electrical Plants and Electric Lines) Regulations, 2022, the bus switching schemes to be adopted at 220 kV voltage level are:

S. No.	Air Insulated Substation	Gas Insulated Substation
1.	Main and Transfer Bus Scheme	Main and Transfer Bus Scheme
2.	Double Bus Scheme	Double Bus Scheme
3.	Double Main and Transfer Bus Scheme	-

It has been observed that the most of the RE generation stations (developer end) are being developed with double bus scheme at 220 kV level. Further, some of the

I/28865/2023

GIS RE pooling stations (ISTS) are also being developed with double bus scheme at 220 kV level.

In the meeting, it was highlighted that in case of Double Bus Scheme, the maintenance of the circuit breaker of any feeder is not possible without taking the feeder out of service.

Double Bus Single Breaker Scheme

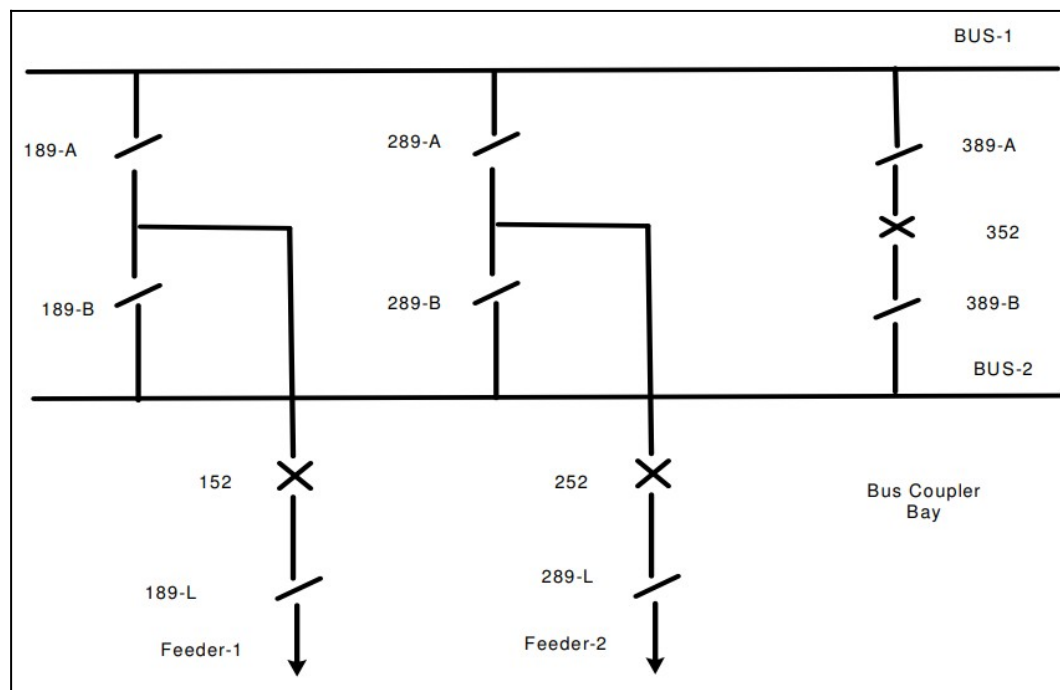

Maintenance of the CB

In case of RE plants, the evacuation from RE generation station to ISTS pooling station is generally planned through a 220 kV dedicated transmission line. The 'N-1' reliability criteria is exempted for this dedicated line. The implementation of double bus scheme in such scenario means that any damage to the dedicated line circuit breaker (at either end) and its subsequent maintenance would result in long outage of transmission line, thereby resulting in loss of significant RE generation also during that period.

Recently, on 28th May 2023, multiple elements in Rajasthan RE complex tripped due to inclement weather. The problem in circuit breaker of 220 kV TPREL – Bhadla (PG) line at Bhadla end was also identified in this event. As the GIS portion of 220 kV Bhadla PG has double bus scheme, the 220 kV TPREL – Bhadla (PG) line as well as TPREL generation is out of service since 28th May 2023 for maintenance of the aforementioned breaker.

I/28865/2023

The implementation of double main and transfer bus scheme would avoid such situations as the faulty circuit breaker can be isolated and taken up for maintenance without outage of the feeder. The feeder will remain in service through transfer bus coupler and associated feeder isolator.

Double Main and Transfer Bus Scheme

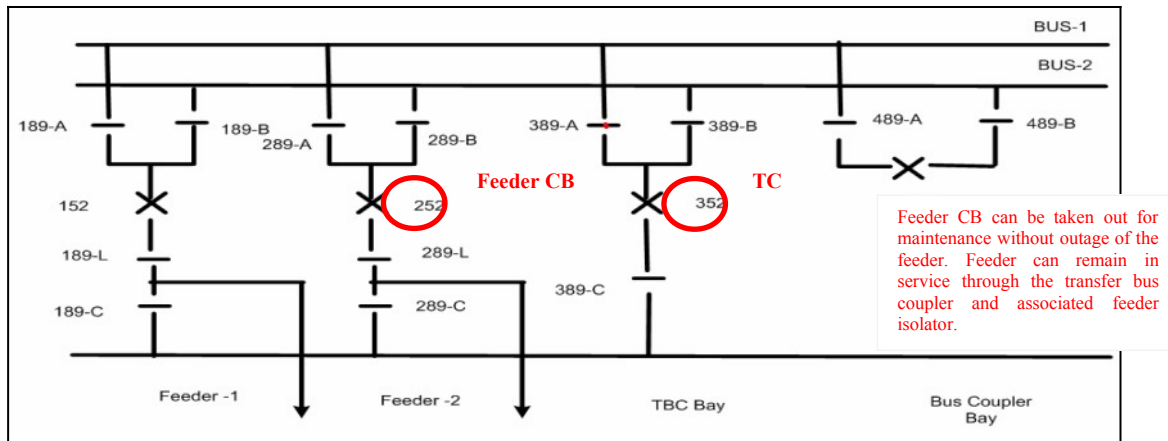

The implementation of double main and transfer bus scheme at RE generation stations (developer end) and RE pooling stations (ISTS) is of utmost important to avoid complete generation outage of a RE plant in case of damage to/maintenance of the dedicated line circuit breaker.

In this regard, following was discussed in the meeting:

- a) Double Main and Transfer Bus Scheme may be mandated for all ISTS RE Pooling Stations irrespective of station type (AIS/GIS). This aspect may be explicitly mentioned in RfP also for providing better clarity to prospective bidders in advance.
- b) RE developers may also explore the possibility of implementing Double Main and Transfer Bus Scheme in place of Double Bus Scheme at their respective 220 kV switchyards. At present, around 46 nos. of ISTS connected RE plants (out of total 51 nos.) in Rajasthan have Double Bus Scheme at 220 kV level.

POWERGRID representative stated that almost at all 220kV GIS substations there is double bus scheme. NRLDC representative stated that in case of single breaker outage, the RE generation loss may be higher than cost of developing double main and transfer scheme.

I/28865/2023

OCC forum agreed that the matter may be discussed separately between CTUIL, POWERGRID, NRPC, NRLDC and RE developers and then discussed again in OCC forum.

c) Uprating of low rating switchgear at 400kV Nawada, Dhanoda & Mahendragarh

The issues related to low ratings of switchgear at Nawada, Dhanoda & Mahendragarh have been discussed in various NRPC (Northern Region Power Committee), NRPCTP (Northern Region Power Committee on Transmission Planning) & NRSCT (Northern Region Standing Committee on Transmission) meetings. As per Transmission Planning Criteria, the thermal capacity of Quad Moose line is 2180 MVA at 45° ambient temperature. However, as the isolators at 400 kV Nawada, Dhanoda and Mohindergarh stations are rated at only 2 kA, the thermal capacity of respective lines gets limited to only 1385 MVA (1.732*400*2).

These limitations have already caused constraints in real-time operation on many occasions and accordingly the switchgear related issues were raised by NRLDC through written communication and in various meetings (NRPC, OCC, NRSCT, NRPCTP). Due to switchgear related issues, bypass of 400kV Mahendragarh-Dhanoda D/C and 400kV Dhanoda-Neemrana D/C at 400kV Dhanoda has been done; operating these lines as 400kV Mahendragarh-Neemrana D/C.

The issue has been discussed in number of meetings & HVPNL has agreed for switchgear replacement work in these meetings. However, as per information available with NRLDC, the switchgear replacement work are yet to be completed.

In the meeting, HVPN representative informed that the price bid have been opened for switchgear replacement at Nawada & Dhanoda.

OCC forum discussed that for bays at Mahendragarh, switchgear replacement work may be carried out by ATIL (Adani Transmission) and asked HVPN to expedite switchgear upgradation work at Nawada & Dhanoda.

d) Issues in declaration of AVC by RE Plants

NRLDC representative stated that it has been observed that some RE plants such as (300MW Azure Mapple, 300 MW Acme Heergarh, RSRPL connected at Bikaner (PG), 130 MW Azure Power 34 at Bhadla (PG) and 200 MW Azure at Adani Bhadla and 300 MW Thar Surya 1 at Bikaner (PG)) are submitting full AvC (Available capacity) whereas the maximum generation is far less than the AvC/contract capacity/Installed Capacity and also Low CUF are being observed in these plants compared to other RE plants. Matter was already apprised in 204th OCC forum, CEA and Bidding agencies such as SECI, MSEDCL.

I/28865/2023

On enquiry, plants reported the following reasons over phone/through mail as below:

300MW Azure Mapple:

Approx.6000+ tracker we have projected to install in the plant out of which 30% of the tracker are in operational condition and for remaining tracker we are facing some technical issues to make it live, hence the structures are not inclined properly to harness the max power. We are in the continuous discussion with OEM to close the technical issues and supply of any accessories are required for making it operational of remaining trackers. Also faces the local challenges regarding the incidences of installed cables connected to the solar panels, as the reason not able to account more power especially during the peak hours. We are in the process of procurement of cables to maximize the generation.

300 MW Acme Heergarh

Our project capacity is 300 MW as mentioned in the commissioning certificate. However, our installed DC capacity is 333.19 MWp against originally planned 445 MW due to supply chain disruptions which is acknowledged by MNRE vide OM dated 25.01.2023. Additionally, there are fixed losses like temperature (8-12%), DC cable, conversion, soiling, mismatch, degradation, IAM, irradiance losses to the extent of 20 to 25% of total capacity. You may appreciate that this is completely beyond our reasonable control.

We would like to re-iterate that the cumulative capacity rating of solar inverters installed in our project is 300 MW AC and hence our AVC is 300 MW. We have attached the inverter wise capacity for your reference.

RSRPL connected at Bikaner (PG) (through RSPPL line)

With reference to trailing, we would like to inform you that, we have received the NOC of 300MW (150MW Phase-1 and 150MW Phase-2) on 6th April'23 and accordingly we started the generation of phase-2 (150MW) from 7th April'23. Our phase-2 plant is under stabilization since then and generally it takes 20 to 25 Days.

Further in addition to above we are submitting the forecasting as per the actual generation available from our plant.

So, we request you to kindly consider the stabilization period of the plant.

130 MW Azure Power 34 at Bhadla (PG) and 200 MW Azure at Adani Bhadla

As reported by site they are facing issues in ventilation fans of IGBTs in inverter, due to this inverters can generate only upto 70% only. Accordingly less generation is observed in these plants.

I/28865/2023

300 MW Thar Surya 1 at Bikaner (PG):

Thar Surya also reported cable theft issue, IGBT issue in inverters etc.

- CERC vide letter dt: 03.03.2017, has issued the approved “Procedure for implementation of the framework on Forecasting, Scheduling and Imbalance Handling for Renewable Energy (RE) Generating Stations including Power Parks based on wind and solar at Inter-State level.
- In the above regulation/procedure the definition of AvC is given which is as follows:

“Available Capacity (AvC)’ for wind or solar generators which are regional entities is the cumulative capacity rating of the wind turbines or solar inverters that are capable of generating power in a given time-block.”

- In the SOR of the above mentioned procedure commission quoted the following:

*“AvC would be equal to the Installed Capacity, **unless one or more turbines/inverters are under maintenance or shutdown**. Any attempt at misdeclaration, that is declaration of capacity when it is actually not available due to reasons of maintenance or shutdown etc **would be treated as gaming and would be liable to action under appropriate provisions of the Act or the Regulations**”.*

- In this regard the following clauses related to Gaming may be referred:

IEGC Clause-6.4.18:

*It shall be incumbent upon the ISGS to declare the plant capabilities faithfully, i.e. according to their best assessment. In case, it is suspected that they have deliberately over/under declared the plant capability contemplating to deviate from the schedules given on the basis of their capability declarations (and thus make money either as undue capacity charge or as the charge for deviations from schedule), **the RLDC may ask the ISGS to explain the situation with necessary backup data.***

IEGC Clause-6.4.24:

*RLDC shall periodically review the actual deviation from the despatch and net drawal schedules being issued, to check whether any of the regional entities are indulging in unfair gaming or collusion. **In case any such practice is detected, the matter shall be reported to the Member Secretary, RPC for further investigation/ action.***

I/28865/2023

ACME Heergarh and Thar Surya1 plants reduced AvC after matter was raised with these plants, but Azure plants are yet to revise their AvC.

SE(O) NRPC requested NRLDC to share data with NRPC Sectt. for analysis and further action from NRPC end. NRLDC has shared the data with NRPC. OCC forum noted the same.

e) Long outage of transmission elements

NRLDC representative requested utilities to expedite restoration of the Grid elements under long outage at the earliest and also provide an update regarding their expected restoration date/time in the meeting/ NRLDC outage portal.

Some of the key elements that need to be revived at the earliest:

- 400/220 kV 240 MVA ICT 2 at Orai(UP)
- 400/220 kV 315 MVA ICT 2 at Mundka(DV)
- 400/220 KV 240 MVA ICT 3 AT Moradabad (UP)
- 400KV Bus 1 at Vishnuprayag(JP)
- 400KV Bus 2 at Parbati_3(NH)
- 400KV Bus 2 at Noida Sec 148(UP)
- 220 KV Kishenpur (PG)-Mir Bazar (PDD) Ckt-1

DTL representative stated that ICT at Mundka is expected by 25th June 2023.

All utilities agreed to regularly update their expected restoration time in NRLDC outage portal and expedite restoration of grid elements under forced outage.

f) Update of Important grid element document in line with IEGC:

In line with section 5.2. (c) of IEGC, list of important grid elements in Northern region would be compiled by NRLDC shortly. Such elements shall be opened/closed only on instructions from NRLDC. NRLDC has requested utilities to submit the list of all elements with details charged under their jurisdiction from

I/28865/2023

1.4.2022 till date including those expected to be commissioned till May 2023 so that the same could be included in the list vide email dated 23rd March 2022.

In 206 & 207 OCC meeting, it was requested to provide details before 30th April 2023.

NRLDC representative stated that based on feedback received from utilities, the document has been updated and is available <https://nrlc.in/download/important-grid-element-of-northern-region-may-2023/?wpdmdl=12562>.

Any feedback related to inclusion/deletion of elements may also be provided at the earliest.

OCC forum noted the same.

g) Update of Operating Procedure document of Northern region:

In compliance with Regulation 5.1 (f) of Indian Electricity Grid Code, Operating Procedure document would be updated by NRLDC in mid-July 2023. Latest available document is available@ <https://nrlc.in/download/final-operating-procedure-for-northern-region-2022-23/?wpdmdl=10826>

It was requested in 206 OCC meeting to provide feedback regarding the operating procedure document. Utilities were once again requested to provide their inputs/comments for any suggested changes in the document. It was requested that inputs/comments may be provided by 25th June 2023.

Members agreed to provide their comments latest by 25th June 2023.

h) Handholding workshop on RE integration for SLDC Rajasthan

In an endeavour to better understand and smoothen the pre-charging activities (Registration & First time charging process) of upcoming RE generation at Intra-state, an online workshop was convened by NRLDC with the FTC coordinators of Rajasthan SLDC and Intra-state RE developers on 25.05.2023. Around 25 participants attended the workshop.

Requisite data for RE plants, simulation models & study reports, validation of simulation models to check compliance w.r.t CEA technical standards for connectivity to the Grid and Requirement (if any) of tuning of Inverters/WTG parameters & Plant controllers were discussed in the workshop. NRLDC also explained the FTC procedure of Grid-India.

Further, separate FTC workshop was conducted on 16th June 2023 for all other stakeholders.

OCC forum noted the same and appreciated the efforts of NRLDC.

18. TTC/ATC of state control areas for monsoon 2023

As discussed in previous OCC meetings, most of the NR states except J&K, Ladakh and Chandigarh U/Ts are sharing basecase and ATC/TTC assessment with

I/28865/2023

NRLDC. OCC has advised all states to timely declare TTC/ATC for prospective months and revise the figures as per requirement.

Latest state wise issues are listed below:

Haryana:

TTC: 9100MW

ATC: 8800MW

In 207 OCC meeting, Haryana representative stated that following works are expected by Jun'23:

- New 500MVA ICT at Kurukshetra(PG)
- Connection of one circuit of 220 KV Jhajji - Rai D/C line and 220 kV Rai - RGEC D/C line on terminal towers outside 220 KV GIS S/Stn. HSIIDC, Rai (U/C) to give relief at 400 KV S/Stn Deepalpur
- 220kV Sec 32 Panchkula and 220kV lines to Panchkula (PG) (expected by Jun 2023 end)
- 220kV lines from Panchkula(PG) to Pinjore (expected by Jun 2023 end)
- Matter regarding new ICT at Deepalpur is under discussion with Indigrid.

In 208 OCC meeting, Haryana SLDC representative informed:

- Revised ATC/TTC has been shared with NRLDC
- 220kV lines from Panchkula are expected by July end

NRLDC representative asked HVPN to expedite commissioning of new elements which would help to meet higher demand with minimal transmission related issues.

Punjab:

TTC: 9500MW

ATC: 9000MW

I/28865/2023

In 207 OCC meeting, Punjab representative stated that following works are expected shortly:

- 315MVA ICT to 500MVA ICT at Nakodar (second week of Jun)
- 400/220kV Dhanansu S/s (mid-July)

In 208 OCC meeting, Punjab SLDC representative informed:

- 315MVA ICT to 500MVA ICT at Nakodar is expected by 20 Jun'23
- 400/220kV Dhanansu S/s is expected by Aug 2023.

Punjab SLDC was asked to ensure that loading of 400/220kV ICTs is within their N-1 contingency limit during the paddy season.

Delhi:

TTC: 7100MW

ATC: 6800MW

NRLDC representative stated that non-availability of ICT at Mundka would create N-1 related issues at Mundka. Last year, even with three ICTs, N-1 non-compliance was observed and presently, only two ICTs are available. It was also mentioned that given the criticality, mock testing of already implemented SPS may be carried out at 400/220kV Mundka. DTL representative agreed for the same.

Delhi SLDC has shared ATC/TTC limits for summer/ monsoon 2023 on 12.06.2023. NRLDC has shared few queries on 13.06.2023 regarding assessment done by Delhi SLDC. Delhi SLDC informed that they have submitted reply on 16.06.2023.

DTL representative stated that Bawana SPS was discussed in last OCC meeting. NRLDC representative stated that SPS logic was found in order. DTL representative agreed to implement Bawana SPS scheme at the earliest.

DTL representative further requested that ICT capacity is to be augmented at Bawana. NRLDC representative stated that the matter may be conveyed to CEA PSPA division by DTL first for approval.

I/28865/2023

Rajasthan:

TTC: 7600MW

ATC: 7000MW

Raj SLDC was requested to share ATC/TTC limits for summer/ monsoon 2023 at the earliest. NRLDC has shared comments on limits and basecase submitted by RVPN

In 208 OCC meeting, RVPN representative informed that:

- Reply submitted to queries of PSDF for new capacitor installation, meeting is scheduled on 20.05.2023 with NRPC, NRLDC and PSDF, CEA regarding proposal for capacitor bank installation.
- Third party compliance check is pending. Certificate expected by 22 June 2023 after which PMU data sharing would be completed.

UP:

TTC: 15400MW

ATC: 14800MW

In 207 OCC meeting, UP representative stated that new ICT at 400/220kV Sohawal is expected shortly whereas at Gorakhpur (UP), ICT replacement is not expected in this summer. UP representative stated that mock testing has already been carried out at Nehtaur & Gorakhpur S/s and would also be carried out at other substations shortly.

UP SLDC was requested to share revised ATC/TTC limits for paddy 2023 at the earliest.

UP SLDC representative informed that:

- ***Major issue is being observed at Gorakhpur(UP), Sohawal(PG) and Allahabad(PG) during high demand season.***
- ***Load has been shifted to Jhusi to relieve loading of Allahabad(PG) and new ICT is expected at Sohawal(PG)***
- ***They shall share revised ATC/TTC limits at the earliest.***

I/28865/2023

HP:

HP SLDC & POWERGRID informed that CT ratio at Nallagarh end has been changed and line can now be loaded to higher power (more than 350MW) provided margin availability in 400/220kV ICTs at Nallagarh.

Uttarakhand:

Uttarakhand SLDC vide email dated 28.04.2023 submitted their ATC/TTC assessment for summer 2023. NRLDC vide email dated 02.05.2023 have shared their comments to the ATC/TTC assessment done by Uttarakhand.

Uttarakhand SLDC agreed to provide update and mock testing report of Kashipur SPS.

Uttarakhand SLDC representative informed that they are in agreement with ATC/TTC assessment shared by NRLDC and mock testing report of Kashipur SPS has also been shared today.

J&K

Loading of 400/220kV Amargarh ICTs was above N-1 contingency limits. 220kV Amargarh-Ziankote D/C lines are also N-1 non-compliant for most of the time during winter months.

Apart from above, there are issues related to huge MVAR drawl by J&K control area during winter season.

J&K representatives had intimated during 47th TCC and 49th NRPC meeting that they would be sharing ATC/TTC assessment with NRLDC from October 2021, however the same is still awaited.

NRLDC had taken online training sessions for J&K representative (two in Feb 2023, two in March 2023 and two in Apr 2023). J&K and Ladakh U/Ts are once again requested to advise the concerned officers to evaluate their ATC/TTC limits in coordination with NRLDC and share latest assessment with NRLDC and NRPC.

Punjab, Haryana, HP, Rajasthan, Uttarakhand, Delhi & UP are communicating with NRLDC regularly regarding ATC/TTC assessment for summer/monsoon 2023.

I/28865/2023

However, J&K are yet to provide their ATC/TTC assessments for summer/monsoon 2023.

Punjab, Haryana and UP have shared their ATC/TTC assessment considering number of transmission elements that were anticipated to be commissioned. Based on actually commissioned transmission elements, these states were requested to review and submit their ATC/TTC for summer/monsoon 2023.

At number of substations, loading of major 400/220kV ICTs were observed to be beyond their N-1 contingencies. Plots attached as Annexure-B.I of Agenda.

It is again requested that SLDCs may ensure that loading of ICTs and lines are below their N-1 contingency limits. While requisitioning power from various sources, states should take care to limit their scheduled drawl as well as actual drawl in real time within the Available Transfer Capability (ATC) limits assessed by SLDC and NRLDC. NRLDC is continuously sending emails in real-time for ensuring N-1 compliances as well as restricting schedule till ATC limit and maximizing internal generation. SLDCs need to ensure this during real-time operation.

As discussed in last several OCC meetings, all SLDCs need to furnish ATC/TTC details of their control area at respective SLDC websites. Now, it is being observed that most of the SLDCs except J&K are uploading ATC/TTC limits on their websites.

SLDC	Link for ATC on website
UP	https://www.upsldc.org/documents/20182/0/ttc_atc_24-11-16/4c79978e-35f2-4aef-8c0f-7f30d878dbde
Punjab	https://www.punjabslcdc.org/downloads/ATC-TTC0321.pdf
Haryana	https://hvpn.org.in/#/atcttc
Delhi	https://www.delhisldc.org/resources/atcttcreport.pdf
Rajasthan	https://sldc.rajasthan.gov.in/rrvpngl/scheduling/downloads
HP	https://hpsldc.com/mrm_category/ttc-atc-report/
Uttarakhand	https://uksldc.in/ttc-atc
J&K and Ladakh U/T	NA

It is seen that most of the links are old and have old ATC/TTC limits.

I/28865/2023

All SLDCs were requested to regularly update ATC/TTC limits after mutually agreement between SLDC and NRLDC.

OCC members agreed for the same.

19. Metering related agenda points

1) Requirement of standby meters on various element in BBMB control area feeders

NRLDC member stated the requirement of standby meters on various element in BBMB control area feeders. In such locations the only installed meter is considered as main meter for accounting purpose. The lack of standby meters for these elements poses a problem when it comes to validating and substituting data in case the installed meter becomes faulty. Therefore, ensuring the accuracy of meter data is essential for authentic and reliable accounting. Having standby meter data greatly aids in verifying and validating meter data. Additionally, in the event of one end meter failure, data from the other end's meter is used as a substitute if one end meter data is considered as main meter for accounting purpose. A comprehensive list of meters in BBMB control area feeder, on which only a single meter is currently installed and utilized for accounting purposes, is submitted in Annexure-B.II of Agenda. Hence, for authentic and reliable accounting, stand by meter can be installed on mentioned feeder as per list in Annexure-B.II of Agenda.

Powergrid member stated that CTUIL has to intimate Powergrid on the said matter since meter installation and procurement work is done by POWERGRID as per directions and confirmations from CTUIL. As member from CTUIL was not present in the meeting Powergrid will not be able to commit anything on the issue.

Member secretary NRPC directed that the agenda be taken in 67th NRPC Committee meeting.

2) Unavailability of software/OEM support for L&T (VINCOM software) and ELSTER (Pearl software) IEM meters.

NRLDC informed that currently, in the NR region, there are a total of 2,700 meters installed by Powergrid with make of Secure, L&T, and Elster along with associated software provided by mentioned 3 vendors. Out of these, approximately 590 meters are of ELSTER make using PEARL software, and 31 meters are of L&T make using Vincom software . Recently, several issues have arisen regarding the software

I/28865/2023

platforms when converting encrypted meter data files into a readable format i.e. (.npc format). The PEARL and VINCOM software gets stuck or becomes quite slow leading to conversion problem which causes delays in data processing which hampers other activities and may lead to delay in submission of processed data to NRPC for timely issuance of deviation account. Hence, it is needed to ensure software related availability and support services from Vendor. A comprehensive list of these elements is provided in Annexure-B.III of Agenda.

Powergrid member commented that the issue involved is related to meter where CTUIL comments also will be required for further deliberation but since member from CTUIL is not present they will not be able to comment further.

Member secretary NRPC directed that the agenda be taken in 67th NRPC Committee meeting.

3) Time drift intimation for IEM meters and action for correction

NRLDC stated that the data recorded by the Interface Energy Meters (IEMs) is time-stamped in 15- minute blocks. Therefore, maintaining accurate time synchronization in the meters is crucial since they are susceptible to time drift caused by variations in parameters such as temperature and humidity. The time drift in IEMs leads to discrepancies between the recorded meter readings and the actual readings, which in turn affects the calculation of actual drawal/injection of utilities and constituents.

NRLDC further stated that they are intimating all constituents and Utilities to check time drift of their respective IEM meter on weekly basis and send report to NRLDC on weekly basis about meter time drift along with weekly meter data .It has also been informed to take corrective actions at their end to rectify meter time drift as per norms and also inform NRLDC .However, NRLDC is not receiving report regarding Time drift of meters from many Utilities and Constituents even after frequent communication and follow up. A list of meters from where report received from Utilities and Constituents with time drift exceeding 1 minute is attached in Annexure B-IV of Agenda. Hence it is requested to all Utilities and Constituents to send Time drift report on weekly basis and take corrective actions to rectify time drift issue at their respective meters so as to avoid difference in actual meter data due to time drift which may lead to weekly accounting discrepancies and disputes later on if timely it is not being informed and resolved. All Utilities and Constituents to take measure regarding Time drift correction in meters timely and send weekly report to NRLDC.

All member agreed that Time drift issues have to be timely addressed by all utilities and report regarding it may be send to all concerned.

I/28865/2023

20. Frequent forced outages of transmission elements in the month of May'23:

The following transmission elements were frequently under forced outages during the month of **May'23**:

S. NO.	Element Name	No. of forced outages	Utility/ SLDC
1	220 KV Nara(UP)-Roorkee(UK) (UP) Ckt-1	4	UP/UK
2	220 KV Panipat(BB)-Narela(DV) (BBMB) Ckt-1	4	BBMB/Delhi
3	220 KV Singoli Bhatwari(Singoli(LTUHP))-Srinagar(UK) (PTCUL) Ckt-1	5	LTUHP/UK
4	220 KV Singoli Bhatwari(Singoli(LTUHP))-Srinagar(UK) (PTCUL) Ckt-2	6	LTUHP/UK
5	400 KV Agra-Unnao (UP) Ckt-1	3	UP
6	400 KV Akal-Jodhpur (RS) Ckt-1	6	Rajasthan
7	400 KV Anpara_B(UPUN)-Samath(UP) (UP) Ckt-2	3	UP
8	400 KV Bareilly-Unnao (UP) Ckt-2	3	UP
9	400 KV Bikaner(RS)-Deedwana(MTS) (RS) Ckt-1	4	Rajasthan
10	400 KV Kankani-Jaisalmer (RS) Ckt-2	3	Rajasthan
11	400 KV Merta-Kankani (RS) Ckt-1	4	Rajasthan
12	400 KV Suratgarh SCTPS(RVUN)-Bikaner(RS) (RS) Ckt-2	3	Rajasthan
13	400 KV Suratgarh(RVUN)-Ratangarh(RS) (RS) Ckt-2	3	Rajasthan

The complete details are attached at **Annexure-B.V** of Agenda.

Discussion during the meeting:

- **220 KV Nara(UP)-Roorkee(UK) (UP) Ckt-1:** *NRLDC representative raised concerned on frequent tripping of line and A/R operation. UP representative informed that patrolling was done and bird nests were found at cross-arm of tower no. 58 & 46, bird nests were removed. Regarding A/R operation, Uttarakhand representative informed that A/R at Roorkee end is functional and working properly, with respect to Nara end, UP representative informed that Main-1 relay is under repairing and A/R in Main-2 relay is not configured. He further informed that OEM would visit in 3-4 days to attend the issues. UP was requested to expedite the necessary actions and submit the remedial action taken report. UP agreed for the same.*

I/28865/2023

- **220 KV Panipat(BB)-Narela(DV) (BBMB) Ckt-1:** *NRLDC representative raised concerned on frequent tripping of line and A/R operation. BBMB representative informed that A/R at Panipat(BBMB) end is functional and working properly. Delhi representative informed that protection at Narela(DTL) end is maintained by BBMB. NRLDC representative requested BBMB to review the status of A/R operation at Narela(DTL) end and take necessary actions. BBMB agreed the same.*
- **220 KV Singoli Bhatwari(Singoli(LTUHP))-Srinagar(UK) (PTCUL) Ckt-1 & 2:** *Uttarakhand representative informed that jumper at few of the towers are oversized and were loose. It led to the faults due to snapping of jumper during inclement weather condition. He further informed that there is issue of A/R operation in line. NRLDC representative requested Uttarakhand to take necessary corrective actions to resolve the issue related to frequent faults due to snapping of jumper and A/R operation. He also requested to ensure the time syncing of DR as it was found that time is not synced. Uttarakhand agreed the same.*
- **400 KV Agra-Unnao (UP) Ckt-1:** *UP representative informed that tripping on 09th May occurred due to operator mistake during doing flag reset and 18:40 hrs tripping on 14th May occurred due to fault in reclaim time and at 02:47hrs occurred due to persistent fault, lien tripped after unsuccessful A/R operation. He further informed that patrolling was done however, no physical fault found at the fault location.*
- **220 KV 400 KV Akal-Jodhpur (RS) Ckt-1:** *NRLDC representative raised concerned on frequent tripping of line and A/R operation. Rajasthan representative informed that A/R at Jodhpur(RS) end is disabled due to issue in carrier communication issue. NRLDC representative requested Rajasthan to take necessary corrective actions to resolve the issue at the earliest and enable A/R operation. Rajasthan agreed the same.*
- **400 KV Anpara_B(UPUN)-Sarnath(UP) (UP) Ckt-2:** *NRLDC representative raised concerned on frequent tripping of line. UP representative informed that A/R is healthy and operational at both the ends. He further informed that patrolling was done, kite thread was found at fault location w.r.t. 18th May tripping and no physical fault was found w.r.t. 25th May tripping. It was informed that RoW has been ensured.*
- **400 KV Bareilly-Unnao (UP) Ckt-2:** *UP representative informed that A/R is healthy and working properly at Unnao(UP) end and there are issues at Bareilly end. He further informed that RoW is clear and no fault was found*

I/28865/2023

during patrolling. NRLDC representative asked about the status of actions at Barilley(UP) end as discussed in 207th OCC meeting. UP representative informed that they have followed up with the Bareilly(UP) however no communication regarding the same received from Bareilly(UP). He further stated that they will take up the issue further for corrective actions.

- **400 KV Bikaner(RS)-Deedwana(MTS) (RS) Ckt-1:** Rajasthan representative informed that line was charged through Tie CB only and on 2nd & 4th May line tripped along with 400kV Bikaner-SCTPS ckt-2 as both the lines were on same dia. He further informed that Main CB of 400kV Bikaner-Deedwana ckt-1 would be restored by 31st July, delay is due to unavailability of service engineer. With respect to issue of A/R operation, Rajasthan representative informed that A/R at Deedwana end is healthy however, issue is at Bikaner(RS) end due to SAS work. NRLDC representative requested Rajasthan to expedite the SAS work at Bikaner(RS) and enable A/R operation. Rajasthan agreed the same.
- **400 KV Kankani-Jaisalmer (RS) Ckt-2:** NRLDC representative raised concerned on frequent tripping of line and A/R operation. Rajasthan representative informed that A/R at both the ends are enabled however, A/R at Kankani(RS) end is not working properly. He further informed that issue has been taken up by protection wing for proper analysis and necessary actions. NRLDC representative also raised concern over time sync issue at both the ends. Rajasthan was requested to take necessary corrective actions to resolve the issue related to A/R operation and time sync of DR/EL at the earliest. Rajasthan agreed the same.
- **400 KV Merta-Kankani (RS) Ckt-1:** NRLDC representative raised concerned on frequent tripping of line and A/R operation. Rajasthan representative informed that A/R at Merta(RS) end is healthy and working properly however, there is issue in A/R operation at Kankani(RS) end. Rajasthan was requested to take necessary corrective actions to resolve the issue related to A/R operation at the earliest. Rajasthan agreed the same.
- **400kV Suratgarh(RVUN)-Ratangarh(RS) (RS) Ckt-2:** Rajasthan representative informed that tripping occurred due to maloperation of PLCC at Suratgarh end. As a remedial action, PLCC channel-2 has been kept out and no tripping was observed thereafter. NRLDC representative requested Rajasthan to PLCC channel-2 need to be correc and restored at the earliest. Rajasthan agreed the same.
- **400 KV Suratgarh(RVUN)-Ratangarh(RS) (RS) Ckt-2:** NRLDC representative raised concerned over non-submission of DR/EL. Rajasthan representative informed that tripping occurred due to over voltage protection operation at Ratangarh end. It was further informed that DR/EL not received

I/28865/2023

from Ratangarh end, they will follow-up again and share the tripping details at the earliest.

NRLDC representative emphasized that A/R (auto re-closer) issue was found in many of these tripping. He sensitized all the utilities to ensure healthiness/in service of A/R in 220 kV and above transmission lines in compliance to CEA Grid Standards. He further informed that most of the tripping are transient in nature but due to non-operation of A/R, it resulted into tripping of the transmission element thus reducing the reliability of the grid. All the utilities shall endeavor to keep auto re-closer in service and healthy condition of 220 kV and above voltage level transmission line. Issue of time syncing of DR/EL at many of the stations was highlighted, constituents were requested to ensure the time syncing of DR/EL. In addition, necessary actions also need to be taken to ensure the Right of Way to minimize the frequent faults in the line. All utilities agreed for the same.

OCC forum reiterate that frequent outages of such elements affect the reliability and security of the grid. Members were requested to look into such frequent outages and share the remedial measures taken/being taken in this respect.

21. Multiple element tripping events in Northern region in the month of May'23:

A total of **34** grid events occurred in the month of May'23 of which **01** is of GD-2 category, **11** are of GD-1 category, **12** are of GI-2 Category & **10** is of GI-1 category. The tripping report of all the events have been issued from NRLDC. A list of all these events is attached at **Annexure-B.VI** of Agenda.

Further, despite persistent discussions/follow-up in various OCC/PCC meetings, it is observed that provisions 5.2(r) and 5.9.4(d) of the IEGC, pertaining to reporting of events / tripping to RLDC, is not being complied with by many utilities.

Maximum fault duration observed is **3520msec** in the event of multiple element tripping at 220kV Dasuya(PS) at 04:48hrs on 31st May, 2023. During the event, 220 KV Dasuya-Alawalpur (PS) Ckt tripped on R-N phase to earth fault from Alawalpur end only; fault sensed in zone-1 from Alawalpur end. This fault was not sensed from Dasuya end. Hence distance protection did not operate and line did not trip from Dasuya end on this fault. On this fault, other lines from 200kV Dasuya(PS) tripped on back-up protection (Z-2/Z-3/directional E/F) operation from remote end only.

Regarding multiple elements tripping at 220kV Dasuya(PS), NRLDC representative raised concern over non-operation of main & back up protection of 220 KV Dasuya-Alawalpur (PS) ckt at Dasuya end. Punjab representative informed that local protection team reviewed the protection system at Dasuya end and no discrepancy was found. He further informed that M&P division would review the healthiness of protection system at Dasuya again and detailed analysis of the tripping event would be shared in 47th PSC meeting.

I/28865/2023

Delayed clearance of fault (more than 100ms for 400kV and 160ms for 220kV system) observed in total **13** events out of **34** grid events occurred in the month. The other events with delayed clearance of faults (>500ms) are as follows:

- i. Multiple elements tripping at 400/220kV Jodhpur(RS) at 20:14hrs on 24th May, 2023, fault clearance time: 2080msec
- ii. Multiple elements tripping at 220/66kV Ballabgarh(BB) at 01:52hrs on 16th May, 2023, fault clearance time: 1400msec
- iii. Multiple elements tripping at 220/132kV Barn(J&K) at 12:22hrs on 20th May, 2023, fault clearance time: 840msec
- iv. Multiple elements tripping at 220kV Bisnah(J&K) at 14:36hrs on 22nd May, 2023, fault clearance time: 840msec
- v. Multiple elements tripping at 220/66kV Mohali(PS) at 12:26hrs on 27th May, 2023, fault clearance time: 560msec

NRLDC representative requested concerned utilities to analyse the tripping incidents at their end and taken necessary actions to avoid the similar events in future. Also share the detailed report of the tripping incidents along with remedial action taken. Utilities agreed for the same.

OCC forum suggested all the NR constituents to update the information on tripping portal developed by NRLDC. All the constituents agreed to take proactive remedial actions in this regard to minimize the tripping.

Members were asked to take expeditious actions to avoid such tripping in future, Moreover, utilities may impress upon all concerned for providing the preliminary report, DR/EL & detailed Report of the events in line with the regulations. Members were further requested to ensure the time syncing of recording devices (DR, EL etc.) with GPS/NAVIK at substation of their respective control area. Members agreed to take action in this regard.

22. Details of tripping of Inter-Regional lines from Northern Region for May' 23:

A total of 28 inter-regional lines tripping occurred in the month of May'23. The list is attached at **Annexure-B.VII** of Agenda. The status of receipt of preliminary reports, DR/EL within 24hrs of the event and fault clearing time as per PMU data has also been mentioned in the table. The non-receipt of DR/EL & preliminary report within 24hrs of the event from SLDCs / ISTS licensees / ISGSs is in violation of regulation 5.2(r) of IEGC and regulation 15(3) of CEA Grid Standards. As per regulations, all the utilities shall furnish the DR/EL, flag details & preliminary report to RLDC/IPC within 24hrs of the event. They shall also furnish the detailed investigation report within 7 days of the event if fault clearance time is higher than that mandated by CEA (Grid Standard) Regulations.

I/28865/2023

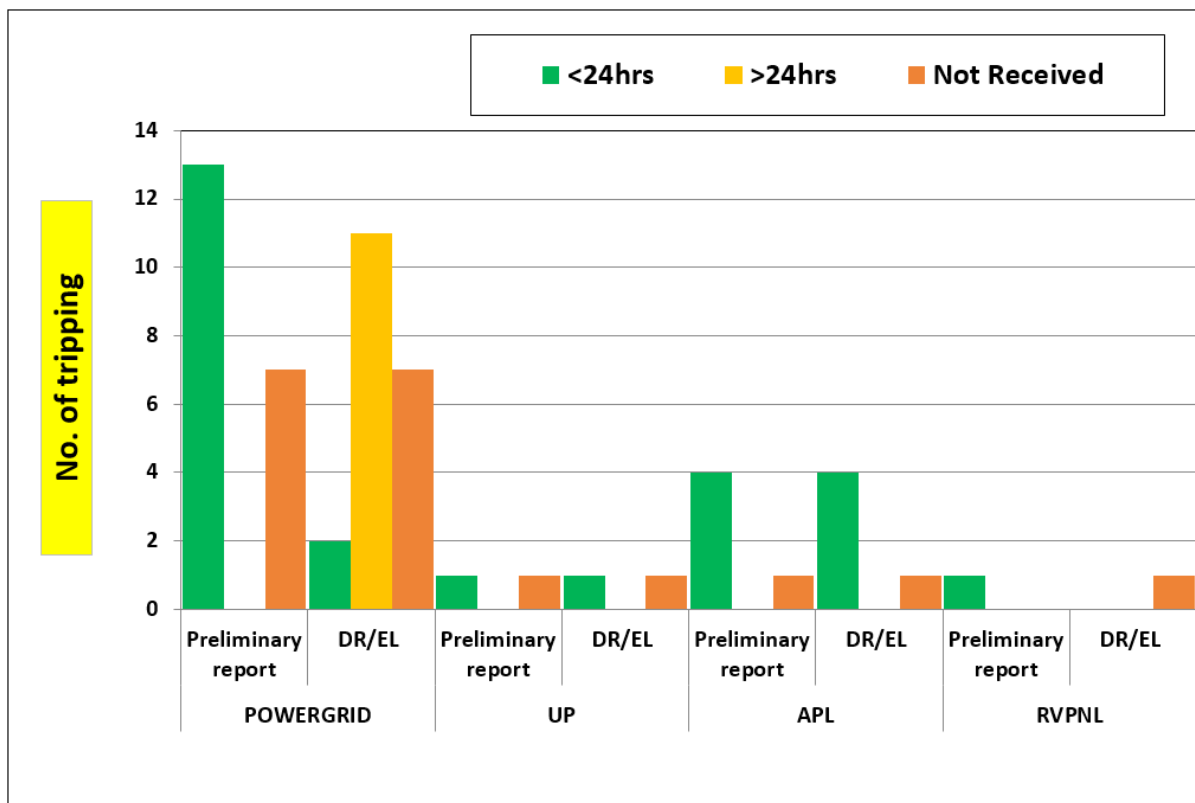

S. No.	Name of Transmission Element Tripped	Owner/Utility	Outage		Brief Reason (As reported)	*FIR Furnished (YES/NO)	DR/EL provided in 24 hrs (YES/NO)	inference from PMU, utility details	Remarks
			Date	Time					
1	220 KV Auraiya(NT)-Malanpur(MP) (PG) Ckt-1	POWERGRID	1-May-23	19:51	Phase to earth fault Y-N	YES	YES		As per DR of Auraiya end, Y-N fault with A/R start is observed. Complete A/R operation was not ascertained through DR as DR of only 1sec is available.
2	400 KV Kankroli-Zerda (PG) Ckt-1	POWERGRID	2-May-23	12:51	Phase to earth fault B-N	YES	YES (After 24hrs)	Reason of OV stage-1 protection operation.	As per DR of Kankroli end, B-N fault in Z-1, distance protection operated, however simultaneously OV stage-1 operated at Kankroli end and line tripped.
3	132 KV Rihand(UP)-Garwa(IS) (UP) Ckt-1	UPPTCL	4-May-23	11:34	Phase to earth fault R-N	YES	YES		As per DR report of Rihand end, R-N fault with fault distance of ~30.2km(29.6%) from Rihand end occurred.
4	800 KV HVDC Kurukshetra(PG) Pole-4	POWERGRID	10-May-23	22:24	Blocked due to software malfunction.	YES	YES (After 24hrs)		As per PMU, fluctuation in voltage is observed.
5	800 KV HVDC Kurukshetra(PG) Pole-2	POWERGRID	10-May-23	22:24	Blocked due to software malfunction.	YES	YES (After 24hrs)		
6	765 KV Fatehpur-Sasaram (PG) Ckt-1	POWERGRID	14-May-23	11:33	Line tripped at Fatehpur only due to DT received from Sasaram end.	YES	YES (After 24hrs)		As per PMU at Fatehpur(PG) no fault is observed, As per DR of Fatehpur end, no fault is observed. Line tripped on DT received from Sasaram end, voltage was in the operating range.

I/28865/2023

7	800 KV HVDC Kurukshetra(PG) Pole-1	POWERGRID	18-May-23	00:58	External blocked due to detection of smoke from switchyard during heavy windstorm in the area.	YES	YES (After 24hrs)	As per PMU, fluctuation in voltage is observed.
8	800 KV HVDC Kurukshetra(PG) Pole-4	POWERGRID	18-May-23	00:59	Blocked due to DC line fault in DMR-II.	YES	YES (After 24hrs)	
9	800 KV HVDC Kurukshetra(PG) Pole-03	POWERGRID	18-May-23	00:59	Blocked due to DC line fault in DMR-II.	YES	YES (After 24hrs)	
10	800 KV HVDC Kurukshetra(PG) Pole-2	POWERGRID	18-May-23	00:59	Blocked due to DC line fault in DMR-II.	YES	YES (After 24hrs)	
11	132 KV Anpara(UP)-Morwa(MP) (UP) Ckt-1	UPPTCL	24-May-23	10:53	O/C R-phase, 86 trip relay operated at Anpara(UP).	NO	NO	As per PMU at Varanasi(UP) no fault is observed.
12	500 KV HVDC Mahindergarh(APL)-Adani Mundra(APL) (ATIL) Ckt-2	APL	24-May-23	12:18	Tripped due to DC line fault.	YES	YES	As per EL, DC line fault occurred.
13	765 KV Fatehpur-Sasaram (PG) Ckt-1	POWERGRID	24-May-23	21:08	Tripped due to DT send from Fatehpur end. (D/T problem due to PLCC)	YES	YES (After 24hrs)	As per PMU at Fatehpur(PG) no fault is observed, As per DR of Fatehpur end, no fault is observed, voltage was also in the operating range. As per EL at Fatehpur(PG), differential protection operated at Fatehpur end and DT was sent to remote end.
14	800 KV HVDC Kurukshetra(PG) Pole-2	POWERGRID	25-May-23	09:25	Pole-2 blocked by CAT B from Pole-4	NO	NO	As per PMU, fluctuation in voltage is observed.
15	800 KV HVDC Kurukshetra(PG) Pole-1	POWERGRID	25-May-23	09:25	Pole-3 blocked due to DMR-2 transient fault.	NO	NO	
16	800 KV HVDC Kurukshetra(PG) Pole-03	POWERGRID	25-May-23	09:25	Pole-3 blocked due to DMR-2 transient fault.	NO	NO	
17	800 KV HVDC Kurukshetra(PG) Pole-4	POWERGRID	25-May-23	09:25	Pole-4 blocked due to issue in measurement panel DCCT.	NO	NO	

18	765 KV Phagi(RS)-Gwalior(PG) (PG) Ckt-1	POWERGRID	25-May-23	22:31	Line tripped on B-N Fault during heavy windstorm in the area. FLR- Gwalior- 306 Km/3.07Ka, Phagi-0.365Km/11.5 kA.	YES	YES	As per PMU at Bhiwani(PG) multiple B-N fault is observed. As per DR of Phagi end, line tripped on B-N fault in reclaim time.
19	400 KV RAPS_D(NP)-Shujalpur(PG) (RTCL) Ckt-2	POWERGRID	26-May-23	01:20	TEE-2 Protection operated at RAPP end and DT received at Shujalpur end.	NO	NO	As per PMU at Kota(PG), Y-B ph-ph fault with delayed clearance in 360msec is observed.
20	400 KV Kankroli- Zerda (PG) Ckt-1	POWERGRID	26-May-23	03:45	Line A/R successful at Kankroli, but tripped from Zerda. Dist. 44.1km, Fault current 6.7kA from Zerda.	YES	YES (After 24hrs)	As per PMU at Bhinmal(PG), Y-N fault is observed. As per DR of Kankroli end, successful A/R operation is observed. As per phase angle (90 degree), line tripped from Zerda end.
21	500 KV HVDC Mahindergarh(APL)-Adani Mundra(APL) (ATIL) Ckt-1	APL	26-May-23	10:45	Pole-1 tripped due to fault in VCS pump-2 at 10:45	YES	YES	As per EL, fault in VCS pump.
22	500 KV HVDC Mahindergarh(APL)-Adani Mundra(APL) (ATIL) Ckt-2	APL	26-May-23	16:19	HVDC Mundra- Mohindergarh Pole-1 tripped at 16:19 hrs after checking we have found that 220V DC power cable was found faulty	NO	NO	As per EL, fault in DC supply .
23	500 KV HVDC Mahindergarh(APL)-Adani Mundra(APL) (ATIL) Ckt-1	APL	26-May-23	16:19		YES	YES	
24	220 KV Ranpur(RS)-Bhanpura(MP) (RS) Ckt-1	RRVPLN	26-May-23	20:09	Relay Indication at Ranpur End: E/F in Y Phase Fault current, IL2: 0.61KA Zone 1 General trip, Dist:43.5km Relay Indication at Bhanpura End: E/F in B Phase B PH: 3242amps AR lockout Dist: 27.44Km	YES	NO	As per PMU, no fault is observed. DR/EL not received.
25	800 KV HVDC Kurukshetra(PG) Pole-01	POWERGRID	28-May-23	12:10	block command received from Champa end due to DC Filter overload protection operation at Champa end	NO	NO	As per PMU, fluctuation in voltage is observed.
26	800 KV HVDC Kurukshetra(PG) Pole-03	POWERGRID	28-May-23	12:10		NO	NO	
27	765 KV Agra-Gwalior (PG) Ckt-2	POWERGRID	29-May-23	15:26	tripped on Y-N fault .Gwalior end detail- F/D-117.0 KMS, F/C-5.85 KA and Agra end : fault distance- 2.4 Kms, FC=8KA	YES	YES (After 24hrs)	As per PMU at Bhiwani(PG) multiple Y-N fault is observed. As per DR of Agra end, line tripped on Y-N fault in reclaim time.
28	500 KV HVDC Mahindergarh(APL)-Adani Mundra(APL) (ATIL) Ckt-2	APL	31-May-23	17:03	HVDC Mundra- Mohindergarh Pole-2 tripped at 17:03 Hrs due to DC Line Fault	YES	YES	As per EL, DC line fault .

Discussion during the meeting:

- **765kV Fatehpur-Sasaram(PG) ckt-1:** POWERGRID representative informed that line tripped due to issue related to maloperation of PLCC and same would be resolved at the earliest. NRLDC representative highlighted that during last OCC meeting (207 OCC) also similar tripping was discussed

I/28865/2023

and it was informed that issue w.r.t PLCC has been resolved. POWERGRID is requested to do the root cause analysis and take necessary corrective actions to avoid such tripping in future. POWERGRID agreed for the same.

- **800kV HVDC Champa-Kurukshetra(PG):** POWERGRID representative informed that most of the tripping occurred due to software malfunction. OEM has done some changes in software, no tripping occurred thereafter. NRLDC representative requested POWERGRID to share the detail of issues along with remedial action taken report. POWERGRID agreed the same.
- **400kV Kankroli-Zerda(PG) ckt-1:** POWERGRID representative informed that there was some issue in timer of OV relay which led to instantaneous tripping of the line. It was further informed that issue related to timer has been resolved.
- **132kV Anpara(UP)-Morwa(MP) (UP) ckt:** UP representative informed that line is normally charged from Morwa end only.
- **220kV Ranpur(RS)-Bhanpura(MP) (RS) ckt:** Rajasthan representative informed that A/R is healthy and operational in line. DR/EL not received yet from Ranpur end. NRLDC representative requested Rajasthan to share the tripping details at the earliest. Rajasthan agreed for the same.

NRLDC representative requested members to advise the concerned for taking corrective action to avoid such tripping as well as timely submission of the information. Members agreed for the same.

OCC forum emphasized the importance of inter- regional links and requested all the concerned utilities to take necessary corrective to minimise the such tripping in future.

23. Status of submission of DR/EL and tripping report of utilities for the month of May'23.

The status of receipt of DR/EL and tripping report of utilities for the month of May'2023 is attached at **Annexure-B.VIII** of Agenda. It is to be noted that as per the IEGC provision under clause 5.2 (r), detailed tripping report along with DR & EL has to be furnished within 24 hrs of the occurrence of the event. However, it is evident from the submitted data that reporting status is not satisfactory and needs improvement.

NRLDC representative stated that reporting status has been improved from POWERGRID, UP, Delhi, Haryana, Rajasthan and Uttarakhand. However, reporting status from Punjab, HP, J&K & RE stations need improvement.

I/28865/2023

HP representative informed that issue has been taken up with the DISCOM for timely submission of the details so that details could be uploaded at tripping portal within stipulated time.

Punjab representative informed that continuous follow-ups are being done with the transmission wing to improve the tripping details submission status.

OCC forum emphasized the importance of DR/EL & tripping report data for analysis of the trippings. In addition, these data are also base for the availability verification. Unavailability of these details delays the availability verification process also. Hence, timely submission of DR/EL & tripping report is very much necessary. Members were requested to comply the IEGC 5.2(r) and submit the details in time. Members agreed to take necessary follow-up actions to improve the reporting status

Members may please note and advise the concerned for timely submission of the information. It is requested that DR/EL of all the trippings shall be uploaded on Web Based Tripping Monitoring System “<http://103.7.128.184/Account/Login.aspx>” within 24 hours of the events as per IEGC clause 5.2.r and clause 15.3 of CEA grid standard. Apart from prints of DR outputs, the corresponding COMTRADE files may please also be submitted in tripping portal / through email.

24. Status of PSS tuning/ re-tuning and Step Response Test of generator

Since 182nd OCC meeting, this point was discussed and Utilities were requested to submit the present status of PSS tuning/re-tuning and Step Response Test of their respective generators as per the below mentioned format.

S. No	Name of the Generating Station	Date of last PSS tuning / re-tuning performed (in DD/MM/YYYY format)	Date of last Step Response Test performed (in DD/MM/YYYY format)	Report submitted to NRLDC (Yes/ No)	Remarks (if any)

The status of test performed till date is attached at **Annexure-B.IX** of Agenda.

It is to be noted that as per regulation 5.2(k) of IEGC, Power System Stabilizers (PSS) in AVR of generating units (wherever provided), shall be got properly tuned by the respective generating unit owner as per a plan prepared for the purpose by the CTU/PC from time to time.

Members were requested to update about their future plan for PSS tuning as there is no significant progress despite including this agenda in every OCC meeting and a separate meeting may be called for detail discussion on this matter.

I/28865/2023

NRLDC representative informed that all the units who have done Step response test before 2018 were requested to plan the exciter step-response test as soon as possible and submit the tentative schedule of step-response test on the units with NRPC/ NRLDC.

OCC forum deliberated that members may kindly accord due priority in this regard and update about their future plan for PSS tuning as there is little progress despite including this agenda in every OCC meeting. Members agreed for the same.

25. Frequency response characteristic:

Two FRC based event occurred in the month of **May-2023**. Description of the event is as given below:

Table:

S. No.	Event Date	Time (In hrs.)	Event Description	Starting Frequency (in Hz)	End Frequency (in Hz)	Δf	NR FRC during the event (%)
1	01-May-23	13:23hrs	On 01 st May,2023 at 13:23 hrs, as reported, 765 KV AJMER(PG)-PHAGI(RS) (PAPTL) CKT-1, 765 KV FATEHGARH_II(PG)-BHADLA(PG) (FBTL) CKT-1, 765 KV AJMER-BHADLA_2 (PG) CKT-1tripped on over-voltage. This led to the solar generation loss of approx. 1100MW .Hence, generation loss of 1100MW has been considered for FRC calculation.	50.18	50.13	0.05	51
2	15-	11:51hr	On 15th May,	49.98	49.76	0.22	

I/28865/2023

	May-23	s	<p>2023, at 11:51:55 hrs, 765kV Bhadla-Bikaner ckt-1 tripped on Y-B phase to phase fault during inclement weather condition (wind/dust storm), fault distance was ~111.6km from Bikaner end (line length is ~169km). On this fault during voltage dip, significant dip in RE generation observed. Voltage dipped up to 0.65pu (as per PMU at Fatehgarh2). Due to significant dip in RE generation and de-loading of 765kV EHV lines, over voltage (>1.1pu at 765kV & 400kV level at RE Pooling stations) scenario created immediately after the fault that led to multiple element tripping in the RE complex. As per PMU & SCADA, total drop in RE generation was approx.7120MW (~6410MW ISTS RE generation and ~710MW Rajasthan RE generation). Hence, generation loss of 7120MW</p>			24
--	--------	---	---	--	--	----

I/28865/2023

			has been considered for FRC calculation.				
--	--	--	--	--	--	--	--

Status of Data received till date for 01st May 2023 event:

Status of Field Data received of FRC of Grid event occurred at RE complex in Rajasthan in Northern Region at 13:23 Hrs on 01.05.2023			
Data Received from		Data Not Received from	
Koteshwar HEP	TSPL	Uttarakhand	APCPL Jhajjar
UP	Rajasthan	Haryana	Rihand NTPC
BBMB	NHPC	Punjab	Unchhahar NTPC
Delhi	HP		Tehri HEP
			Kawai TPS
			Singrauli NTPC
			Dadri NTPC

FRC as per NR SCADA data:

Generator	01-May-23 event	Generator	01-May-23 event
Singrauli TPS	33%	Salal HEP	5%
Rihand-1 TPS	-19%	Tanakpur HEP	-4%
Rihand-2 TPS	-1%	Uri-1 HEP	47%
Rihand-3 TPS	9%	Uri-2 HEP	0%
Dadri-1 TPS	-74%	Dhauliganga HEP	No generation
Dadri -2 TPS	78%	Dulhasti HEP	No generation
Unchahar TPS	-31%	Sewa-II HEP	0%
Unchahar stg-4 TPS	No generation	Parbati-3 HEP	No generation
Jhajjar TPS	114%	Jhakri HEP	No generation
Dadri GPS	No generation	Rampur HEP	No generation
Anta GPS	No generation	Tehri HEP	No generation
Auraiya GPS	No generation	Koteswar HEP	0%
Narora APS	-4%	Karcham HEP	186%
RAPS-B	-4%	Malana-2 HEP	No generation
RAPS-C	13%	Budhil HEP	No generation
Chamera-1 HEP	No generation	Bhakra HEP	8%
Chamera-2 HEP	No generation	Dehar HEP	7%
Chamera-3 HEP	No generation	Pong HEP	No generation
Bairasiul HEP	No generation	Koldam HEP	No generation
		AD Hydro HEP	No generation

I/28865/2023

Generator	01-May-23 event	Generator	01-May-23 event
PUNJAB		UP	
Ropar TPS	No generation	Obra TPS	1%
L.Mohabbat TPS	No generation	Harduaganj TPS	No generation
Rajpura TPS	-68%	Paricha TPS	No generation
T.Sabo TPS	25%	Rosa TPS	7%
Goindwal Sahib TPS	0%	Anpara TPS	-14%
Ranjit Sagar HEP	31%	Anpara C TPS	47%
Anandpur Sahib HEP	-4%	Anpara D TPS	29%
HARYANA		Bara TPS	0%
Panipat TPS	-8%	Lalitpur TPS	-2%
Khedar TPS	No generation	Meja TPS	-16%
Yamuna Nagar TPS	No generation	Vishnuprayag HEP	0%
CLP Jhajjar TPS	38%	Alaknanda HEP	2%
Faridabad GPS	No generation	Rihand HEP	No generation
RAJASTHAN		Obra HEP	No generation
Kota TPS	16%	UTTARAKHAND	
Suratgarh TPS	No generation	Gamma Infra GPS	No generation
Kalisindh TPS	20%	Shravanti GPS	No generation
Chhabra TPS	No generation	Ramganga HEP	40%
Chhabra stg-2 TPS	79%	Chibra HEP	0%
Kawai TPS	-5%	Khodri HEP	-20%
Dholpur GPS	No generation	Chilla HEP	21%
Mahi-1 HEP	No generation	HP	
Mahi-2 HEP	No generation	Baspa HEP	7%
RPS HEP	No generation	Malana HEP	No generation
JS HEP	No generation	Sainj HEP	No generation
DELHI		Larji HEP	24%
Bawana GPS	0%	Bhabha HEP	0%
Pragati GPS	No generation	Giri HEP	31%
		J&K	
		Baglihar-1&2 HEP	No generation
		Lower Jhelum HEP	No generation

Status of Data received till date for 15th May 2023 event:

I/28865/2023

Status of Field Data received of FRC of Grid event occurred at RE complex in Rajasthan in Northern Region at 11:51 Hrs on 15.05.2023			
Data Received from		Data Not Received from	
Koteshwar HEP	Rajasthan	Uttarakhand	APCPL Jhajjar
UP	NHPC	Haryana	Rihand NTPC
BBMB	Kawai TPS	Punjab	Unchhahar NTPC
Delhi	NJPC		Tehri HEP
Karcham Wangtoo HEP	Singrauli NTPC		TSPL
	HP		Dadri NTPC

FRC as per NR SCADA data:

Generator	15-May-23 event	Generator	15-May-23 event
Singrauli TPS	10%	Salal HEP	5%
Rihand-1 TPS	26%	Tanakpur HEP	0%
Rihand-2 TPS	-31%	Uri-1 HEP	34%
Rihand-3 TPS	-14%	Uri-2 HEP	5%
Dadri-1 TPS	61%	Dhauliganga HEP	No generation
Dadri -2 TPS	104%	Dulhasti HEP	29%
Unchahar TPS	4%	Sewa-II HEP	10%
Unchahar stg-4 TPS	64%	Parbati-3 HEP	No generation
Jhajjar TPS	83%	Jhakri HEP	99%
Dadri GPS	No generation	Rampur HEP	Suspected SCADA data
Anta GPS	No generation	Tehri HEP	No generation
Auraiya GPS	No generation	Koteswar HEP	0%
Narora APS	2%	Karcham HEP	123%
RAPS-B	0%	Malana-2 HEP	No generation
RAPS-C	3%	Budhil HEP	No generation
Chamera-1 HEP	No generation	Bhakra HEP	-2%
Chamera-2 HEP	5%	Dehar HEP	2%
Chamera-3 HEP	50%	Pong HEP	-1%
Bairasiul HEP	0%	Koldam HEP	No generation
		AD Hydro HEP	No generation

I/28865/2023

Generator	15-May-23 event	Generator	15-May-23 event
PUNJAB		UP	
Ropar TPS	1%	Obra TPS	-1%
L.Mohabbat TPS	36%	Harduaganj TPS	80%
Rajpura TPS	0%	Paricha TPS	-6%
T.Sabo TPS	4%	Rosa TPS	8%
Goindwal Sahib TPS	99%	Anpara TPS	4%
Ranjit Sagar HEP	25%	Anpara C TPS	2%
Anandpur Sahib HEP	1%	Anpara D TPS	4%
HARYANA		Bara TPS	20%
Panipat TPS	-4%	Lalitpur TPS	29%
Khedar TPS	-6%	Meja TPS	25%
Yamuna Nagar TPS	No generation	Vishnuprayag HEP	0%
CLP Jhajjar TPS	28%	Alaknanda HEP	-8%
Faridabad GPS	No generation	Rihand HEP	No generation
RAJASTHAN		Obra HEP	No generation
Kota TPS	0%	UTTARAKHAND	
Suratgarh TPS	-2%	Gamma Infra GPS	1%
Kalisindh TPS	-24%	Shravanti GPS	0%
Chhabra TPS	No generation	Ramganga HEP	No generation
Chhabra stg-2 TPS	-10%	Chibra HEP	5%
Kawai TPS	98%	Khodri HEP	5%
Dholpur GPS	No generation	Chilla HEP	-1%
Mahi-1 HEP	No generation	HP	
Mahi-2 HEP	No generation	Baspa HEP	-2%
RPS HEP	No generation	Malana HEP	No generation
JS HEP	No generation	Sainj HEP	-4%
DELHI		Larji HEP	10%
Bawana GPS	0%	Bhabha HEP	0%
Pragati GPS	339%	Giri HEP	No generation
		J&K	
		Baglihar-1&2 HEP	No generation
		Lower Jhelum HEP	No generation

NRLDC representative requested all the constituents to timely share the details of FRC w.r.t. their control area and also analyse the FRC of generating units of their control area.

OCC forum further requested to take corrective actions and also take initiative of conducting PFR testing of generating units for further turning and improvement. Constituents agreed for the same

26. UFR & df/dt operation on 15th May 2023

On 15th May 2023, at 11:51hrs, grid disturbance of category GD-2 occurred in Rajasthan Renewable Energy (RE) complex. Event triggered by Y-B (L-L) fault in 765kV Bhadla-Bikaner (PG) ckt-1. On this fault, during voltage dip, significant dip in RE generation observed. Due to significant dip in RE generation and de-loading of 765kV EHV lines, over voltage occurred immediately after the fault that led to tripping of multiple 765kV ISTS lines at 765kV pooling stations in Rajasthan RE generation complex. As per PMU & SCADA, total drop in RE generation was approx.7120MW.

During the event, due to significant drop in RE generation, frequency dropped from 49.98Hz to 49.4Hz. On this frequency drop, load relief was observed on operation of UFR stage-1 & df/dt.

I/28865/2023

State wise summary of UFR & df/dt operation during the event is shown in below table:

Region wise load relief on UFR & df/dt operation at 11:51 hrs on 15th May 2023				
State	UFR stage-1		df/dt stage-1	
	Approved load relief	Actual load relief	Approved load relief	Actual load relief
Uttar Pradesh	1331	1038	592	291
Rajasthan	548	161	286	272
Haryana	308	50	280	Nil
Punjab	400	300 (as per SCADA)	430	
HP	128	Nil	50	
Uttarakhand	77	114	70	
Delhi	291	54	211	
J&K/Ladakh	83	Details not received	90	
Chandigarh	16		0	
Total	3182	1717	2009	563

Details of quantum of load relief not received from J&K & Punjab and operation of df/dt reported from UP & Rajasthan only.

NRLDC representative stated that some of the state i.e., Haryana, Punjab, Uttarakhand, and Delhi didn't report tripping from df/dt operation and HP didn't report tripping from UFR as well as from df/dt. In addition, there is significant variation between actual approved load relief quantum and actual load relief during the event.

Haryana representative informed that M&P wing has been asked to review the operation of UFR & df/dt operation.

HP representative stated that they will follow-up with the DISCOM to review the same.

Delhi representative informed that reported MW relief (54MW) was actually occurred on df/dt operation and tripping from UFR not reported. NRLDC asked Delhi to review the operation of UFR operation. Delhi agreed for the same.

I/28865/2023

OCC forum requested all the constituents to review the operation of UFR & df/dt operation in their respective control area and take necessary corrective action to ensure their proper operation. Constituents agreed for the same.

27. Status of Bus bar protection:

Clause - 4 in schedule - V of Central Electricity Authority (Technical Standards for Construction of Electrical Plants and Electric Lines) Regulations, 2010 reads as

"Bus bar protection and local breaker backup protection shall be provided in 220kV and higher voltage interconnecting sub- stations as well as in all generating station switchyards".

During analysis of many grid incidents/disturbances, it has been found that the Busbar protection at the affected substation was **not present or non-operational** which resulted in considerably increasing both the number of affected elements and fault clearance time. Accordingly, it becomes critical to monitor and keep Busbar protection at all the 220 kV and above voltage level substations healthy and operational.

Constituents were requested vide NRLDC letter dated 28th Dec 2022 to furnish status of Busbar protection in the following format in your control area.

Details are yet to be received from Rajasthan, J&K & Delhi.

Constituent wise status of bus bar protection where bus bar protection is either not installed or installed but not operational is attached as **Annexure-B.X** of Agenda.

NRLDC representative stated that constituents agreed in last OCC meeting to share the current status of the bus bar protection, however details received from Uttarakhand only as of now.

Delhi representative informed that only 220kV Sabjumandi & Rajghat S/s don't have bus bar protection scheme. At 220kV Sabjimandi S/s elements are connected at single bus only and at 220kV Rajghat S/s, line and transformer bay are connected together so bus bar protection is not feasible at both these S/s as of now. Rest of the stations have bus bar protection operational.

HP representative informed that issue w.r.t. bus bar protection at 220kV Chamba has been taken up with OEM, feedback from OEM yet to be received. At remaining 04 stations, ABB has started the review work and within 02 months all the bus bar protection will be made operational.

I/28865/2023

Punjab representative informed that 09 stations don't have bus bar protection and within next 06 months (by Dec 2023) bus bar protection will be commissioned at these 09 substations.

NRLDC requested all the concerned members to share the current status of bus bar protection w.r.t. their control area.

OCC forum requested all the constituents to update the status of bus bar protection at S/s of their control area and also expedite the commissioning and implementation work of bus bar protection system. Members agreed for the same.

28. Frequent 800kV HVDC Champa-Kurukshetra inter-regional link:

It has been observed that frequency of tripping of HVDC Champa-Kurukshetra has increased. There are 13 no of trippings has been observed in this link since May 2023. List of all the tripping of HVDC Champa-Kurukshetra is enclosed as **Annexure-B.XI** of Agenda. The tripping of this high capacity link may cause overloading of other parallel transmission lines and further tripping may cause cascade tripping.

It is also well known that, paddy season is on the verge of start in Haryana & Punjab and on account of summer, the Northern Region load would remain high till September and therefore, high import requirement exists for the Northern Region. Thus, the HVDC Champa-Kurukshetra inter-regional link is a very important link for fulfilling the Northern Region demand requirement.

It has been observed that major fault is either due to DC line fault, filter protection, software issues, protection mal-operation etc. The reason of most of the tripping seems similar indicating the repetitive nature of fault/tripping.

POWERGRID(NR-1) is requested to take necessary corrective actions to avoid frequent tripping of this inter-regional link.

POWERGRID representative informed that most of the tripping occurred due to software malfunction. OEM has done some changes in software, no tripping occurred thereafter. NRLDC representative requested POWERGRID to share the detail of issues along with remedial action taken report. POWERGRID agreed the same.

OCC forum emphasized on the importance of Champa-Kurukshetra HVDC link and requested POWERGRID to take necessary corrective actions to ensure its reliability.

Follow up issues from previous OCC meetings

Annexure-A. I

1	Down Stream network by State utilities from ISTS Station	Augmentation of transformation capacity in various existing substations, addition of new substations along with line bays as well as requirement of line bays by STUs for downstream network are under implementation at various locations in Northern Region. Further, 220kV bays have already been commissioned at various substations in NR. For its utilization, downstream 220kV system needs to be commissioned.	List of downstream networks is enclosed in Annexure-A. I. I.																																								
2	Progress of installing new capacitors and repair of defective capacitors	Information regarding installation of new capacitors and repair of defective capacitors is to be submitted to NRPC Secretariat.	<p>Data upto following months, received from various states / UTs:</p> <table border="1" data-bbox="951 801 1548 1070"> <tr><td>⊙ CHANDIGARH</td><td>Sep-2019</td></tr> <tr><td>⊙ DELHI</td><td>Mar-2023</td></tr> <tr><td>⊙ HARYANA</td><td>May-2023</td></tr> <tr><td>⊙ HP</td><td>Jan-2023</td></tr> <tr><td>⊙ J&K and LADAKH</td><td>Not Available</td></tr> <tr><td>⊙ PUNJAB</td><td>Jan-2023</td></tr> <tr><td>⊙ RAJASTHAN</td><td>May-2023</td></tr> <tr><td>⊙ UP</td><td>May-2023</td></tr> <tr><td>⊙ UTTARAKHAND</td><td>Apr-2023</td></tr> </table> <p>All States/UTs are requested to update status on monthly basis.</p>	⊙ CHANDIGARH	Sep-2019	⊙ DELHI	Mar-2023	⊙ HARYANA	May-2023	⊙ HP	Jan-2023	⊙ J&K and LADAKH	Not Available	⊙ PUNJAB	Jan-2023	⊙ RAJASTHAN	May-2023	⊙ UP	May-2023	⊙ UTTARAKHAND	Apr-2023																						
⊙ CHANDIGARH	Sep-2019																																										
⊙ DELHI	Mar-2023																																										
⊙ HARYANA	May-2023																																										
⊙ HP	Jan-2023																																										
⊙ J&K and LADAKH	Not Available																																										
⊙ PUNJAB	Jan-2023																																										
⊙ RAJASTHAN	May-2023																																										
⊙ UP	May-2023																																										
⊙ UTTARAKHAND	Apr-2023																																										
3	Healthiness of defence mechanism: Self-certification	<p>Report of mock exercise for healthiness of UFRs carried out by utilities themselves on quarterly basis is to be submitted to NRPC Secretariat and NRLDC. All utilities were advised to certify specifically, in the report that “All the UFRs are checked and found functional” .</p> <p>In compliance of NPC decision, NR states/constituents agreed to raise the AUFRR settings by 0.2 Hz in 47th TCC/49th NRPC meetings.</p>	<p>Data upto following months, received from various states / UTs:</p> <table border="1" data-bbox="951 1261 1548 1563"> <tr><td>⊙ CHANDIGARH</td><td>Not Available</td></tr> <tr><td>⊙ DELHI</td><td>Mar-2023</td></tr> <tr><td>⊙ HARYANA</td><td>Mar-2023</td></tr> <tr><td>⊙ HP</td><td>May-2023</td></tr> <tr><td>⊙ J&K and LADAKH</td><td>Not Available</td></tr> <tr><td>⊙ PUNJAB</td><td>Mar-2023</td></tr> <tr><td>⊙ RAJASTHAN</td><td>Mar-2023</td></tr> <tr><td>⊙ UP</td><td>Mar-2023</td></tr> <tr><td>⊙ UTTARAKHAND</td><td>Mar-2023</td></tr> <tr><td>⊙ BBMB</td><td>Mar-2023</td></tr> </table> <p>All States/UTs are requested to update status for healthiness of UFRs on monthly basis for islanding schemes and on quarterly basis for the rest .</p> <p>Status:</p> <table border="1" data-bbox="951 1776 1548 2078"> <tr><td>⊙ CHANDIGARH</td><td>Not Available</td></tr> <tr><td>⊙ DELHI</td><td>Increased</td></tr> <tr><td>⊙ HARYANA</td><td>Increased</td></tr> <tr><td>⊙ HP</td><td>Increased</td></tr> <tr><td>⊙ J&K and LADAKH</td><td>Not increased</td></tr> <tr><td>⊙ PUNJAB</td><td>Increased</td></tr> <tr><td>⊙ RAJASTHAN</td><td>Increased</td></tr> <tr><td>⊙ UP</td><td>Increased</td></tr> <tr><td>⊙ UTTARAKHAND</td><td>Increased</td></tr> <tr><td>⊙ BBMB</td><td>Increased</td></tr> </table> <p>J&K and LADAKH were requested to update status for increasing settings of UFRs.</p>	⊙ CHANDIGARH	Not Available	⊙ DELHI	Mar-2023	⊙ HARYANA	Mar-2023	⊙ HP	May-2023	⊙ J&K and LADAKH	Not Available	⊙ PUNJAB	Mar-2023	⊙ RAJASTHAN	Mar-2023	⊙ UP	Mar-2023	⊙ UTTARAKHAND	Mar-2023	⊙ BBMB	Mar-2023	⊙ CHANDIGARH	Not Available	⊙ DELHI	Increased	⊙ HARYANA	Increased	⊙ HP	Increased	⊙ J&K and LADAKH	Not increased	⊙ PUNJAB	Increased	⊙ RAJASTHAN	Increased	⊙ UP	Increased	⊙ UTTARAKHAND	Increased	⊙ BBMB	Increased
⊙ CHANDIGARH	Not Available																																										
⊙ DELHI	Mar-2023																																										
⊙ HARYANA	Mar-2023																																										
⊙ HP	May-2023																																										
⊙ J&K and LADAKH	Not Available																																										
⊙ PUNJAB	Mar-2023																																										
⊙ RAJASTHAN	Mar-2023																																										
⊙ UP	Mar-2023																																										
⊙ UTTARAKHAND	Mar-2023																																										
⊙ BBMB	Mar-2023																																										
⊙ CHANDIGARH	Not Available																																										
⊙ DELHI	Increased																																										
⊙ HARYANA	Increased																																										
⊙ HP	Increased																																										
⊙ J&K and LADAKH	Not increased																																										
⊙ PUNJAB	Increased																																										
⊙ RAJASTHAN	Increased																																										
⊙ UP	Increased																																										
⊙ UTTARAKHAND	Increased																																										
⊙ BBMB	Increased																																										

4	<p>Status of FGD installation vis-à-vis installation plan at identified TPS</p>	<p>List of FGDs to be installed in NR was finalized in the 36th TCC (special) meeting dt. 14.09.2017. All SLDCs were regularly requested since 144th OCC meeting to take up with the concerned generators where FGD was required to be installed.</p> <p>Further, progress of FGD installation work on monthly basis is monitored in OCC meetings.</p>	<p>Status of the information submission (month) from states / utilities is as under:</p> <table border="1" data-bbox="948 344 1554 501"> <tr><td>⊙ HARYANA</td><td>Sep-2022</td></tr> <tr><td>⊙ PUNJAB</td><td>May-2023</td></tr> <tr><td>⊙ RAJASTHAN</td><td>May-2023</td></tr> <tr><td>⊙ UP</td><td>May-2023</td></tr> <tr><td>⊙ NTPC</td><td>Feb-2023</td></tr> </table> <p>FGD status details are enclosed as Annexure-A. I. II.</p> <p>All States/utilities are requested to update status of FGD installation progress on monthly basis.</p>	⊙ HARYANA	Sep-2022	⊙ PUNJAB	May-2023	⊙ RAJASTHAN	May-2023	⊙ UP	May-2023	⊙ NTPC	Feb-2023																								
⊙ HARYANA	Sep-2022																																				
⊙ PUNJAB	May-2023																																				
⊙ RAJASTHAN	May-2023																																				
⊙ UP	May-2023																																				
⊙ NTPC	Feb-2023																																				
5	<p>Submission of breakup of Energy Consumption by the states</p>	<p>All states/UTs are requested to submit the requisite data as per the billed data information in the format given as under:</p> <table border="1" data-bbox="384 869 948 1037"> <thead> <tr> <th>Category→</th> <th>Consumption by Domestic Loads</th> <th>Consumption by Commercial Loads</th> <th>Consumption by Agricultural Loads</th> <th>Consumption by Industrial Loads</th> <th>Traction supply load</th> <th>Miscellaneous / Others</th> </tr> </thead> <tbody> <tr> <td><Month></td> <td></td> <td></td> <td></td> <td></td> <td></td> <td></td> </tr> </tbody> </table>	Category→	Consumption by Domestic Loads	Consumption by Commercial Loads	Consumption by Agricultural Loads	Consumption by Industrial Loads	Traction supply load	Miscellaneous / Others	<Month>							<p>Status of the information submission (month) from states / utilities is as under:</p> <table border="1" data-bbox="948 837 1554 1160"> <thead> <tr> <th>State / UT</th> <th>Upto</th> </tr> </thead> <tbody> <tr><td>⊙ CHANDIGARH</td><td>Not Submitted</td></tr> <tr><td>⊙ DELHI</td><td>Feb-23</td></tr> <tr><td>⊙ HARYANA</td><td>Mar-23</td></tr> <tr><td>⊙ HP</td><td>Mar-23</td></tr> <tr><td>⊙ J&K and LADAKH</td><td>Not Submitted</td></tr> <tr><td>⊙ PUNJAB</td><td>Apr-23</td></tr> <tr><td>⊙ RAJASTHAN</td><td>Apr-23</td></tr> <tr><td>⊙ UP</td><td>Jan-23</td></tr> <tr><td>⊙ UTTARAKHAND</td><td>Mar-23</td></tr> </tbody> </table> <p>J&K and Ladakh and Chandigarh are requested to submit the requisite data w.e.f. April 2018 as per the billed data information in the given format</p>	State / UT	Upto	⊙ CHANDIGARH	Not Submitted	⊙ DELHI	Feb-23	⊙ HARYANA	Mar-23	⊙ HP	Mar-23	⊙ J&K and LADAKH	Not Submitted	⊙ PUNJAB	Apr-23	⊙ RAJASTHAN	Apr-23	⊙ UP	Jan-23	⊙ UTTARAKHAND	Mar-23
Category→	Consumption by Domestic Loads	Consumption by Commercial Loads	Consumption by Agricultural Loads	Consumption by Industrial Loads	Traction supply load	Miscellaneous / Others																															
<Month>																																					
State / UT	Upto																																				
⊙ CHANDIGARH	Not Submitted																																				
⊙ DELHI	Feb-23																																				
⊙ HARYANA	Mar-23																																				
⊙ HP	Mar-23																																				
⊙ J&K and LADAKH	Not Submitted																																				
⊙ PUNJAB	Apr-23																																				
⊙ RAJASTHAN	Apr-23																																				
⊙ UP	Jan-23																																				
⊙ UTTARAKHAND	Mar-23																																				
6	<p>Information about variable charges of all generating units in the Region</p>	<p>The variable charges detail for different generating units are available on the MERIT Order Portal.</p>	<p>All states/UTs are requested to submit daily data on MERIT Order Portal timely.</p>																																		
7	<p>Status of Automatic Demand Management System in NR states/UT's</p>	<p>The status of ADMS implementation in NR, which is mandated in clause 5.4.2 (d) of IEGC by SLDC/SEB/DISCOMs is presented in the following table:</p>	<p>Status:</p> <table border="1" data-bbox="948 1518 1554 1852"> <tr><td>⊙ DELHI</td><td>Fully implemented</td></tr> <tr><td>⊙ HARYANA</td><td>Scheme not implemented</td></tr> <tr><td>⊙ HP</td><td>Scheme not implemented</td></tr> <tr><td>⊙ PUNJAB</td><td>Scheme not implemented</td></tr> <tr><td>⊙ RAJASTHAN</td><td>Under implementation. Likely completion schedule is 30.06.2023.</td></tr> <tr><td>⊙ UP</td><td>Scheme implemented by NPCIL only</td></tr> </table>	⊙ DELHI	Fully implemented	⊙ HARYANA	Scheme not implemented	⊙ HP	Scheme not implemented	⊙ PUNJAB	Scheme not implemented	⊙ RAJASTHAN	Under implementation. Likely completion schedule is 30.06.2023.	⊙ UP	Scheme implemented by NPCIL only																						
⊙ DELHI	Fully implemented																																				
⊙ HARYANA	Scheme not implemented																																				
⊙ HP	Scheme not implemented																																				
⊙ PUNJAB	Scheme not implemented																																				
⊙ RAJASTHAN	Under implementation. Likely completion schedule is 30.06.2023.																																				
⊙ UP	Scheme implemented by NPCIL only																																				

8	Reactive compensation at 220 kV/ 400 kV level at 15 substations			
	State / Utility	Substation	Reactor	Status
i	POWERGRID	Kurukshetra	500 MVar TCR	Anticipated commissioning: Jul'23
ii	DTL	Peeragarhi	1x50 MVar at 220 kV	PO awarded to M/s Kanohar Electricals Ltd. Drawings approved and under final stage inspection. GIS Bay is already available.
iii	DTL	Harsh Vihar	2x50 MVar at 220 kV	PO awarded to M/s Kanohar Electricals Ltd. Drawings approved and under final stage inspection. GIS Bay is already available.
iv	DTL	Mundka	1x125 MVar at 400 kV & 1x25 MVar at 220 kV	Bay work awarded to M/s. Ethos. Bay work is expected to be completed by Dec.21. Reactor part tender is dropped and at present same is under revision.
v	DTL	Bamnauli	2x25 MVar at 220 kV	Bay work awarded to M/s. Ethos. Bay work is expected to be completed by Dec.21. Reactor part tender is dropped and at present same is under revision.
vi	DTL	Indraprastha	2x25 MVar at 220 kV	Bay work awarded to M/s. Ethos. Bay work is expected to be completed by Dec.21. Reactor part tender is dropped and at present same is under revision.
vii	DTL	Electric Lane	1x50 MVar at 220 kV	Under Re-tendering due to Single Bid
viii	PUNJAB	Dhuri	1x125 MVar at 400 kV & 1x25 MVar at 220 kV	400kV Reactors - LOA issued on dated. 17.08.2021 and date of completion of project is 18 months from the date of LOA. 220kV Reactors - LOA issued on dated 19.07.2021 and date of completion of project is 18 months from the date of LOA. Commsioned 27th Jan'23
ix	PUNJAB	Nakodar	1x25 MVar at 220 kV	1x25 MVAR Reactor at Nakodar has been commissioned on dated 13th February' 2023.
x	PTCUL	Kashipur	1x125 MVAR at 400 kV	Price bid has been opened and is under evaluation. Retendered in Jan'23
xi	RAJASTHAN	Akal	1x25 MVar	1x25 MVAR Reactor at Akal has been commissioned on dated 25th July' 2022.

xii	RAJASTHAN	Bikaner	1x25 MVar	Main bus shutdown is required for commissioning of 1x25 MVAR reactor at Bikaner, same is expected upto March' 2023.
xiii	RAJASTHAN	Suratgarh	1x25 MVar	1x25 MVAR Reactor at Suratgarh has been commissioned on dated 25th November' 2022.
xiv	RAJASTHAN	Barmer & others	13x25 MVar	Agreement signed on dt. 22.06.2020. Grant of Ist Instalment received on dt.19.02.21 &work order placed on dt. 7.04.2022 to M/s Kanohar Electricals Ltd. Schedule time is 18 months.
xv	RAJASTHAN	Jodhpur	1x125 MVar	Agreement signed on dt. 22.06.2020. Grant of Ist Instalment received on dt.19.02.21 &work order placed on dt. 7.04.2022 to M/s Kanohar Electricals Ltd. Schedule time is 18 months.

1. Down Stream network by State utilities from ISTS Station:

Sl. No.	Substation	Downstream network bays	Status of bays	Planned 220 kV system and Implementation status	Revised Target	Remarks
1	400/220kV, 3x315 MVA Samba	Commissioned: 8 Total: 8	Utilized: 6 Unutilized: 2	• Network to be planned for 2 bays.	Jun'23	02 No. of bays shall be utilized for LILO-II of 220kV Hiranagar Bishnah Transmission Line, the work of which is under progress and shall be completed by end of Jun'2023. Updated in 207th OCC by JKPTCL.
2	400/220kV, 2x315 MVA New Wanpoh	Commissioned: 6 Total: 6	Utilized: 2 Unutilized: 4	• 220 kV New Wanpoh - Alusteng D/c Line	End of 2023	02 No. of bays are to be utilized for connecting 220kV New Wanpoh-Alusteng D/c Line. The work is in progress and expected to be commission by the end of 2023. Updated in 204th OCC by JKPTCL.
				• 220 kV New Wanpoh - Mattan D/c Line	End of 2024	02 No. of bays are to be utilized for connecting 220kV New Wanpoh-Mattan D/c Line. The funding source for the project is being identified and the project is expected to be completed by ending 2024. Updated in 204th OCC by JKPTCL.
3	400/220kV, 2x315 MVA Amargarh	Commissioned: 6 Total: 6	Utilized: 4 Unutilized: 2	• 220kV D/C line from 400/220kV Kunzar - 220/33kV Sheeri	End of 2024	02 No. of bays are proposed to be utilized for connecting 220/132 kV GSS Loolipora. The funding source for the project is being identified and the project is expected to be completed by ending 2024. Updated in 204th OCC by JKPTCL.
4	400/220kV, 2x500 MVA Kurukshetra (GIS)	Commissioned: 8 Total: 8	Utilized: 6 Unutilized: 2	• 220kV Bhadson (Kurukshetra) – Ramana Ramani D/c line	Jul'24	Updated in 205th OCC by HVPNL
5	400/220 kV, 2x315 MVA Dehradun	Commissioned: 6 Total: 6	Utilized: 2 Unutilized: 4	• Network to be planned for 4 bays	-	PTCUL to update the status.
6	Shahjahanpur, 2x315 MVA 400/220 kV	Commissioned: 6 Approved/Under Implementation:1 Total: 7	Utilized: 5 Unutilized: 1 (1 bays to be utilized shortly) Approved/Under Implementation:1	• 220 kV D/C Shahajahanpur (PG) - Gola line	15.07.2023	Due to ROW issue work was delayd.Updated in 208th OCC by UPPTCL
				• LILO of Sitapur – Shahjahanpur 220 kV SC line at Shahjahanpur (PG)	Commissioned	Energization date: 25.02.2022 updated by UPPTCL in 196th OCC
7	Hamirpur 400/220 kV Sub-station	Commissioned: 8 Total: 8	Utilized: 4 Unutilized: 4 (2 bays to be utilized shortly)	• 220 kV Hamirpur-Dehan D/c line	Commissioned	Commisioned date: 09.06.2022. Updated in 198th OCC by HPPTCL
				• Network to be planned for 4 bays	-	HPPTCL to update the status.
8	Sikar 400/220kV, 1x 315 MVA S/s	Commissioned: 8 Total: 8	Utilized: 6 Unutilized: 2	• LILO of 220 kV Sikar (220 kV GSS)-Dhod S/c line at Sikar (PG)	Commissioned	LILO of 220 kV S/C Sikar-Dhod line at 400 kV GSS PGCIL, Sikar has been charged on dt. 31.03.2022
				• Network to be planned for 2 bays.	-	Against the 3rd ICT at 400 kV GSS Sikar, only 2 bays were constructed and same has been utilized by RVPN by constructing LILO of 220 kV S/C Sikar – Dhod line as updated by RVPNL in 195th OCC
9	Bhiwani 400/220kV S/s	Commissioned: 6 Total: 6	Utilized: 2 Unutilized: 4	• 220 kV D/C line Bhiwani (PG) – Bhiwani (HVPNL) line	Commissioned	Updated in 202nd OCC by HVPNL
				• 220 kV Bhiwani (PG) - Isherwal (HVPNL) D/c line.	Dec'23	Issue related to ROW as intimated in 208th OCC by HVPNL.
				• 220 kV Bhiwani (PG) - Dadhibana (HVPNL) D/c line.	Apr'24	Issue related to ROW as intimated in 192nd OCC by HVPNL.
10	Jind 400/220kV S/s	Commissioned: 4 Approved:4 Total: 8	Utilized: 4 Unutilized: 0	• LILO of both circuits of 220 kV Jind HVPNL to PTPS D/C line at 400 kV substation PGCIL Khatkar (Jind) with 0.5 sq inch ACSR conductor	May'24	Tender is under process Updated in 205th OCC by HVPNL.
11	400/220kV Tughlakabad	Commissioned: 6 Under Implementation: 4	Utilized: 6 Unutilized: 0	• RK Puram – Tughlakabad (UG Cable) 220kV D/c line – March 2023.	-	DTL to update the status.

Sl. No.	Substation	Downstream network bays	Status of bays	Planned 220 kV system and Implementation status	Revised Target	Remarks
	GIS	Total: 10	Under Implementation:4	• Masjid Mor – Tughlakabad 220kV D/c line.	-	DTL to update the status.
12	400/220kV Kala Amb GIS (TBCB)	Commissioned: 6	Utilized: 0	• HPPTCL has planned one no. of 220kV D/c line from Kala Amb 400/220kV S/s to 220/132kV Kala Amb S/s	Sep'23	Updated in 208th OCC by HPPTCL
		Total: 6	Unutilized: 6	• Network to be planned for 2 bays	-	HPPTCL to update the status.
13	400/220kV Kadarpur Sub-station	Commissioned: 8	Utilized: 0	• LILO of both circuits of 220 KV Pali - Sector 56 D/C line at Kadarpur along with augmentation of existing conductor from 220 KV Sector-56 to LILO point with 0.4 sq inch AL-59 conductor.	Dec'23	Forest approval is pending for 220 KV Pali - Sector 56 D/C line. Updated in 205th OCC by HVPNL
		Total: 8	Unutilized: 8	• LILO of both circuits of 220KV Sector 65 - Pali D/C line at Kadarpur along with augmentation of balance 0.4 sq. inch ACSR conductor of 220 kV Kadarpur - Sector 65 D/C line with 0.4sq inch AL-59 conductor	Dec'23	Updated in 205th OCC by HVPNL
14	400/220kV Sohna Road Sub-station	Commissioned: 8	Utilized: 2	• LILO of both circuits of 220kV D/c Sohna-Rangla Rajpur at Roj Ka Meo	Jan'24	Updated in 208th OCC by HVPNL
		Total: 8	Unutilized: 4	• LILO of both circuits of 220kV D/c Badshahpur-Sec77 line at 400kV Sohna Road	-	The matter is subjudice in Hon'ble Punjab & Haryana High court, Chandigarh Updated in 205th OCC by HVPNL. Status:- Earlier 02 nos 220 kV line bays were to be utilized for the 220 kV GIS S/Stn. Sec-77, Gurugram but due to denotification of land of the 220 kV GIS S/Stn. Sec-77 the said substation is now going to be dismantled and a new substation is proposed at Sec-75A, Gurugram. Now, these 02 no. 220 kV line bays may be utilized at 220 kV GIS S/Stn Sec-75A, Gurugram.
15	400/220kV Prithla Sub-station	Commissioned: 8	Utilized: 4	• Prithla - Harfali 220kV D/c line with LILO of one ckt at Meerpur Kurali	31.03.2024	Updated in 205th OCC by HVPNL
		Total: 8	Unutilized: 4	• LILO of both ckt of 220kV D/c Ranga Rajpur – Palwal line	Commissioned	Commisioned date: 31.12.2021. Updated in 198th OCC by HVPNL
			Under Implementation:2	• 220kV D/C for Sector78, Faridabad	31.03.2024	Issue related to ROW and Pending crossing approval from Northern Railways and DFCCIL. as intimated in 205th OCC by HVPNL.
				• Prithla - Sector 89 Faridabad 220kV D/c line	31.03.2024	Updated in 205th OCC by HVPNL
16	400/220kV Sonapat Sub-station	Commissioned: 6	Utilized: 2	• LILO of both circuits of 220kV Samalkha - Mohana line at Sonapat	05.10.2023	Updated in 205th OCC by HVPNL
		Under Implementation:2 Total: 8	Unutilized: 4 Under	• Sonapat - HSIISC Rai 220kV D/c line	-	Updated in 205th OCC by HVPNL. Status: Due to non-performance of work of 220KV GIS Rai S/Stn, the Contract has been terminated & blacklisted by O/o XEN/WB O/o CE/PD&C, HVPNL, Panchkula vide Ch-100/HDP-2418/REC-254/Xen(WB) Dated 24.02.2023. Now pending work will be caried out by HVPNL/ Departmentely

Sl. No.	Substation	Downstream network bays	Status of bays	Planned 220 kV system and Implementation status	Revised Target	Remarks
			Implementation:2	• Sonapat - Kharkhoda Pocket A 220kV D/c line	31.07.2024	Updated in 205th OCC by HVPNL. Status: The Possession of land for construction of 220KV S/Stn. Pocket-A i.e 6.33 Acres and for Pocket-B is 5.55 Acres has been taken over by HVPNL. Work order yet to be issued by O/o CE/PD&C, Panchkula for construction of 2 no. 220KV GIS S/Stn Pocket-A & Pocket-B.
17	400/220kV Neemrana Sub-station	Commissioned: 6 Total: 6	Utilized: 4 Unutilized: 2	• LILO of Bhiwadi - Neemrana 220kV S/c line at Neemrana (PG)	-	Work order is finalized as updated in 201st OCC by RVPNL. 5 months from layout finalization.
18	400/220kV Kotputli Sub-station	Commissioned: 6 Total: 6	Utilized: 4 Unutilized: 2	• Kotputli - Pathreda 220kV D/c line	-	Bid documents under approval as updated in 195th OCC by RVPNL.
19	400/220kV Jalandhar Sub-station	Commissioned: 10 Total: 10	Utilized: 8 Unutilized: 2	• Network to be planned for 2 bays	May'24	LILO of 220 kV BBMB Jalandhar - Butari line at 400 kV PGCIL Jalandhar being planned. Work expected to be completed by May 2024. Updated in 198th OCC by PSTCL.
20	400/220kV Roorkee Sub-station	Commissioned: 6 Total: 6	Utilized: 4 Unutilized: 2	• Roorkee (PG)-Pirankaliyar 220kV D/c line	Commissioned	Roorkee (PG)-Pirankaliyar 220kV D/c line commissioned in 2020 as intimated by PTCUL in 197th OCC
21	400/220kV Lucknow Sub-station	Commissioned: 8 Total: 8	Utilized: 4 Unutilized: 4	• Network to be planned for 2 bays	10.07.2023	• Lucknow -Kanduni, 220 kV D/C line expected energization date Jul'23 updated by UPPTCL in 208th OCC due to sub-station commissioning delay • No planning for 2 no. of bays updated by UPPTCL in 196th OCC. The same has been communicated to Powergrid.
22	400/220kV Gorakhpur Sub-station	Commissioned: 6 Total: 6	Utilized: 4 Unutilized: 2	• Network to be planned for 2 bays	15.07.2023	• Gorakhpur(PG)- Maharajganj, 220 kV D/C line expected energization date is 15.07.2023 updated by UPPTCL in 208th OCC
23	400/220kV Fatehpur Sub-station	Commissioned: 8 Under Implementation:2 Total: 10	Utilized: 6 Unutilized: 2 Under Implementation:2	• Network to be planned for 2 bays	-	• UPPTCL intimated that 02 no. of bays under finalization stage. In 201st OCC, UPPTCL intimated that it is finalized that Khaga s/s will be connected (tentative time 1.5 years). • No planning for 2 no. of bays updated by UPPTCL in 196th OCC. The same has been communicated to Powergrid.
24	400/220kV Abdullapur Sub-station	Commissioned: 10 Under Implementation:2 Total: 12	Utilized: 10 Unutilized: 0 Under Implementation:2	• Abdullapur – Rajokheri 220kV D/c line	Jul'23	SCDA System work pending at 220 KV S/stn. Rajokheri Updated in 205th OCC by HVPNL
25	400/220kV Pachkula Sub-station	Commissioned: 8 Under tender:2 Total: 10 Out of these 10 nos. 220kV Line Bays, 2 bays would be used by the lines being constructed by POWERGRID (Chandigarh-2) and balance 8 nos. bays would be used by HVPNL	Utilized: 2 Unutilized: 4 Under Implementation:2	• Panchkula – Pinjore 220kV D/c line	Sep'23	Updated in 205th OCC by HVPNL
				• Panchkula – Sector-32 220kV D/c line	Sep'23	Updated in 205th OCC by HVPNL
				• Panchkula – Raiwali 220kV D/c line	Commissioned	Updated in 194th OCC by HVPNL
				• Panchkula – Sadhaura 220kV D/c line: Sep'23	Jul'24	Updated in 205th OCC by HVPNL
		Commissioned:7	Utilized: 6	• Amritsar – Patti 220kV S/c line	15.07.2023	Route survey/tender under process. Work expected to be completed by 15th July 2023. Updated in 208th OCC by PSTCL.

Sl. No.	Substation	Downstream network bays	Status of bays	Planned 220 kV system and Implementation status	Revised Target	Remarks
26	400/220kV Amritsar S/s	Approved in 50th NRPC- 1 no. Total: 8	Unutilized: 1 Approved in 50th NRPC- 1 no.	• Amritsar – Rashiana 220kV S/c line (2 bays shall be required for above lines. However, 1 unutilized bay shall be used for Patti and requirement of one additional bay approved for Rashiana by NRPC)	15.08.2023	Route survey/tender under process. Work expected to be completed by 15th August 2023. Updated in 208th OCC by PSTCL.
27	400/220kV Bagpat S/s	Commissioned: 8 Total: 8	Utilized:6 Unutilized: 2	• Bagpat - Modipuram 220kV D/c line	Commissioned	Updated in 201st OCC by UPPTCL
28	400/220kV Bahadurgarh S/s	Commissioned: 4 Total: 4	Utilized:2 Unutilized: 2	• LILO of 220 kV Nunamajra-Daultabad S/c line at 400 kV Bahadurgarh PGCIL	31.03.2024	Updated in 205th OCC by HVPNL. Status: Tentative route stands submitted by TS wing and accordingly BOQ has been submitted by design wing to contracts wing for award of work.
				• Bahadurgarh - METL 220kV D/c line (Deposit work of M/s METL)	31.03.2024	Updated in 205th OCC by HVPNL. Status: Tentative route stands submitted by TS wing and accordingly BOQ has been submitted by design wing to contracts wing for award of work.
				• Bahadurgarh - Kharkhoda Pocket B 220kV D/c line	31.07.2024	
29	400/220kV Jaipur (South) S/s	Commissioned: 4 Total: 4	Utilized:2 Unutilized: 2	• Network to be planned for 2 bays.	-	LILO case of 220 kV Dausa – Sawai Madhopur line at 400 kV GSS Jaipur South (PG) is under WTD approval as updated by RVPNL in 195th OCC
30	400/220kV Sohawal S/s	Commissioned: 8 Total: 8	Utilized: 8	• Sohawal - Barabanki 220kV D/c line	Commissioned	Energization date: 14.04.2018 updated by UPPTCL in 196th OCC
				• Sohawal - New Tanda 220kV D/c line	Commissioned	Energization date: 28.05.2019 updated by UPPTCL in 196th OCC
				• Network to be planned for 2 bays	Commissioned	• Sohawal - Gonda 220kV S/c line (Energization date: 27.04.2020) updated by UPPTCL in 196th OCC • Sohawal - Bahraich 220kV S/c line (Energization date: 15.02.2021) updated by UPPTCL in 196th OCC
31	400/220kV, Kankroli	Commissioned: 6 Total: 6	Utilized: 4 Unutilized: 2	• Network to be planned for 2 bays	-	RVPNL to update the status
32	400/220kV, Manesar	Commissioned: 8 Total: 8	Utilized: 4 Unutilized: 4	• Network to be planned for 4 bays	-	Status:- 2nos bays are being utilised for 220 kV D/C Panchgaon (PGCIL)-Panchgaon Ckt-I & 220 kV D/C Panchgaon (PGCIL)-Panchgaon Ckt-II, charged on dated 05.09.2022 & 20.10.2022 respectively. The 2nos bays may be utilised by HVPNL in future.
33	400/220kV, Saharanpur	Commissioned: 6 Under Implementation:2 Total: 8	Utilized: 6 Unutilized: 0 Under Implementation:2	• Network to be planned for 2 bays	Commissioned	Saharanpur(PG)-Devband D/c line (Energization date: 20.04.2023) updated by UPPTCL in 207th OCC
34	400/220kV, Wagoora	Commissioned: 10 Total: 10	Utilized: 6 Unutilized: 4	• Network to be planned for 4 bays	-	PDD, J&K to update the status.
35	400/220kV, Ludhiana	Commissioned: 9 Total: 9	Utilized: 8 Unutilized: 1	• Network to be planned for 1 bay	30.06.2023	Direct circuit from 220 kV Lalton Kalan to Dhandari Kalan to be diverted to 400 kV PGCIL Ludhiana. Work expected to be completed by 30.06.2023.Updated in 208th OCC by PSTCL.

Sl. No.	Substation	Downstream network bays	Status of bays	Planned 220 kV system and Implementation status	Revised Target	Remarks
36	400/220kV, Chamba (Chamera Pool)	Commissioned: 3 Under tender:1 Total: 4	Utilized:3 Unutilized: 0 Under tender:1	• Stringing of 2nd ckt of Chamera Pool – Karian 220kV D/c line	-	Stringing of 2nd Circuit of Chamera Pool-Karian Transmission line has been completed & terminal bay at 400/220 kV chamera pooling substation (PGCIL) is not ready.Updated in 198th OCC by HPPTCL
37	400/220kV, Mainpuri	Commissioned: 6 Under Implementation:2 Total: 8	Utilized: 6 Unutilized: 0 Under Implementation:2	• Network to be planned for 2 bays	-	• 02 no. of bays under finalization stage updated by UPPTCL in 196th OCC. Mainpuri S/s planned. Land is not finalized, therefore timeline not available as intimated by UPPTCL in 201st OCC.
38	400/220kV, Patiala	Commissioned: 8 Total: 8	Utilized: 6 Unutilized: 2	• Network to be planned for 2 bays	May'24	2 Nos. bays for 400 kV PGCIL Patiala - 220 kV Bhadson (D/C) line being planned. Work expected to be completed by May 2024. Updated in 198th OCC by PSTCL.

FGD Status

Updated status of FGD related data submission

NTPC (27.02.2023)

MEJA Stage-I

RIHAND STPS

SINGRAULI STPS

TANDA Stage-I

TANDA Stage-II

UNCHAHAR TPS

UPRVUNL (17.05.2023)

ANPARA TPS

HARDUAGANJ TPS

OBRA TPS

PARICHHA TPS

PSPCL (16.02.2023)

GGSSSTP, Ropar

GH TPS (LEH.MOH.)

RRVUNL (09.06.2023)

CHHABRA SCPP

CHHABRA TPP

KALISINDH TPS

KOTA TPS

SURATGARH SCTPS

SURATGARH TPS

Updated status of FGD related data submission

**Lalitpur Power Gen. Co. Ltd.
(17.10.2022)**

Lalitpur TPS

**Lanco Anpara Power Ltd.
(18.06.2022)**

ANPARA-C TPS

HGPCL (14.09.2022)

PANIPAT TPS

RAJIV GANDHI TPS

YAMUNA NAGAR TPS

Adani Power Ltd. (18.02.2022)

KAWAI TPS

**Rosa Power Supply Company
(18.06.2022)**

Rosa TPP Phase-I

**Prayagraj Power Generation
Company Ltd. (17.10.2022)**

Prayagraj TPP

APCPL (25.02.2022)

INDIRA GANDHI STPP

Pending submissions

GVK Power Ltd.

GOINDWAL SAHIB

NTPC

DADRI (NCTPP)

Talwandi Sabo Power Ltd.

TALWANDI SABO TPP

L&T Power Development Ltd.

Nabha TPP (Rajpura TPP)

Target Dates for FGD Commissioning (Utility-wise)

Adani Power Ltd.	KAWAI TPS U#1 (Target: 31-12-2024), KAWAI TPS U#2 (Target: 31-12-2024)
APCPL	INDIRA GANDHI STPP U#1 (Target: 31-01-2022), INDIRA GANDHI STPP U#2 (Target: 30-09-2023), INDIRA GANDHI STPP U#3 (Target: 30-06-2023)
GVK Power Ltd.	GOINDWAL SAHIB U#1 (Target: 30-04-2020), GOINDWAL SAHIB U#2 (Target: 29-02-2020)
HGPCL	PANIPAT TPS U#6 (Target: 31-12-2022), PANIPAT TPS U#7 (Target: 31-12-2022), PANIPAT TPS U#8 (Target: 31-12-2022), RAJIV GANDHI TPS U#1 (Target: 31-12-2024), RAJIV GANDHI TPS U#2 (Target: 31-12-2024), YAMUNA NAGAR TPS U#1 (Target: 31-12-2024), YAMUNA NAGAR TPS U#2 (Target: 31-12-2024)

NTPC

DADRI (NCTPP) U#1 (Target: 31-12-2020), DADRI (NCTPP) U#2 (Target: 31-10-2020), DADRI (NCTPP) U#3 (Target: 31-08-2020), DADRI (NCTPP) U#4 (Target: 30-06-2020), DADRI (NCTPP) U#5 (Target: 30-06-2022), DADRI (NCTPP) U#6 (Target: 31-03-2023), RIHAND STPS U#1 (Target: 31-10-2025), RIHAND STPS U#2 (Target: 30-06-2026), RIHAND STPS U#3 (Target: 31-12-2024), RIHAND STPS U#4 (Target: 31-03-2025), RIHAND STPS U#5 (Target: 30-06-2025), RIHAND STPS U#6 (Target: 31-10-2025), SINGRAULI STPS U#1 (Target: 31-12-2024), SINGRAULI STPS U#2 (Target: 31-12-2024), SINGRAULI STPS U#3 (Target: 31-12-2024), SINGRAULI STPS U#4 (Target: 31-12-2024), SINGRAULI STPS U#5 (Target: 31-03-2025), SINGRAULI STPS U#6 (Target: 31-06-2024), SINGRAULI STPS U#7 (Target: 31-03-2024), UNCHAHAR TPS U#1 (Target: 31-12-2023), UNCHAHAR TPS U#2 (Target: 31-12-2023), UNCHAHAR TPS U#3 (Target: 30-09-2023), UNCHAHAR TPS U#4 (Target: 30-09-2023), UNCHAHAR TPS U#5 (Target: 30-09-2023), UNCHAHAR TPS U#6 (Target: 31-08-2022), MEJA Stage-I U#1 (Target: 31-10-2023), MEJA Stage-I U#2 (Target: 30-06-2023), TANDA Stage-I U#3 (Target:), TANDA Stage-I U#4 (Target:), TANDA Stage-II U#3 (Target: 31-03-2023), TANDA Stage-II U#4 (Target: 30-09-2023)

L&T Power Development Ltd (Nabha)	Nabha TPP (Rajpura TPP) U#1 (Target: 30-04-2021), Nabha TPP (Rajpura TPP) U#2 (Target: 28-02-2021)
Lalitpur Power Gen. Company Ltd.	LALITPUR TPS U#1 (Target: 31-12-2026), LALITPUR TPS U#2 (Target: 30-09-2026), LALITPUR TPS U#3 (Target: 30-06-2026)
Lanco Anpara Power Ltd.	ANPARA C TPS U#1 (Target: 31-12-2023), ANPARA C TPS U#2 (Target: 31-12-2023)
Prayagraj Power Generation Company Ltd.	PRAYAGRAJ TPP U#1 (Target: 31-12-2024), PRAYAGRAJ TPP U#2 (Target: 31-12-2024), PRAYAGRAJ TPP U#3 (Target: 31-12-2024)
PSPCL	GH TPS (LEH.MOH.) U#1 (Target: 31-12-2026), GH TPS (LEH.MOH.) U#2 (Target: 31-12-2026), GH TPS (LEH.MOH.) U#3 (Target: 31-12-2026), GH TPS (LEH.MOH.) U#4 (Target: 31-12-2026), GGSSTP, Ropar U#3 (Target: 31-12-2026), GGSSTP, Ropar U#4 (Target: 31-12-2026), GGSSTP, Ropar U#5 (Target: 31-12-2026), GGSSTP, Ropar U#6 (Target: 30-12-2026)

Rosa Power Supply Company	ROSA TPP Ph-I U#1 (Target: 31-12-2026), ROSA TPP Ph-I U#2 (Target: 31-12-2026), ROSA TPP Ph-I U#3 (Target: 31-12-2026), ROSA TPP Ph-I U#4 (Target: 31-12-2026)
RRVUNL	KOTA TPS U#5 (Target: 31-08-2024), KOTA TPS U#6 (Target: 31-08-2024), KOTA TPS U#7 (Target: 31-08-2024), SURATGARH TPS U#1 (Target: 31-12-2026), SURATGARH TPS U#2 (Target: 31-12-2026), SURATGARH TPS U#3 (Target: 31-12-2026), SURATGARH TPS U#4 (Target: 31-12-2026), SURATGARH TPS U#5 (Target: 31-12-2026), SURATGARH TPS U#6 (Target: 31-12-2026), SURATGARH SCTPS U#7 (Target: 28-02-2025), SURATGARH SCTPS U#8 (Target: 28-02-2025), CHHABRA TPP U#1 (Target: 31-12-2026), CHHABRA TPP U#2 (Target: 31-12-2026), CHHABRA TPP U#3 (Target: 31-12-2026), CHHABRA TPP U#4 (Target: 31-12-2026), CHHABRA SCPP U#5 (Target: 28-02-2025), CHHABRA SCPP U#6 (Target: 28-02-2025), KALISINDH TPS U#1 (Target: 28-02-2025), KALISINDH TPS U#2 (Target: 28-02-2025)
Talwandi Sabo Power Ltd.	TALWANDI SABO TPP U#1 (Target: 28-02-2021), TALWANDI SABO TPP U#2 (Target: 31-12-2020), TALWANDI SABO TPP U#3 (Target: 31-10-2020)
UPRVUNL	ANPARA TPS U#1 (Target: 31-12-2023), ANPARA TPS U#2 (Target: 31-12-2023), ANPARA TPS U#3 (Target: 31-12-2023), ANPARA TPS U#4 (Target: 31-12-2023), ANPARA TPS U#5 (Target: 31-12-2023), ANPARA TPS U#6 (Target: 31-12-2023), ANPARA TPS U#7 (Target: 31-12-2023), HARDUAGANJ TPS U#8 (Target: 31-12-2024), HARDUAGANJ TPS U#9 (Target: 31-12-2024), OBRA TPS U#9 (Target: 31-12-2024), OBRA TPS U#10 (Target: 31-12-2024), OBRA TPS U#11 (Target: 31-12-2024), OBRA TPS U#12 (Target: 31-12-2024), OBRA TPS U#13 (Target: 31-12-2024), PARICHHA TPS U#3 (Target: 30-04-2022), PARICHHA TPS U#4 (Target: 31-12-2024), PARICHHA TPS U#5 (Target: 31-12-2024), PARICHHA TPS U#6 (Target: 31-12-2024)



RAJASTHAN RAJYA VIDYUT UTPADAN NIGAM LIMITED
(A Government of Rajasthan undertaking)
 Corporate Identity Number (CIN)-U40102RJ2000SGC016484
 Regd. Office & H.O.: Vidyut Bhawan, Janpath, Jyoti Nagar, Jaipur-302005
Office of the Chief Engineer (PPC& PTD)



No.RRVUNL/CE(PPC&PTD)/XEN(Tech.-Cell/AEN(Tech.-Cell)/F.-09/D.-593

Date- 20/6/23

**The Member Secretary (EAC),
 Chief Engineer (LD),
 RRVPNL,
 Heerapura, Jaipur.**

Sub.:- Regarding revised Anticipated/Actual Energy Availability (Ex-Bus) (in LU/Day & MW) and Annual Maintenance Schedule of RRVUNL Power Stations for FY_2023-24 as on 20.06.2023.

Ref.:- 1. No.RRVUNL/CE(PPC&PTD)/XEN(Tech.-Cell/AEN(Tech.-Cell)/F.-09/D.-2962/Dtd.-31.03.2023.
 2. No. NRPC/Operation/106/01/2023/6024-6055/Dtd.-15.06.2023 regarding Agenda of 208th OCC Meeting held on 20.06.2023.

With references to above cited subject, as per directions from 208th OCC, NRPC Meeting held on 20.06.2023 to defer the Planned Outages falling in the last week of August-23 & month of September-23 (as per Agenda Point No.-8), please find enclosed herewith the revised Anticipated/Actual Energy Availability (Ex-Bus) (in LU/Day & MW) and Annual Maintenance Schedule of RRVUNL Power Stations for FY_2023-24 as on 20.06.2023 as per enclosed Annexure-I & II for further needful.

Encl.:- As above.

 (A K Agrawal)

Addl. Chief Engineer (PPC&PTD)

Copy submitted / forwarded to the following for information and n/a please:

1. The Managing Director, RUVNL, Jaipur.
2. The Director (Project/Technical), RRVUNL, Jaipur.
3. The Director (Technical/Operations), RRVPNL, Jaipur.
4. The Chief Engineer (RUVNL), Jaipur.
5. The TA to Hon'ble CMD, RRVUNL, Jaipur.
6. The Superintending Engineer (Operation), NRPC, GOI, New Delhi.
7. MF/OC.

 (C.P.K. SHARMA), XEN



Addl. Chief Engineer (PPC&PTD)

Room No.301, 3rd Floor, Rajasthali Mall, MI Road, Ajmeri Gate, Jaipur-302001.

Phone No. : 0141-4018794, Fax No. : 0141-2744521

Email : ce.ppmcit@rrvun.com, montg.rvun@gmail.com, website : www.energy.rajasthan.gov.in/rrvunl

Rajasthan Rajya Vidyut Utpadan Nigam Ltd.
Daily Anticipated/Actual Energy Availability (Ex-Bus) of RRVUNL Power Stations for FY 2023-24

as on Dt.-20.06.23

Name of Power Station	Capacity (MW)		Daily Availability (EX-Bus)	Apr-23		May-23		Jun-23	Jul-23	Aug-23	Sep-23	Oct-23	Nov-23	Dec-23	Jan-24	Feb-24	Mar-24	
	Installed	Ex-Bus (RERC Nor.)		Anticipated	Actual	Anticipated	Actual											
SSTPS, Suratgarh	1500	1353	MW	970	962	1015	1159	1015	900	900	1015	1015	1015	1015	1015	1015	1015	1015
			LU	232.72	230.78	243.54	278.24	243.54	216.04	216.04	243.54	243.54	243.54	243.54	243.54	243.54	243.54	243.54
SSCTPP, Suratgarh	1320	1250.7	MW	938	776	938	924	938	938	938	844	711	704	711	938	938	938	938
			LU	225.13	186.28	225.13	221.69	225.13	225.13	225.13	202.61	170.66	168.84	170.66	225.13	225.13	225.13	225.13
KSTPS, Kota	1240	1120.34	MW	698	913	817	981	766	777	776	840	751	840	840	744	745	840	840
			LU	167.51	219.00	196.15	235.55	183.77	186.45	186.24	201.66	180.18	201.66	201.66	178.53	178.70	201.66	201.66
KaSTPP, Kalisindh	1200	1137	MW	853	845	853	816	853	468	660	853	853	853	853	853	853	853	853
			LU	204.66	202.83	204.66	195.91	204.66	112.23	158.45	204.66	204.66	204.66	204.66	204.66	204.66	204.66	204.66
CTPP, Chhabra	1000	902	MW	592	611	633	705	507	551	677	677	507	626	677	677	677	677	677
			LU	142.07	146.66	151.89	169.28	121.77	132.24	162.36	162.36	121.77	150.18	162.36	162.36	162.36	162.36	162.36
CSCTPP, Chhabra	1320	1250.7	MW	938	855	938	875	860	530	666	938	938	938	938	938	938	938	938
			LU	225.13	205.20	225.13	209.89	206.37	127.09	159.77	225.13	225.13	225.13	225.13	225.13	225.13	225.13	225.13
RGTPP, Ramgarh	273.50	262.926	MW	145	133	145	138	145	145	184	184	184	184	184	148	75	128	128
			LU	34.82	32.02	34.82	33.10	34.82	34.82	44.17	44.17	44.17	44.17	44.17	35.60	18.04	30.69	30.69
MAHL, Hydrel, Banswara	140	138.6	MW	8	0	0	0	0	0	0	48	0	26	37	37	34	27	27
			LU	1.98	0.00	0.00	0.00	0.00	0.00	0.00	11.55	0.00	6.27	8.94	8.94	8.19	6.39	6.39
TOTAL	7993.5	7415.266	MW	5142	5095	5339	5599	5084	4308	4801	5399	4959	5185	5255	5349	5274	5415	5415
			LU	1234	1223	1281	1344	1220	1034	1152	1296	1190	1244	1261	1284	1266	1300	1300

*Actual Energy Availability (LU/Day) is based on implemented DC as verified by SLDC, RRVPNL.

Note:- 1. For RGTPP-GT-2, The Anticipated Energy Availability is considered zero from 01.04.2023 to 31.07.2023 due to Fire incidence occurred w.e.f. 10.12.2021.

Note:- Assumptions taken for calculation of Anticipated Energy Availability (Ex-Bus) of RRVUNL Power Stations:-

- 1) For SSTPS, the Availability has been taken as 75%.
 - 2) For SSCTPP, the Availability has been taken as 75%.
 - 3) For KSTPS, the Availability has been taken as 75%.
 - 4) For KaSTPP, the Availability has been taken as 75%.
 - 5) For CTPP, the Availability has been taken as 75%.
 - 6) For CSCTPP, the Availability has been taken as 75%.
 - 7) For RGTPP, the Availability has been taken as 70%.
- (Considering Gas availability is 1.7 MMSCMD/Day i.e. for 100% PLF for Stg.-I&II & 85% PLF for Stg.-III. In case Gas availability is less then Energy availability may be lower).
- 8) For DCCPP, in addition to the above Daily Availability, 256.34 MW/61.52 LU/80% (Ex-Bus per day) will also be available from DCCPP (330 MW) subject to permit by SLDC/RUVN to run the units on Spot Gas.

(Handwritten Signature)
C.P.K. SHARMA
 XED

Rajasthan Rajya Vidyut Utpadan Nigam Ltd.
Anticipated/Actual Annual Maintenance Schedule of RRVUNL Power Stations for FY 2023-24

as on Dt.-20.06.23

S. No.	Unit No.	Capacity (MW)	Annual Maintenance Schedule			Reasons
			From	To	Duration (Days)	
SSTPS, Suratgarh						
1	U#1	250	NR			-
2	U#2	250	NR			-
3	U#3	250	NR			-
4	U#4	250	NR			-
5	U#6	250	07.07.23	27.07.23	21	Boiler Overhauling
6	U#5	250	01.08.23	21.08.23	21	Boiler Overhauling
SSCTPP, Suratgarh						
7	U#8	660	25.09.23	15.10.23	21	Boiler Overhauling
8	U#7	660	16.11.23	15.12.23	30	Boiler Overhauling
KSTPS, Kota						
9	U#5	210	NR			-
10	U#1	110	05.06.23	26.06.23	22	<u>Under Boiler Overhauling</u>
11	U#2	110	23.06.23	13.07.23	21	Boiler Overhauling
12	U#4	210	25.07.23	14.08.23	21	Boiler Overhauling
13	U#7	195	01.10.23	21.10.23	21	Boiler Overhauling
14	U#3	210	01.01.24	21.01.24	21	Boiler Overhauling
15	U#6	195	01.02.24	21.02.24	21	Boiler Overhauling
KaSTPP, Kalisindh						
16	U#1	600	01.07.23	21.07.23	21	Boiler Overhauling
17	U#2	600	25.07.23	14.08.23	21	Boiler Overhauling
CTPP, Chhabra						
18	U#1	250	NR			-
19	U#2	250	NR			-
20	U#3	250	24.05.23	23.07.23	61	<u>Under Capital Overhauling</u>
21	U#4	250	01.10.23	09.11.23	40	Capital Overhauling
CSCTPP, Chhabra						
22	U#6	660	26.06.23	20.07.23	25	Boiler Overhauling
23	U#5	660	25.07.23	18.08.23	25	Boiler Overhauling
DCCPP, Dholpur						
24	GT#1	110	NR			-
25	GT#2	110				
26	STG	110				
RGTPP, Ramgarh						
27	GT-2	37.5	NR			-
28	STG-I	37.5	NR			-
29	GT-I	35.5	01.01.24	30.01.24	30	Replacement of Diffuser and Exhaust Planum
30	GT-3	110	01.02.24	16.03.24	45	Major Inspection & Planned Maintenance
31	STG-II	50	01.02.24	16.03.24	45	Planned Maintenance

Signature
 (P.K. Sharma), XED

I/28436/2023

Annexure-A.III



भारत सरकार

Government of India

विद्युत मंत्रालय

Ministry of Power

केन्द्रीय विद्युत प्राधिकरण

Central Electricity Authority

विद्युत प्रणाली योजना एवं मूल्यांकन-I प्रभाग

Power System Planning & Appraisal-I Division

सेवा में / To,

1. COO, CTUIL, Saudamini, Plot No. 2, Sector-29, Gurugram-122001
2. Chief Engineer, PDD Ladakh, UT of Ladakh
3. Chief Engineer (Transmission, Kashmir), JKPTCL, PDD Complex, Bemina, Srinagar, UT of J&K
4. ED (NR-II), POWERGRID, OB-26, GRID Bhawan, Rail Head Complex, Near Bahu Plaza, Jammu (UT of J&K) - 180012

विषय/Subject: Minutes of the meeting held for deliberation on the issue related to the reliability of power supply for UT of Ladakh - reg.

महोदय / Sir,

Please find enclosed the minutes of the meeting under the chairmanship of Member (Power System) for deliberation on the issue related to the reliability of power supply for UT of Ladakh held in CEA on 06.06.2023.

भवदीय / Yours faithfully,

(नितिन देसवाल / Nitin Deswal)

उप-निदेशक / Deputy Director

Copy to (for information):

1. SA to Member (PS), CEA
2. Member Secretary (NRPC), 18-A, Qutab Institutional Area, Shaheed Jeet Singh Marg, Katwaria Sarai, New Delhi-110016

I/28436/2023

Minutes of the meeting held on 06.06.2023 for deliberation on the issue related to the reliability of power supply for UT of Ladakh

List of Participants is attached as Annexure-I.

Background

PDD Ladakh, vide letter dated 22.05.2023 to NRPC and letter dated 05.06.2023 to CEA, has highlighted the issue of reliability of power supply to UT of Ladakh to meet the increasing demand. PDD, Ladakh vide their letters has submitted the following:

1. Ladakh is connected to the National Grid through 220 kV S/c line from Alusteng (JKPTCL) – Drass (PG). The line suffered tower collapse in Feb 2019 due to avalanche and it took almost 5 months to restore the transmission line.
2. The Peak demand of Ladakh region during the winter of 2023 had reached about 70 MW, however, the power availability within Ladakh during the winter season was about 17 MW. Therefore, due to huge gap of around 53 MW in demand and generation, most of the electricity demand of Ladakh during winter season was met through the 220 kV Srinagar Leh S/c Transmission line.
3. PDD Ladakh has proposed for augmentation of the transmission system to ensure that the electricity demand of UT of Ladakh is met in the scenario of outage of the 220 kV Srinagar Leh S/c Transmission line.

The issue was also deliberated in the 64th NRPC meeting on 24.03.2023 and in the VC meeting with CEA, NRPC, CTUIL and POWERGRID held on 01.06.2023.

Deliberations in the meeting

PDD Ladakh raised the issue of the adverse effects on the power supply to Ladakh in case of outage of 220 kV SLTS line which is passing through high mountain ranges and avalanche prone areas. Considering the above, PPD Ladakh proposed for redundant 220 kV line between Drass and Alustung for improved reliability of power supply to Ladakh.

As informed in the meeting, the following projects are either under planning or implementation phase:

1. Laying of cable (800 sq mm XLPE power cable) between Minamarg and Zojila Top section (15 km) of Alusteng – Drass 220 kV section of SLTS line, being implemented by POWERGRID. It was informed in the meeting by POWERGRID that cable laying works would be completed by next season i.e by October, 2024.
2. Transmission system for the proposed Solar Park (2.5 GW) in Kargil (Zangla/Zanskar area), for which 400 kV Zangla - Drass - New Alusteng - New Wanpoh (anchoring at 220 kV Drass and Alusteng) D/c line has been envisaged.
3. 220 kV interconnection from Pang RE Park to Leh/Phyang. The interconnection would come in the matching timeframe of the Pang RE Park. Regarding the time frame of Pang RE project, it was informed that some studies are being carried for the transmission system at high altitudes and after the commencement of the transmission scheme, the system would take around 5 years for completion.

I/28436/2023

4. 50 MW Solar Park with 2.5 Hr BESS under implementation by SECI in Ladakh which would be connected with 66 kV Leh (Phyang) S/s.
5. For providing power supply to NHIDCL to carry out works of Zojila and Z-morh tunnels, two substations have been agreed. On the western portal, 220/33 kV Nilgrar (Gagangeer) by LILO of 220 kV SLTS line and on the eastern portal 66/11 kV Mughalpura substation which is to be connected with 220/66 kV Drass (PG) through 66 kV D/c line. PGCIL is implementing these works for NHIDCL and intimated that works for Eastern Portal have already been awarded with scheduled completion in 2025 and for Western Portal, the works would be awarded shortly.

Member (Power Systems), CEA, stated that the execution of transmission projects in the hilly terrains of Ladakh and J&K is tough and the implementation period is long; therefore, long term approach should be taken while planning for transmission system in the area.

The various options deliberated in the meeting are as follow:

1. 400 kV transmission line (to be charged initially at 220 kV level) from Alusteng/Srinagar to Drass

- The line would provide additional corridor at 220 kV level from Alusteng-Srinagar/Nilgrar (J&K) to Drass (Ladakh). The line would be extended and charged at 400 kV in the timeframe of 2.5 GW solar park at Zangla/Zanskar. SECI/MNRE would be asked to confirm the status of 2.5 GW Solar Park in Kargil/Zanskar.
- CTUIL stated that the 400 kV D/c tower would be of Quad bundle conductor due to high altitude and there may be reactive power management challenges with additional lines. Issues may further increase in summer season due to the lower demand in Ladakh as compared to winters.
- The 400 kV transmission system could be taken up once there is clear visibility of setting up the 2.5 GW solar park in Zangla/Zanskar from SECI/MNRE. .

2. Laying of 220 kV Cable/line from Nilgrar/Gagangeer (J&K) to Drass (Ladakh)

- PDD Ladakh suggested that a new 220 kV line or cable could be proposed from 220/33 kV substation at Nilgrar (Gagangeer) at the western portal of Zojila tunnel to Drass (Ladakh). This line would be parallel to the existing line and would provide 'N-1' contingency in that section of SLTS line which is more prone to avalanche. The approximate distance of the line/cable would be about 60 kms.
- On query regarding the availability of RoW/corridor for implementation of another transmission line through the Zojila section, POWERGRID informed that there is very narrow corridor available for implementation of another EHV line; however, after utilization of that corridor, there may not be any corridor available for construction of another EHV line in future.

I/28436/2023

- CTUIL stated that despite laying of additional line between Nilgrar/Gagangeer to Drass section of SLTS, the whole system would not be 'N-1' compliant as the section from Alusteng to Gangangeer/Nilgrar would still be 220 kV line on S/c towers.
- PDD, Ladakh stated that the section around the Zojila top is the most vulnerable section of the SLTS line; therefore, strengthening of that section by providing additional line has been proposed.
- POWERGRID informed that laying of cable between Minamarg and Zojila Top section (15 km) of Alusteng – Drass 220 kV section of SLTS line was agreed solely to provide the strengthening in the most vulnerable section of SLTS. Further, these works would be completed by next season (October, 2024) and it would take care of the concerns of Ladakh PDD, about the vulnerability of SLTS line passing through avalanche prone zone, to some extent. PDD Ladakh also concurred to the same.

On the suggestion of CEA for laying of 66 kV cable through the Zojila tunnel from Nilgrar substation (with creation of 66 kV level) and Mugalpura substation, Ladakh PDD informed that NHDICL would not allow laying of EHV cable through the tunnel. Further space availability for creation of 66 kV level at Nilgrar S/s would also need to be explored by NHIDCL/POWERGRID.

It was also suggested that Ladakh may explore the possibility of implementation of small scale distributed RE projects with BESS, that would cater the local demand in Ladakh region techno-economically.

After detailed deliberations, following was agreed:

1. As the long term solution, 220 kV interconnection from Pang RE Park to Leh/Phyang has already been agreed and after completion of which, Ladakh would have two independent interconnections from the National Grid.
2. POWERGRID is already laying the cable from Minamarg to Zojila Top section (15 km) of Alusteng – Drass 220 kV section of SLTS line, which would improve the reliability of SLTS line and also addresses PDD Ladakh's reliability concern in Avalanche prone area.

I/28436/2023

Annexure-I**List of Participants of the meeting****Date: 06.06.2022****CEA**

1. Sh. AK Rajput - Member (PS)
2. Sh. Ishan Sharan - Chief Engineer
3. Smt. Manjari Chaturvedi - Director
4. Sh. Nitin Deswal - Deputy Director
5. Ms. Komal Dupare - Asst. Director
6. Sh. Kanhaiya Singh Kushwaha - Asst. Director

CTUIL

1. Sh. Kashish Bhambhani - GM
2. Ms. Anikta Singh - Chief Manager

PDD Ladakh

1. Sh. Tsewang Paljor - Chief Engineer

POWERGRID

1. Sh. Anil Sharma – CGM (Projects) NR-II

Bikaner_2 ERS study proposal in respect of SD of 400kV Bikaner(PG)-Bikaner(RS) D/C

Basecase Assumptions	Expected restoration
Rajasthan Demand	15500 MW
Rajasthan Solar	2900 MW (restricted)
Rajasthan Wind	1800 MW (restricted)
STATCOM -1 & 2 @ Bhadla_2	in service
400kV Bhadla(RS)-Bikaner(RS) D/C	out of service
400kV Bhadla-Jodhpur	out of service
400kV Akal-Jodhpur	out of service
400kV Jaisalmer-Barmer D/C	out of service
400kV Bikaner_2-Khetri Q/C	in service

RAJASTHAN WIND 1800 and RAJASTHAN SOLAR 2900 MW											
Element	Basecase Loading / Voltage	Case 1: Outage of 400kV Bikaner(PG)-Bikaner(RS) D/C	Case 1 without STATCOM 1&2 @ Bhadla_2	Case 2 : Charging of 400kV Bikaner(PG)-Bikaner_2_1 on ERS	Case 2 without STATCOM 1&2 @ Bhadla_2	Case 3 : Charging of 400kV Bikaner(PG)-Bikaner(RS)-1 on case 2	Case 4 : Final charging of 400kV Bikaner(PG)-Bikaner_2 D/C	Case 4 without STATCOM 1&2 @ Bhadla_2	Case 5 : Revival of 400kV Bhadla-Jodhpur over Case 4	Case 6 : Revival of 400kV Jaisalmer Barmer DC over Case 5	Case 7 : Revival of 400kV Akal Jodhpur over Case 6
		Backing required : 1023 MW @ Bikaner(PG) + 700 MW @ Fatehgarh_1	Backing required : 1023 MW @ Bikaner(PG) + 700 MW @ Fatehgarh_1 + 500 MW @ Fatehgarh_2	Backing required : 200 MW @ Fatehgarh_1 (Due to 150 MVAR dynamic MVAR deficit @ Fatehgarh_2)	Backing required : 700 MW @ Fatehgarh_1 + 400 MW @ Fatehgarh_2	Backing required : 100 MW @ Fatehgarh_1 (Due to 50 MVAR dynamic MVAR deficit @ Fatehgarh_2)	Backing required : 700 MW @ Fatehgarh_1 + 300 MW @ Fatehgarh_2	Full Rajasthan Solar	Full Rajasthan Solar	Full Rajasthan Solar	Full IGs RE
400 kV Bikaner(PG)-Bikaner(RS)-1	1172	0	0	0	0	1579	0	0	0	0	0
400 kV Bikaner(PG)-Bikaner(RS)-2	1172	0	0	0	0	0	0	0	0	0	0
400kV Bikaner(PG)-Bikaner_2 (ERS)	0	0	0	1544	1481	1137	0	0	0	0	0
400kV Bikaner(PG)-Bikaner_2 D/C final	0	0	0	0	0	0	1792	1720	1792	1786	1792
765kV Bhadla-Bikaner -1	1765	1548	1479	1645	1512	1751	1676	1543	1687	1676	1687
765kV Bhadla-Bikaner -2	1765	1548	1479	1645	1512	1751	1676	1543	1687	1676	1687
765kV Bhadla_2-Bikaner -1	994	796	757	870	787	998	899	816	913	910	918
765kV Bhadla_2-Bikaner -2	994	796	757	870	787	998	899	816	913	910	918
765 kV Bhadla_2-Ajmer-1	1587	1612	1529	1668	1525	1821	1658	1517	1652	1638	1648
765 kV Bhadla_2-Ajmer-1	1587	1612	1529	1668	1525	1821	1658	1517	1652	1638	1648
765kV Bikaner-Moga-1	1353	1394	1355	1422	1351	1310	1409	1340	1422	1418	1424
765kV Bikaner-Moga-2	1353	1394	1355	1422	1351	1310	1409	1340	1422	1418	1424
765kV Bikaner-Khetri-1	1788	2000	1936	1869	1762	1635	1820	1717	1831	1825	1833
765kV Bikaner-Khetri-2	1788	2000	1936	1869	1762	1635	1820	1717	1831	1825	1833
765kV Fatehgarh_2-Bhadla-1	727	556	450	668	474	691	694	500	693	698	721
765kV Fatehgarh_2-Bhadla-2	727	556	450	668	474	691	694	500	693	698	721
765kV Fatehgarh_2-Bhadla 2-1	1280	1123	1247	1022	1247	1225	1268	1043	1267	1263	1285
765kV Fatehgarh_2-Bhadla 2-2	1280	1123	1247	1022	1247	1225	1268	1043	1267	1263	1285
400 kV AREPRL Voltage	387	397	416	391	414	394	389	413	388	388	385
765kV Fatehgarh_2 Voltage	746	758	793	750	788	754	748	787	747	747	743
765kV Bhadla_2 Voltage	761	765	792	760	789	764	760	788	759	759	758
765kV Bhadla Voltage	756	762	792	757	788	762	756	787	753	753	753
765kV Bikaner Voltage	759	761	786	757	783	765	758	784	755	756	755
Station	Fault level (MVA)	Fault level (MVA)	Fault level (MVA)	Fault level (MVA)	Fault level (MVA)	Fault level (MVA)	Fault level (MVA)	Fault level (MVA)	Fault level (MVA)	Fault level (MVA)	Fault level (MVA)
400kV BIKANER_PG	24790	15980	19276	25304	19905	20079	20087	20087	20087	20087	20087
400 kV BHADLA-PG	20685	19535	20011	20688	20086	21130	21172	21173	21173	21173	21173
400kV BHADLA II	19671	18595	19030	19667	19059	19620	19641	19641	19641	19641	19641
400 kV FATEHGARH-II	14328	13681	13941	14324	13982	14382	14382	14382	14382	14382	14382
400kV FATEHGARH_1	9839	9534	9657	9837	9677	9771	9775	9775	9775	9775	9775
765kV BIKANER-PG	32956	27543	29495	32872	29818	30313	30336	30336	30336	30336	30336
765kV BHADLA-PG	23050	21170	21910	23038	22028	22692	22719	22720	22720	22720	22720
765kV BHADLA II	26092	24192	24938	26075	25056	25569	25591	25591	25591	25591	25591
765kV FATEHGARH-II	19076	17926	18383	19067	18455	18813	18828	18828	18828	18828	18828

RAJASTHAN WIND 500 MW and FULL RAJASTHAN SOLAR

Element	Basecase Loading / Voltage	Case 1: Outage of 400kV Bikaner(PG)-Bikaner(RS) D/C	Case 2: Charging of 400kV Bikaner(PG)-Bikaner 2-1 on ERS	Case 3: Charging of 400kV Bikaner(PG)-Bikaner(RS)-1 on case 2	Case 4: Final charging of 400kV Bikaner(PG)-Bikaner 2 D/C	Case 5: Revival of 400kV Bhadla-Jodhpur over Case 4
		Backing required : 1023 MW @ Bikaner(PG) + 400 MW @ Fatehgarh_1	Backing required : 300 MW @ Fatehgarh_1	Backing required : 200 MW @ Fatehgarh_1	Backing required : 200 MW @ Fatehgarh_1	Full ISGS RE
400 kV Bikaner(PG)-Bikaner(RS)-1	1206	0	0	1635	0	0
400 kV Bikaner(PG)-Bikaner(RS)-2	1206	0	0	0	0	0
400kV Bikaner(PG)-Bikaner 2 (ERS)	0	0	1546	1124	0	0
400kV Bikaner(PG)-Bikaner 2 D/C final	0	0	0	0	1794	1764
765kV Bhadla-Bikaner -1	1768	1583	1622	1731	1653	1593
765kV Bhadla 2-Bikaner -2	1768	1583	1622	1731	1653	1593
765kV Bhadla 2-Bikaner -1	992	809	846	978	876	870
765kV Bhadla 2-Bikaner -2	992	809	846	978	876	870
765 kV Bhadla 2-Ajmer-1	1598	1689	1677	1526	1668	1611
766 kV Bhadla 2-Ajmer-1	1598	1689	1677	1526	1668	1611
765kV Bikaner-Moga-1	1335	1405	1396	1281	1383	1367
765kV Bikaner-Moga-2	1335	1405	1396	1281	1383	1367
765kV Bikaner-Khetri-1	1770	2035	1847	1605	1798	1766
765kV Bikaner-Khetri-2	1770	2035	1847	1605	1798	1766
765kV Fatehgarh 2-Bhadla-1	724	616	642	665	667	738
765kV Fatehgarh 2-Bhadla-2	724	616	642	665	667	738
765kV Fatehgarh 2-Bhadla 2-1	1283	1206	1227	1204	1248	1268
765kV Fatehgarh 2-Bhadla 2-2	1283	1206	1227	1204	1248	1268
400 kV AREPBI Voltage	386	393	392	395	391	387
765kV Fatehgarh 2 Voltage	745	751	750	755	749	746
765kV Bhadla 2 Voltage	760	761	760	765	761	760
765kV Bhadla Voltage	754	757	756	761	756	755
765kV Bikaner Voltage	759	757	757	765	758	758

Note :

In case of tripping of 765kV Bikaner-Khetri-1/2, loading on 400kV Bikaner-Bikaner_2 (ERS) would go beyond its thermal rating. SPS needs to be implemented in case loading of 400kV Bikaner-Bikaner_2 (ERS) crosses 1750 MVA.

Observation :

- To facilitate the SD of 400kV Bikaner(PG)-Bikaner (RS) D/C without ERS option, a total STDA curtailment of 1423-1723 MW would be required
- STDA curtailment of 200-300 MW would be required if quid mouse ERS on 400kV Bikaner-Bikaner_2 becomes operational
- Simultaneous operation of ERS and 400kV Bikaner(PG)-Bikaner(RS) 1 is not desirable as the loading of later would increase beyond the permissible line loading limit of 1450 MVA.
- With final commissioning of 400kV Bikaner-Bikaner_2 D/C, STDA curtailment of 100-200 MW at Fatehgarh_1 would be required for keeping the RE pocket n-1 compliant
- With revival of 400kV Rajasthan lines in gradual manner as indicated above, generation restriction of Rajasthan Solar and STDA curtailment would be removed.
- It may be noted that **in case of revival of 400kV Bhadla(RS)-Bikaner(RS) D/C, no curtailment of Rajasthan Solar or ISGS RE would be there after commissioning of 400kV Bikaner-Bikaner_2 DC**

**प्रचालन समन्वय उपसमिति की बैठक
मई - 2023**

पिछले एक साल में आवृत्ति की स्थिति

आवृत्ति बैंड	मई 2022	जून 2022	जुलाई 2022	अगस्त 2022	सितम्बर 2022	अक्टूबर 2022	नवम्बर 2022	दिसंबर 2022	जनवरी 2023	फ़रवरी 2023	मार्च 2023	अप्रैल 2023	मई 2023
< 49.7 Hz(%)	0.27	0.42	0.42	0.49	0.17	0.04	0.13	1.11	1.25	0.32	0.16	0.24	0.24
<49.8 Hz(%)	1.94	2.41	1.78	2.02	0.91	0.46	0.76	3.96	3.60	1.95	1.26	1.68	1.48
<49.9 Hz(%)	9.83	12.45	7.82	8.77	5.94	4.88	6.70	12.78	13.30	10.75	9.03	10.54	9.83
49.90-50.05 Hz(%)	72.23	73.38	73.45	75.77	80.77	78.27	77.00	57.39	58.70	64.68	63.84	67.90	68.48
50.05-50.10 Hz(%)	12.95	11.46	14.84	11.99	11.55	14.04	13.88	11.99	15.26	14.59	17.86	12.54	13.25
>50.10 Hz(%)	4.11	2.43	3.58	3.00	1.65	2.63	2.30	17.84	12.34	8.49	7.99	6.46	8.44
>50.20 Hz(%)	0.88	0.28	0.31	0.47	0.08	0.18	0.12	4.07	1.83	1.49	1.28	0.88	0.77
औसत आवृत्ति	50.00	49.99	50.00	50.00	50.00	50.00	50.00	50.00	50.00	50.00	50.00	49.99	49.99

आवृत्ति की स्थिति: मई -2022 से 2023

आवृत्ति की स्थिति: मई '22 से मई '23

Frequency(Hz)	% of Time
<49.90	9.83
49.90-50.05	68.48
>50.05	21.69

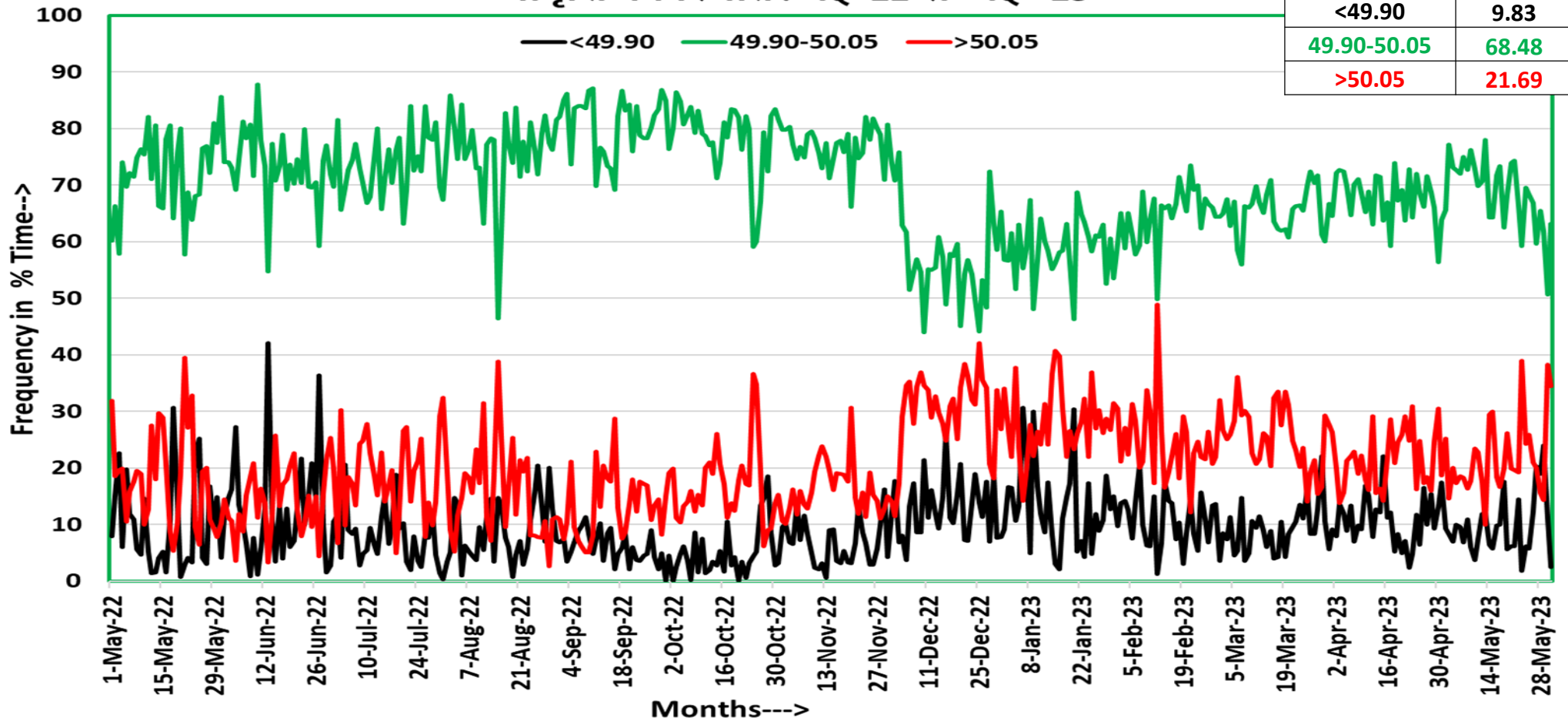

मई -2023 के दौरान आवृत्ति की स्थिति (As per 5 Minute SCADA data)

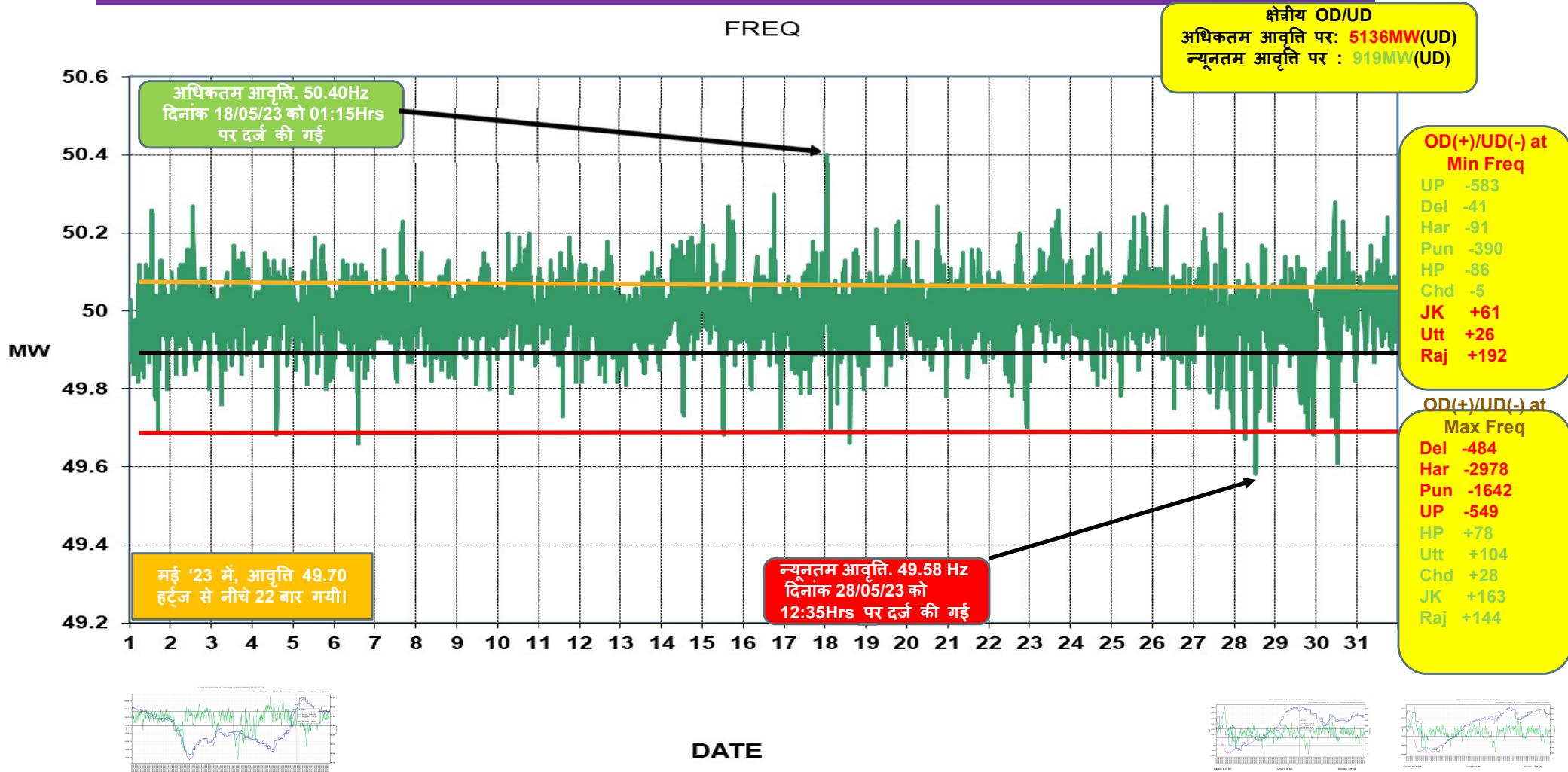

मई -2023 के दौरान अधिकतम मांग (Demand Met), अधिकतम ऊर्जा खपत (Energy consumption) और अब तक का कीर्तिमान (राज्यों द्वारा जमा आंकड़ों के अनुसार)



राज्य	अधिकतम मांग (MW) (in May'23)	दिनांक / समय	रिकॉर्ड अधिकतम मांग (in MW) (upto Apr'23)	दिनांक / समय	अधिकतम ऊर्जा खपत (MU) (in May'23)	दिनांक	रिकॉर्ड अधिकतम ऊर्जा खपत (MU) (Upto Apr'23)	दिनांक
पंजाब	11940	23.05.23 at 21:30	14295	22.08.22 को 14:45 बजे	233.4	23.05.2023	334.45	29.06.22
हरियाणा	10020	23.05.23 at 15.45	12768	28.06.22 को 11:56 बजे	205.4	23.05.2023	266.15	07.07.21
राजस्थान	16470	23.05.23 at 13:00	17206	18.01.23 को 14:30 बजे	330.9	23.05.2023	328.86	09.09.22
दिल्ली	6916	23.05.23 at 15.31	7695	29.06.22 को 15:10 बजे	135.0	23.05.2023	153.52	28.06.22
उत्तर प्रदेश	26166	22.05.23 at 22:08	26589	09.09.22 को 21:39 बजे	521.7	22.05.2023	547.40	19.08.22
उत्तराखंड	2415	23.05.23 at 20:00	2594	14.06.22 को 21:00 बजे	49.8	22.05.2023	54.27	15.06.22
हिमाचल प्रदेश	1702	10.05.23 at 08:00	2071	06.01.23 को 09:45 बजे	32.3	19.05.2023	37.0	06.01.23
जम्मू और कश्मीर (UT) तथा लद्दाख (UT)	2823	15.05.23 at 21:00	3044	02.02.23 को 20:00 बजे	57.8	12.05.2023	64.6	20.01.23
चंडीगढ़	321	23.05.23 at 15:30	426	08.07.21 को 15:00 बजे	6.9	23.05.2023	8.41	08.07.21
उत्तरी क्षेत्र #	72862	23.05.23 at 14:45	77006	28.06.22 को 11:50 बजे	1554.9	23.05.2023	1737.09	28.06.22

उत्तरी क्षेत्र अधिकतम मांग (Demand Met) as per SCADA Data

क्षेत्रीय विद्युत आपूर्ति (Demand) मई 2022 बनाम मई 2023 (As per 5 Minute SCADA data)

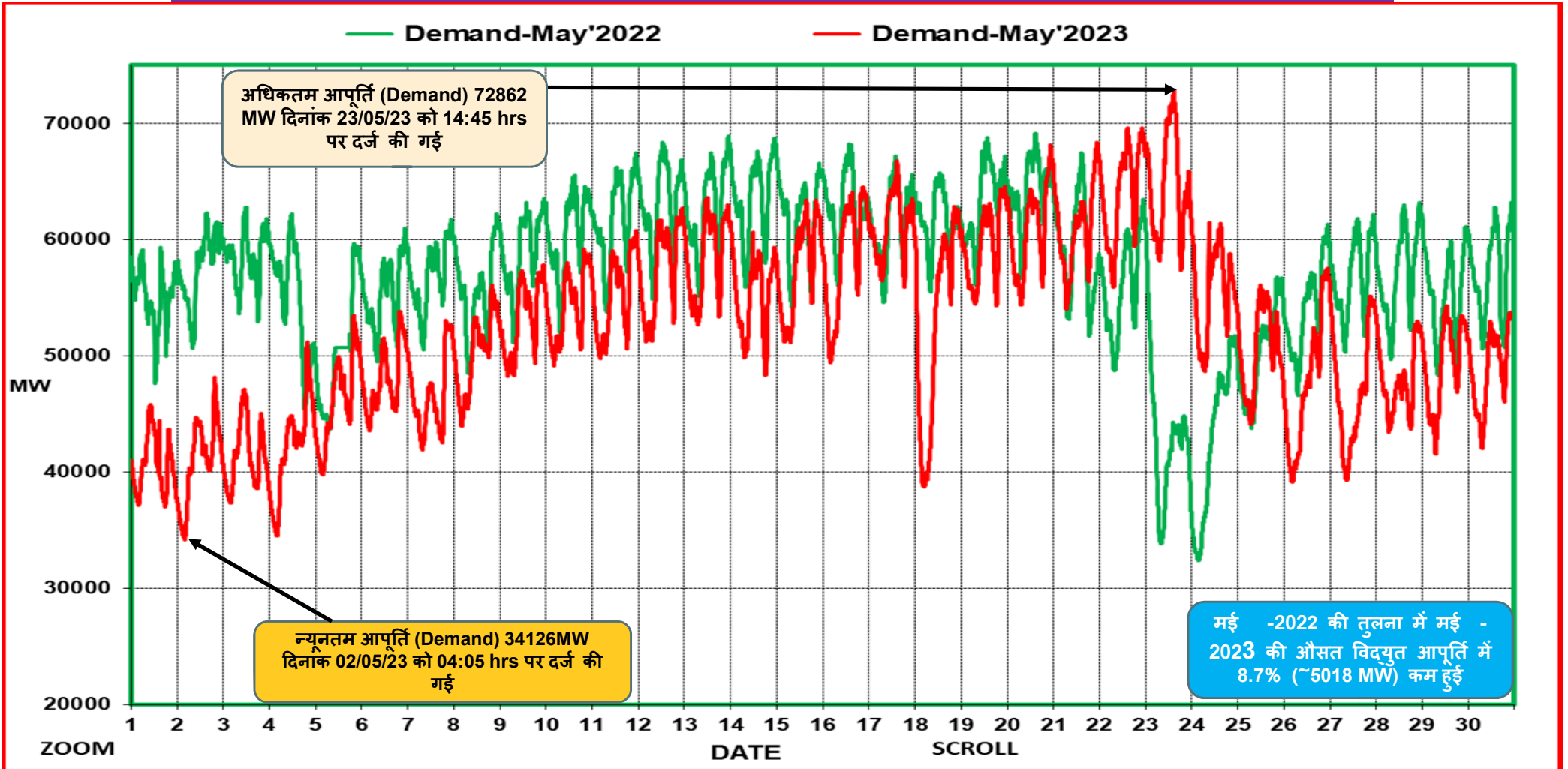

उत्तरी क्षेत्र की औसत ऊर्जा खपत में वृद्धि(% में) मई -2023/ मई -2022
/ मई -2021

राज्य	मई -2021	मई -2022	मई -2023	% वृद्धि (मई -2022 vs मई -2021)	% वृद्धि (मई -2023 vs मई -2022)
पंजाब	150.0	204.2	170.3	36.1%	-16.6%
हरियाणा	133.9	182.0	164.4	35.9%	-9.6%
राजस्थान	212.8	288.8	264.8	35.8%	-8.3%
दिल्ली	74.6	120.6	100.7	61.6%	-16.5%
उत्तर प्रदेश	340.8	454.3	425.4	33.3%	-6.4%
उत्तराखंड	34.5	44.9	43.3	30.2%	-3.7%
चंडीगढ़	4.1	5.9	5.0	43.9%	-16.3%
हिमाचल प्रदेश	26.7	32.4	29.2	21.1%	-9.7%
जम्मू और कश्मीर (UT) तथा लद्दाख (UT)	51.6	48.0	55.1	-7.0%	14.9%
उत्तरी क्षेत्र	1029.1	1381.1	1262.0	34.2%	-8.6%

Punjab Consumption

—2021 —2022 —2023

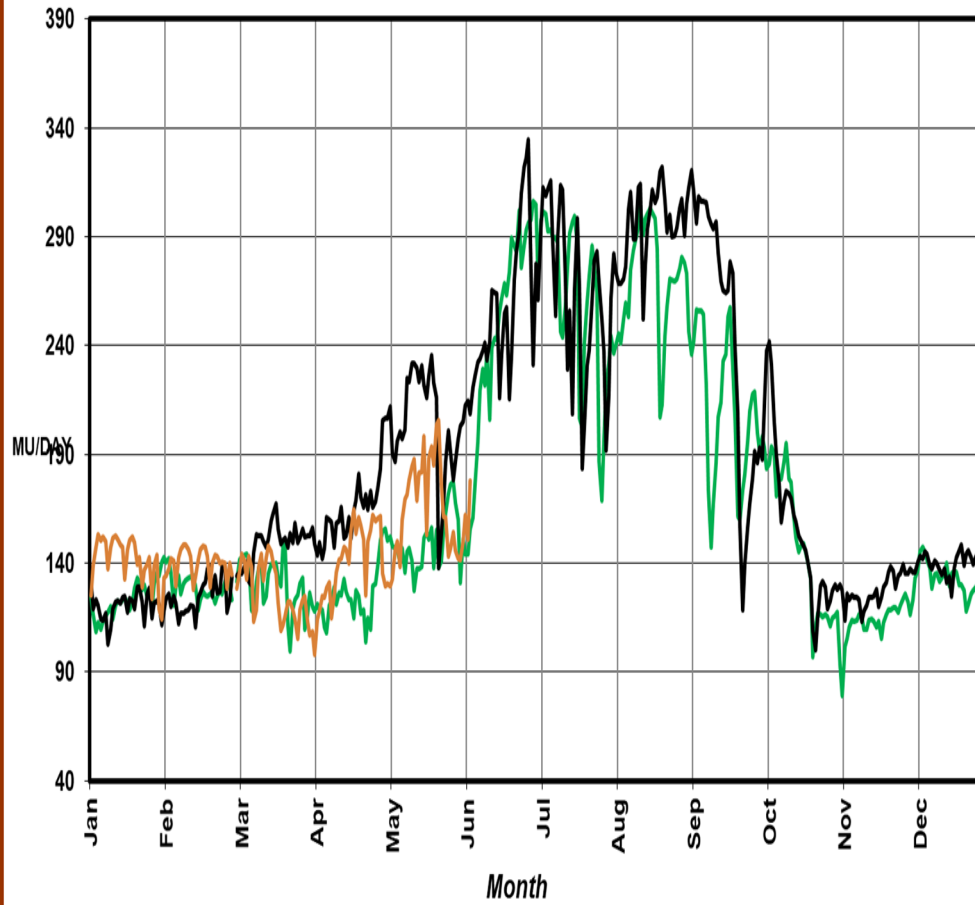

Haryana Consumption

—2021 —2022 —2023

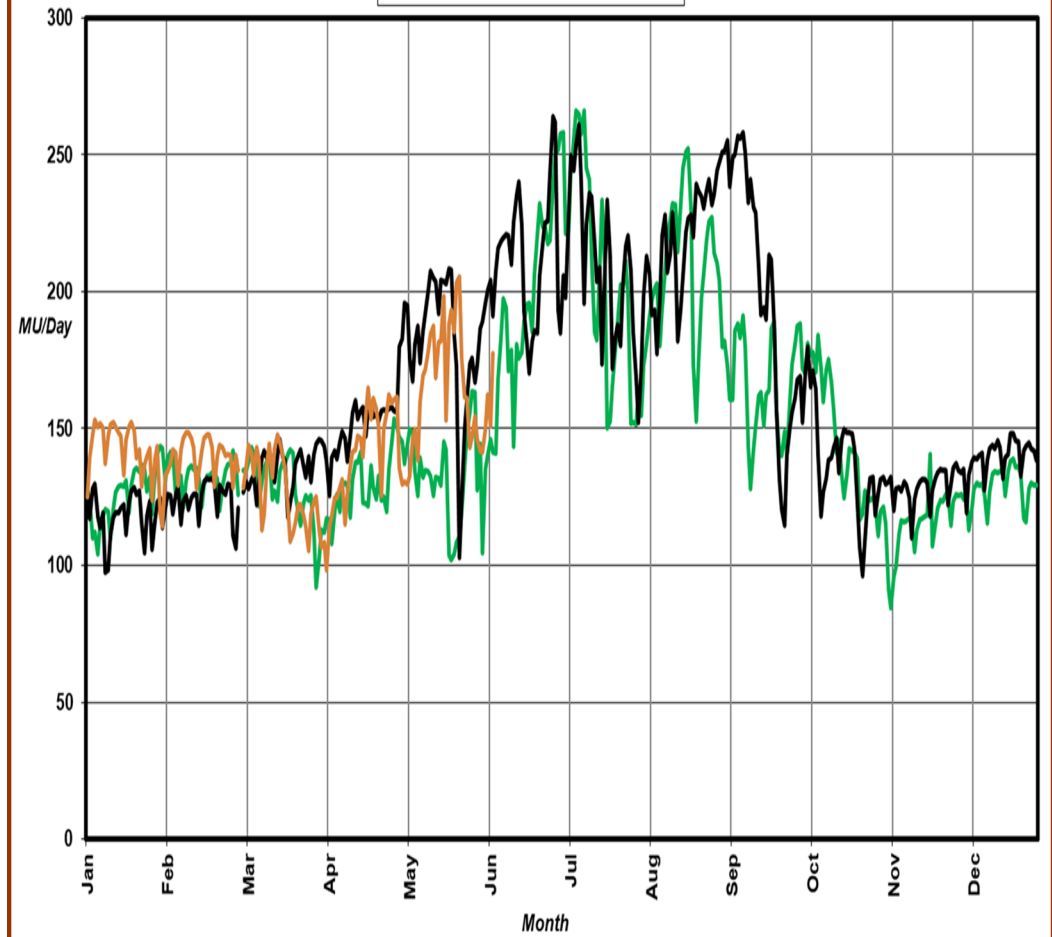

Rajasthan Energy Consumption

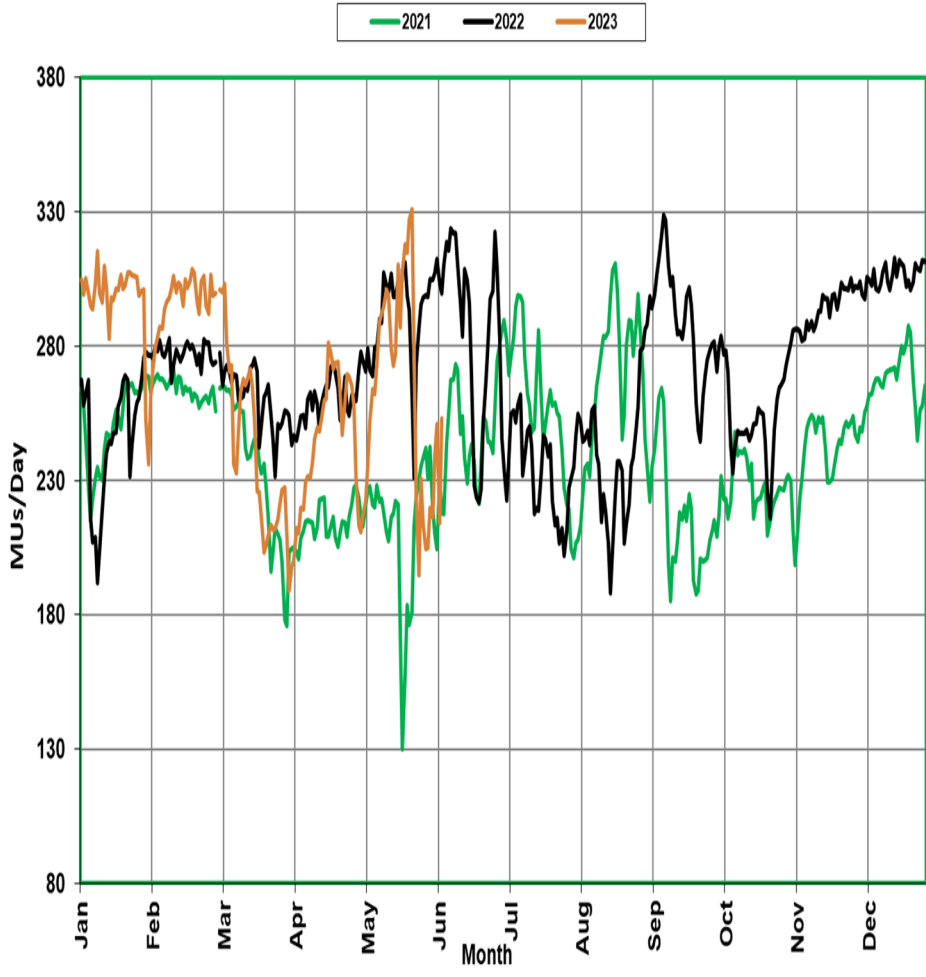

Delhi Consumption

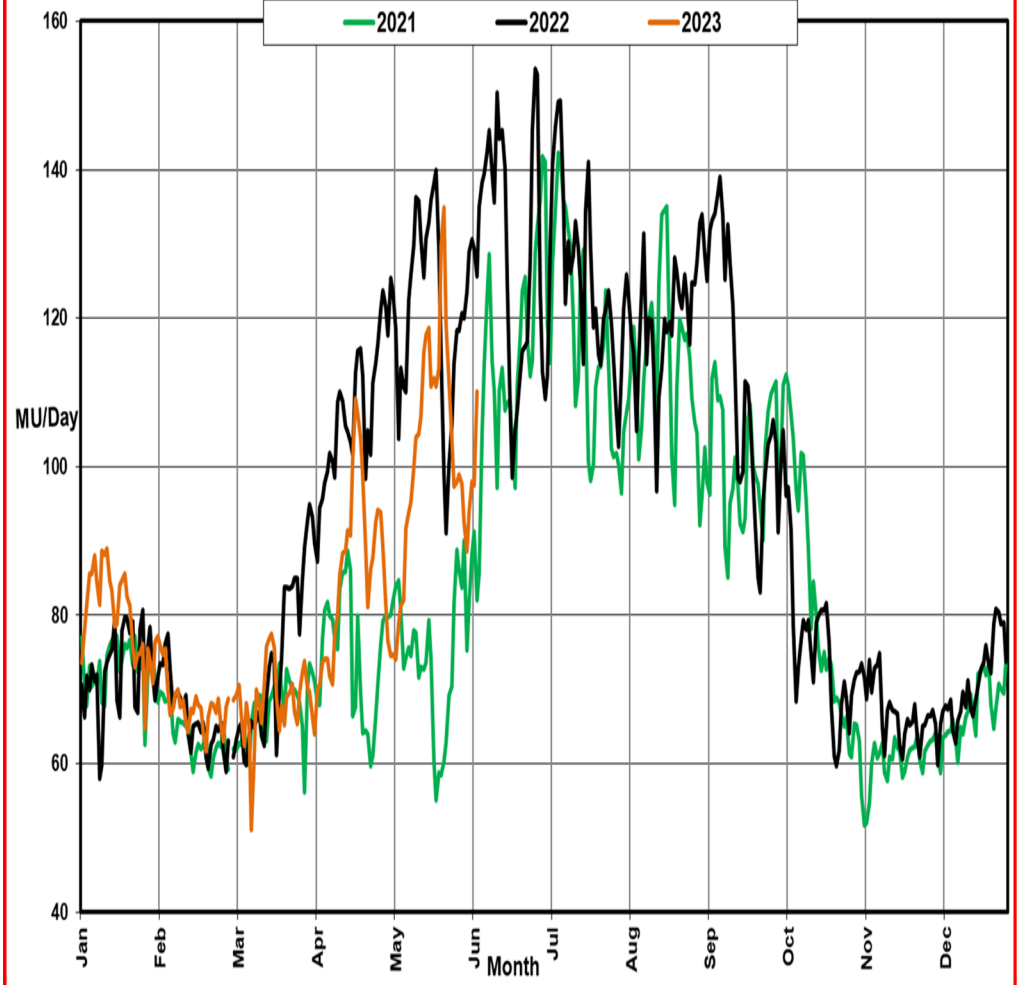

Delhi Consumption

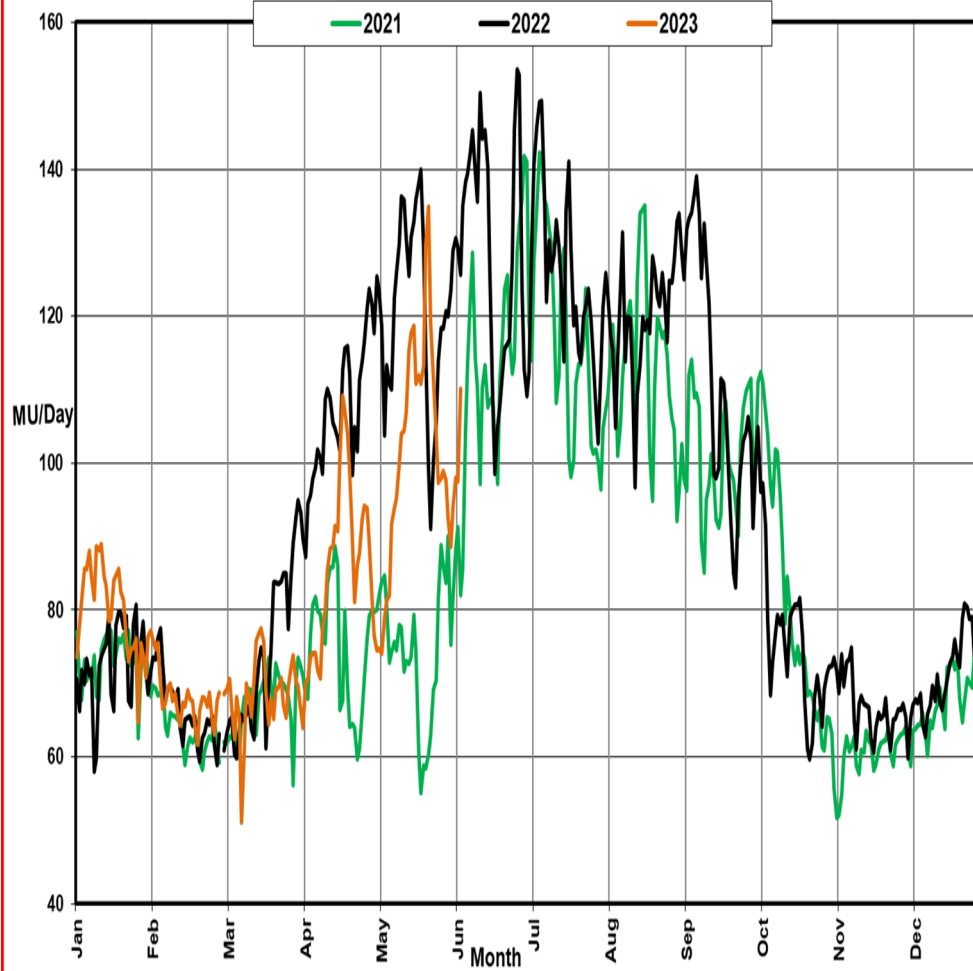

Uttar Pradesh Consumption

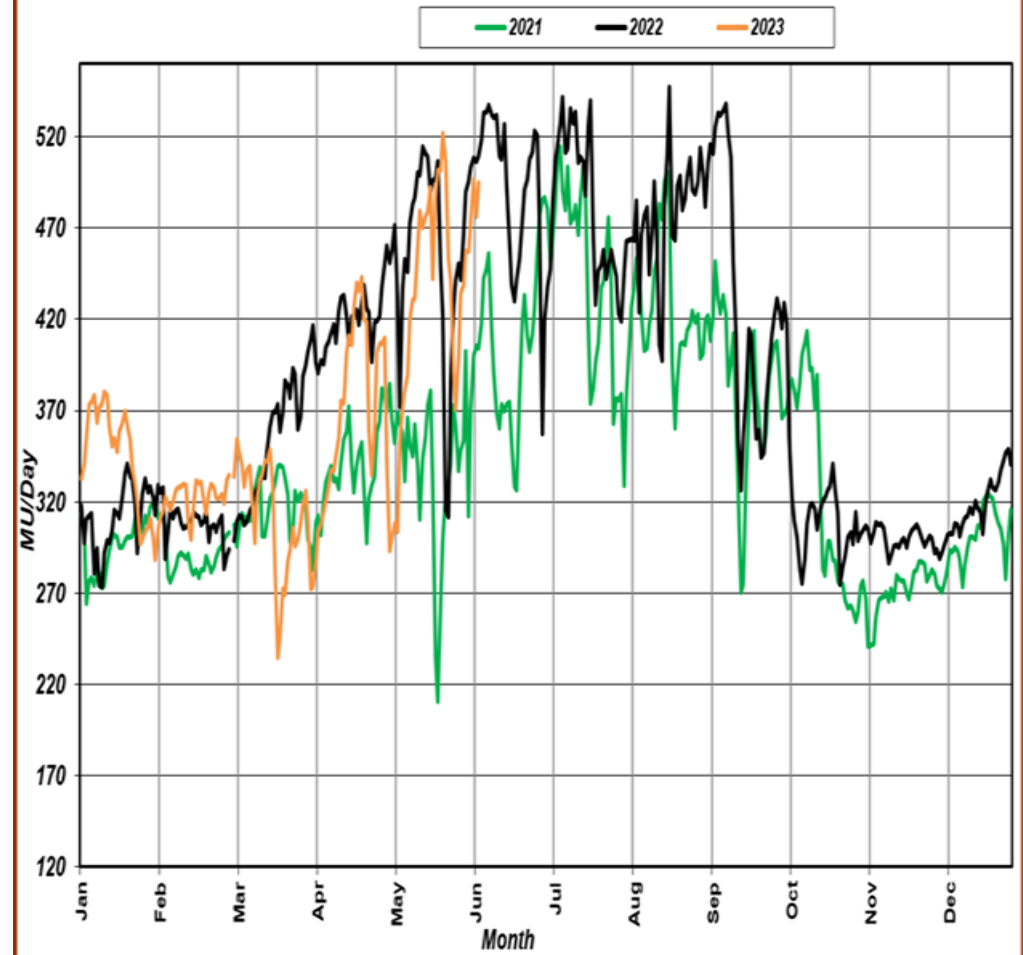

HP CONSUMPTION

— 2021 — 2022 — 2023

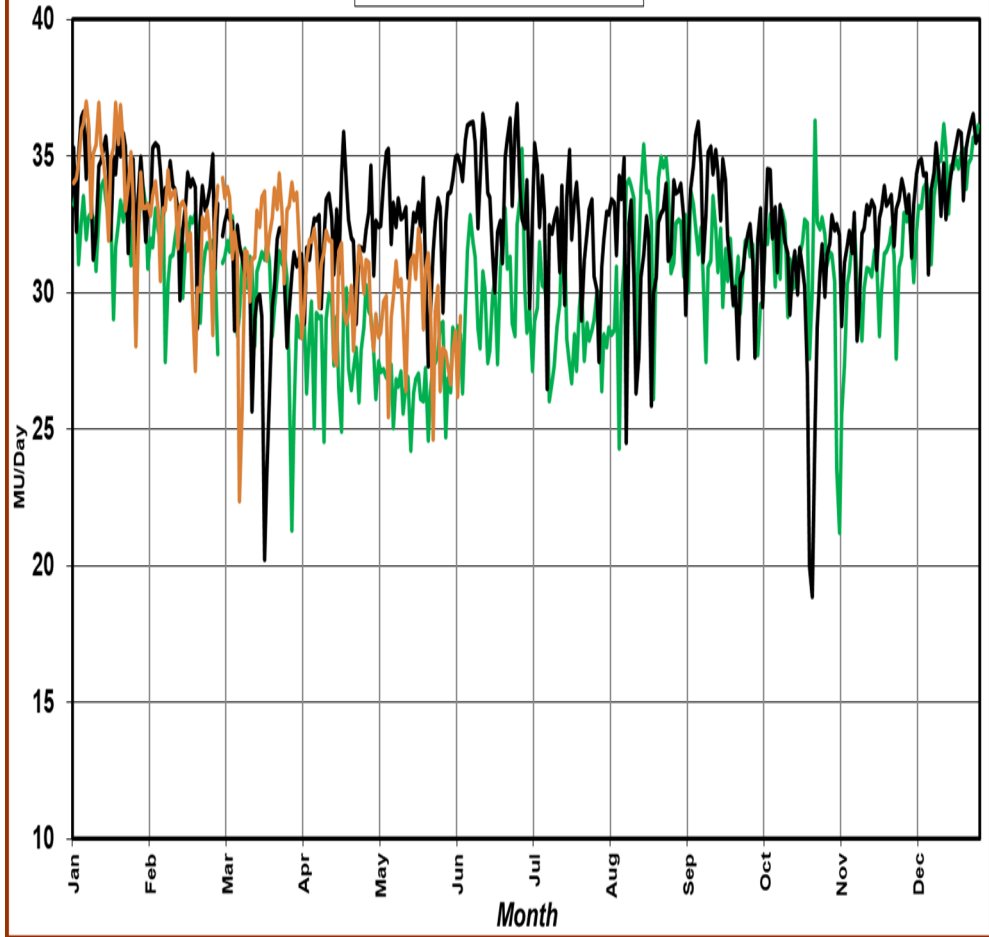

J & K Energy Consumption Pattern

— 2021 — 2022 — 2023

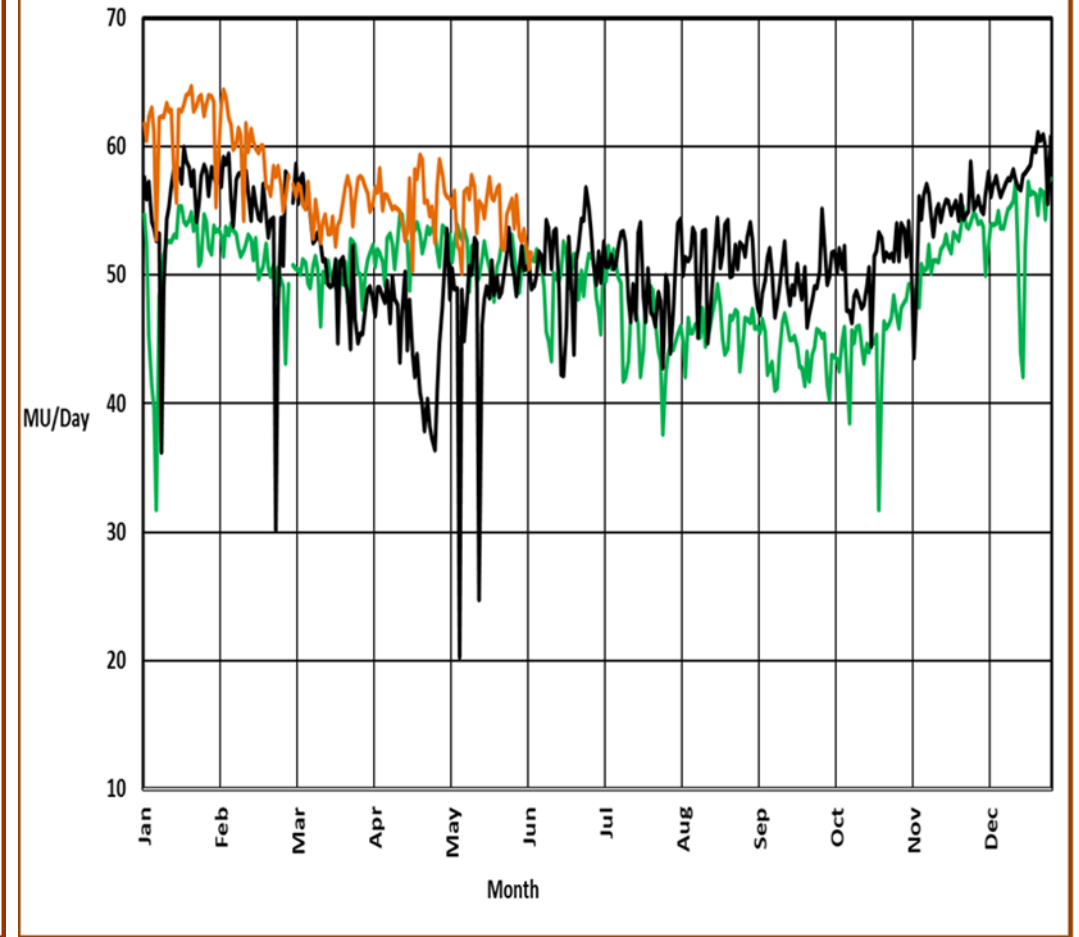

Uttarakhand Consumption

— 2021 — 2022 — 2023

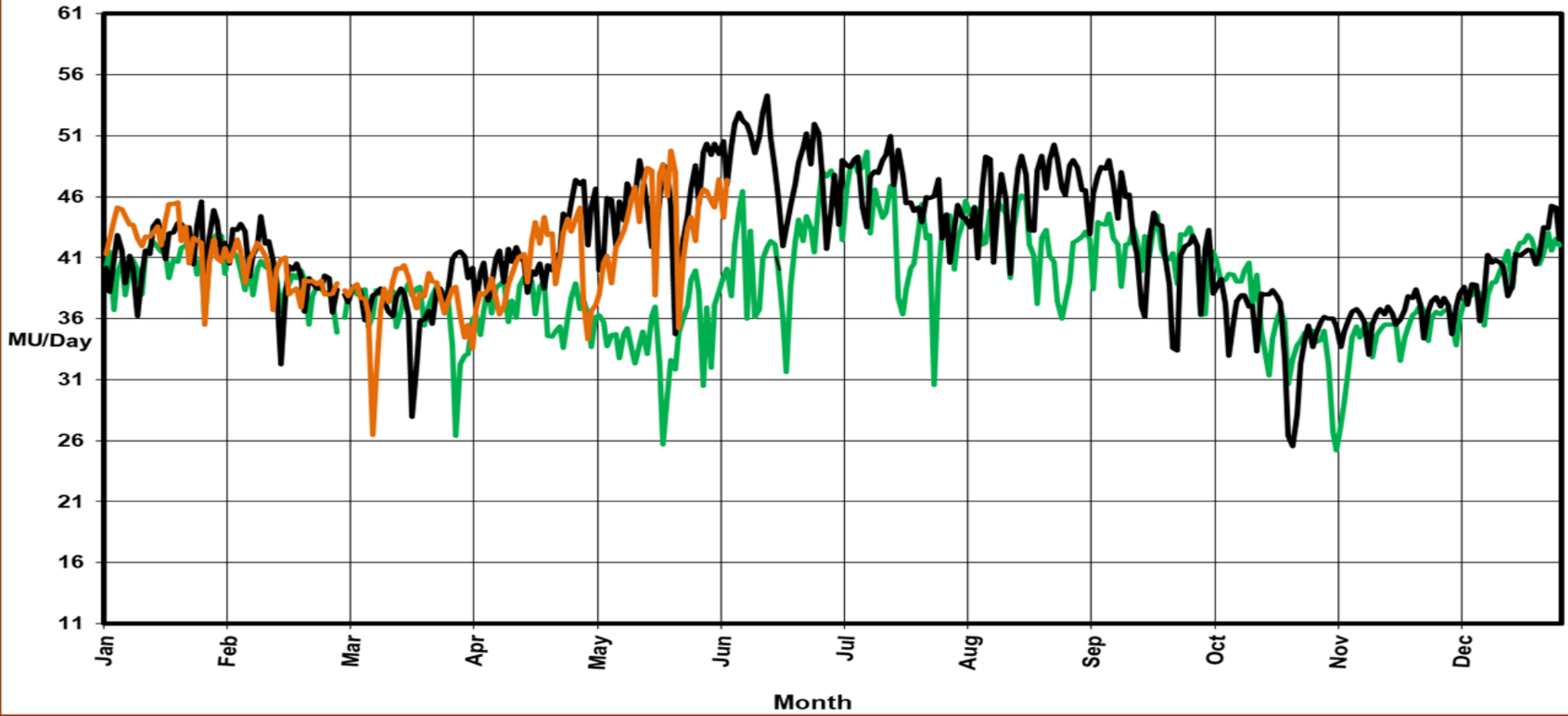

उत्तरी क्षेत्र की ऊर्जा खपत(MUs)

Northern Region Energy Consumption Pattern

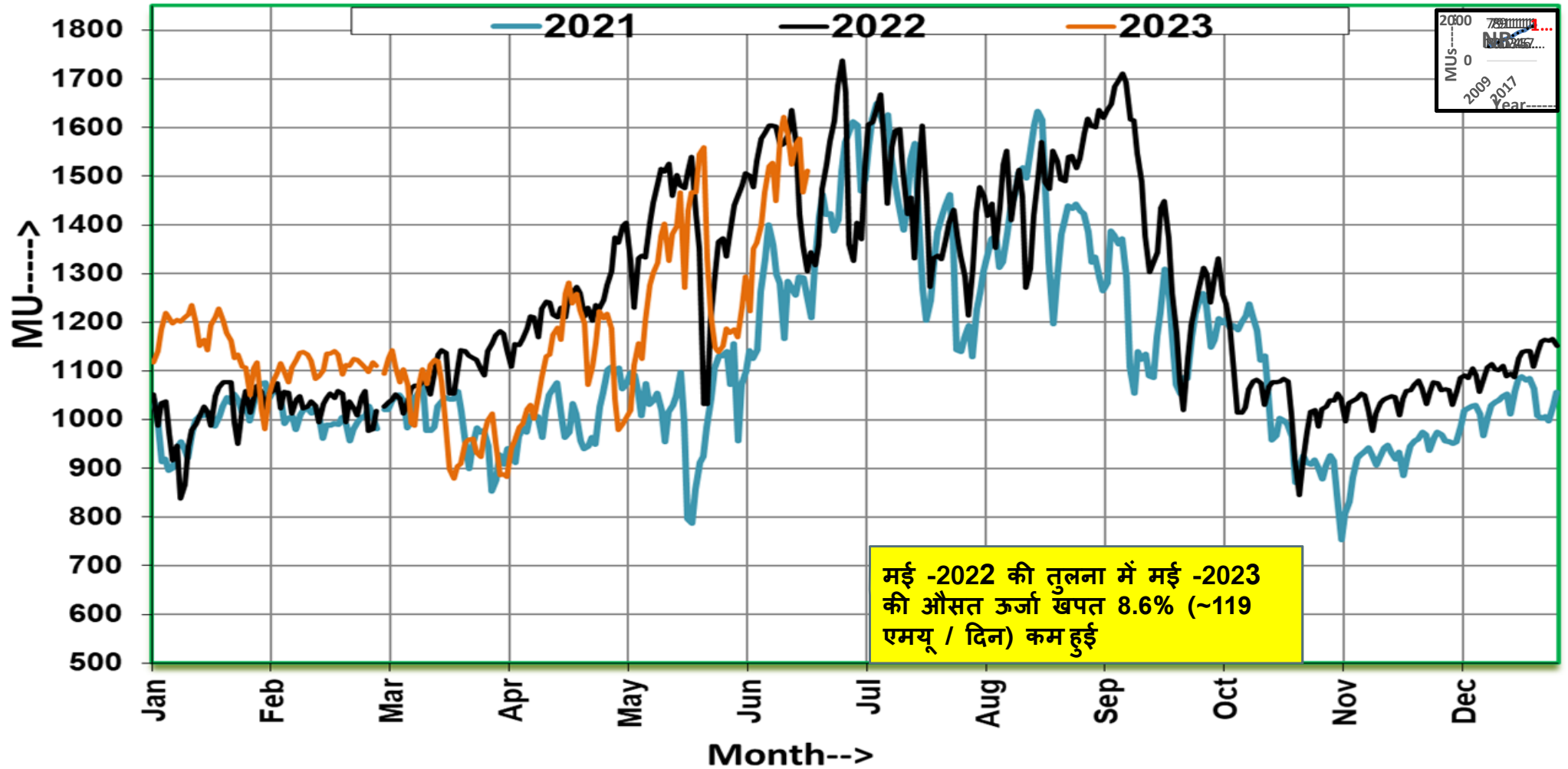

उत्तरी क्षेत्र की तापीय (Thermal) उत्पादन की स्थिति(Mus/Day)

Northern Regional Thermal Generation

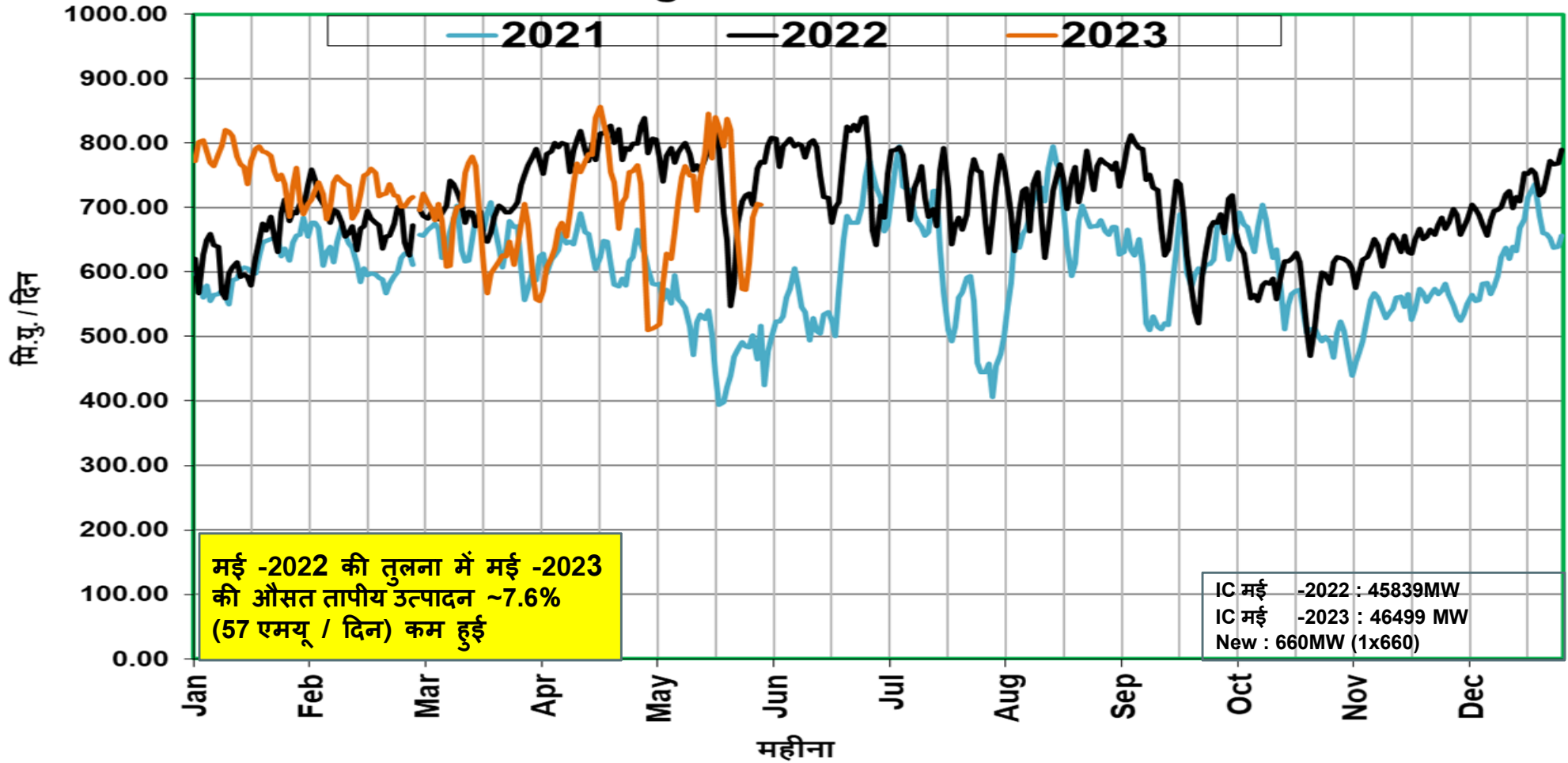

उत्तरी क्षेत्र की जलीय (हाइड्रो) उत्पादन की स्थिति (Mus/Day)

Northern Regional Hydro Generation

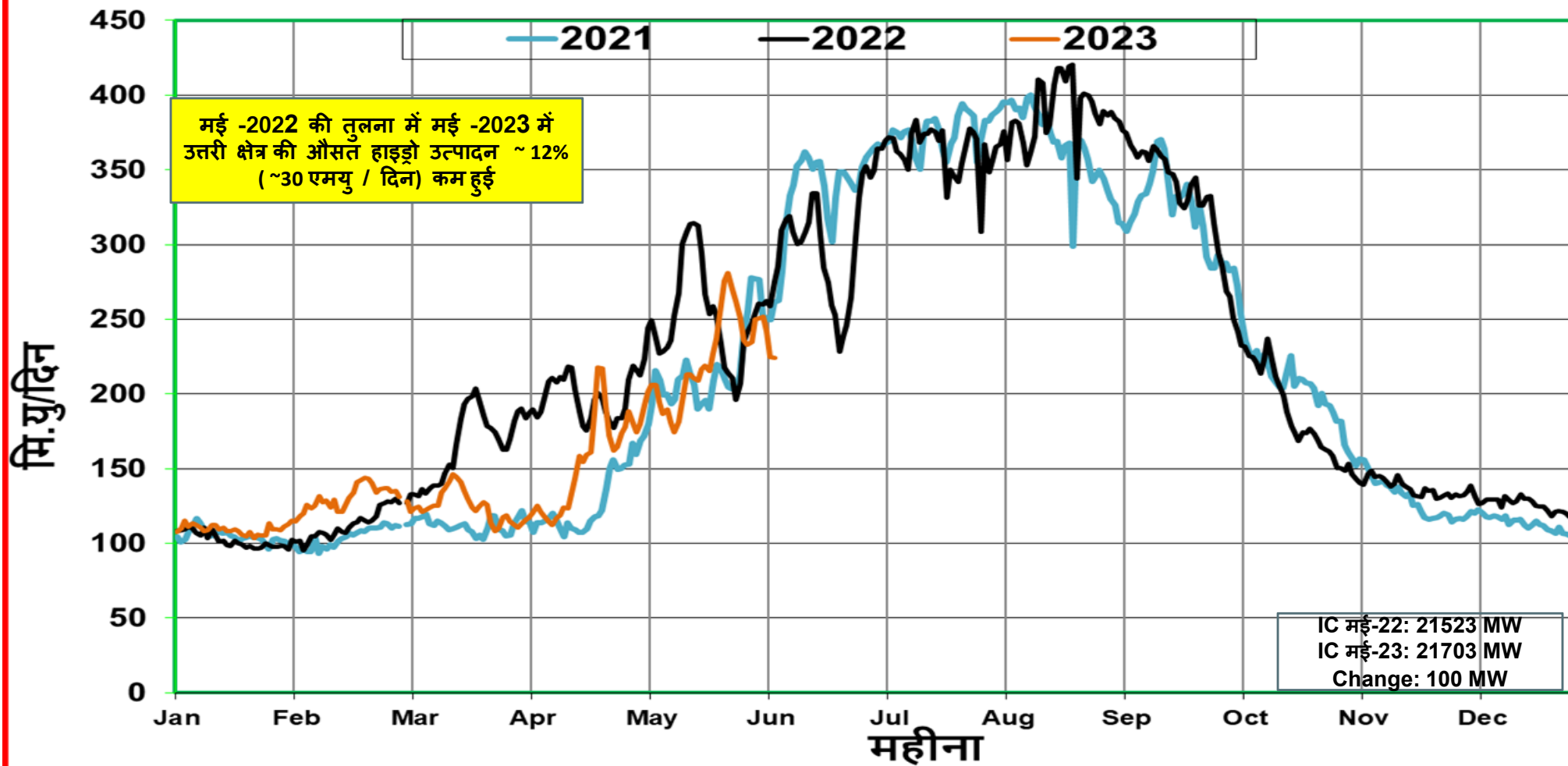

उत्तरी क्षेत्र की नाभिकीय उत्पादन की स्थिति (Mus/Day)

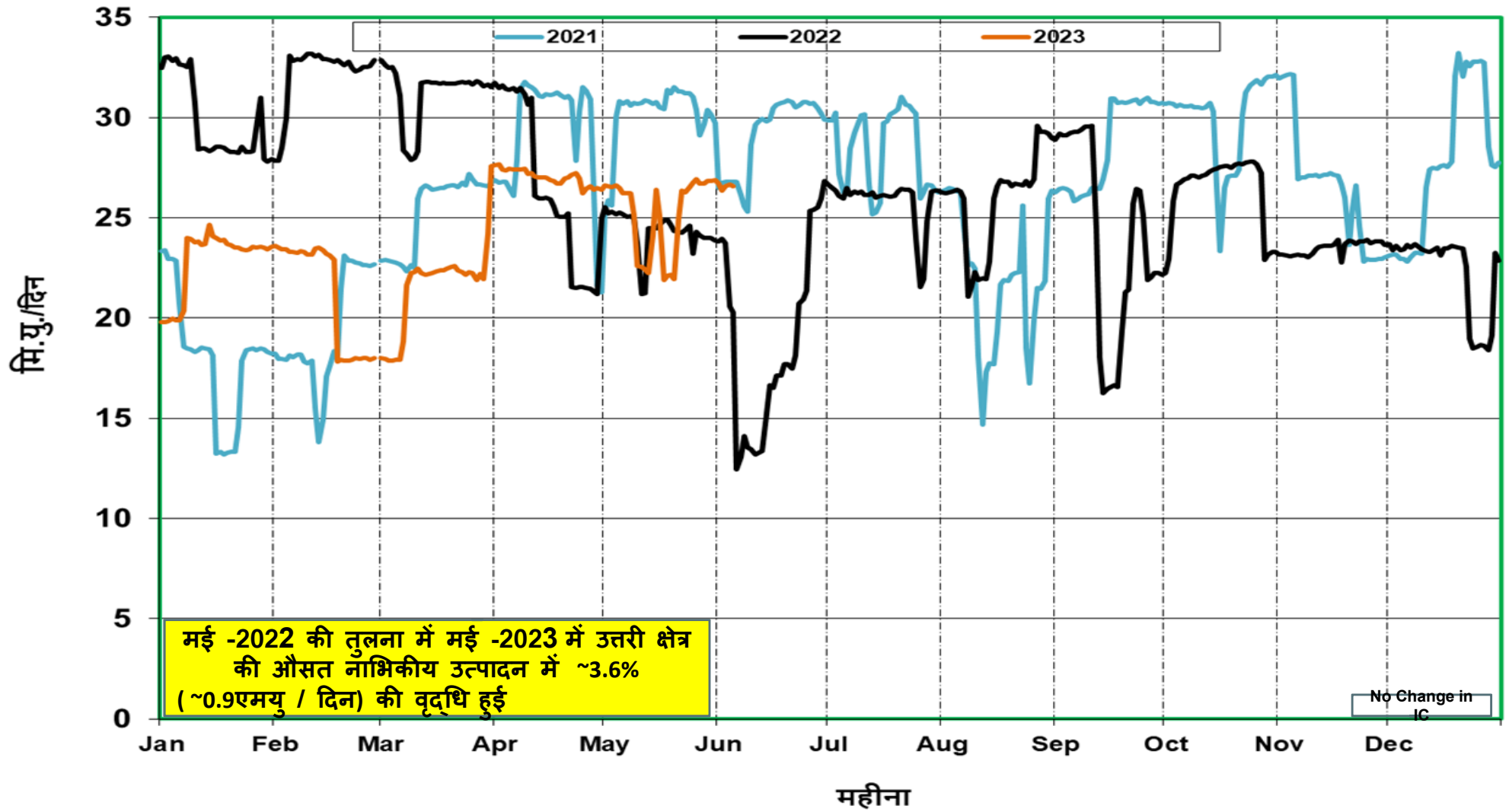

(Mus/Day)

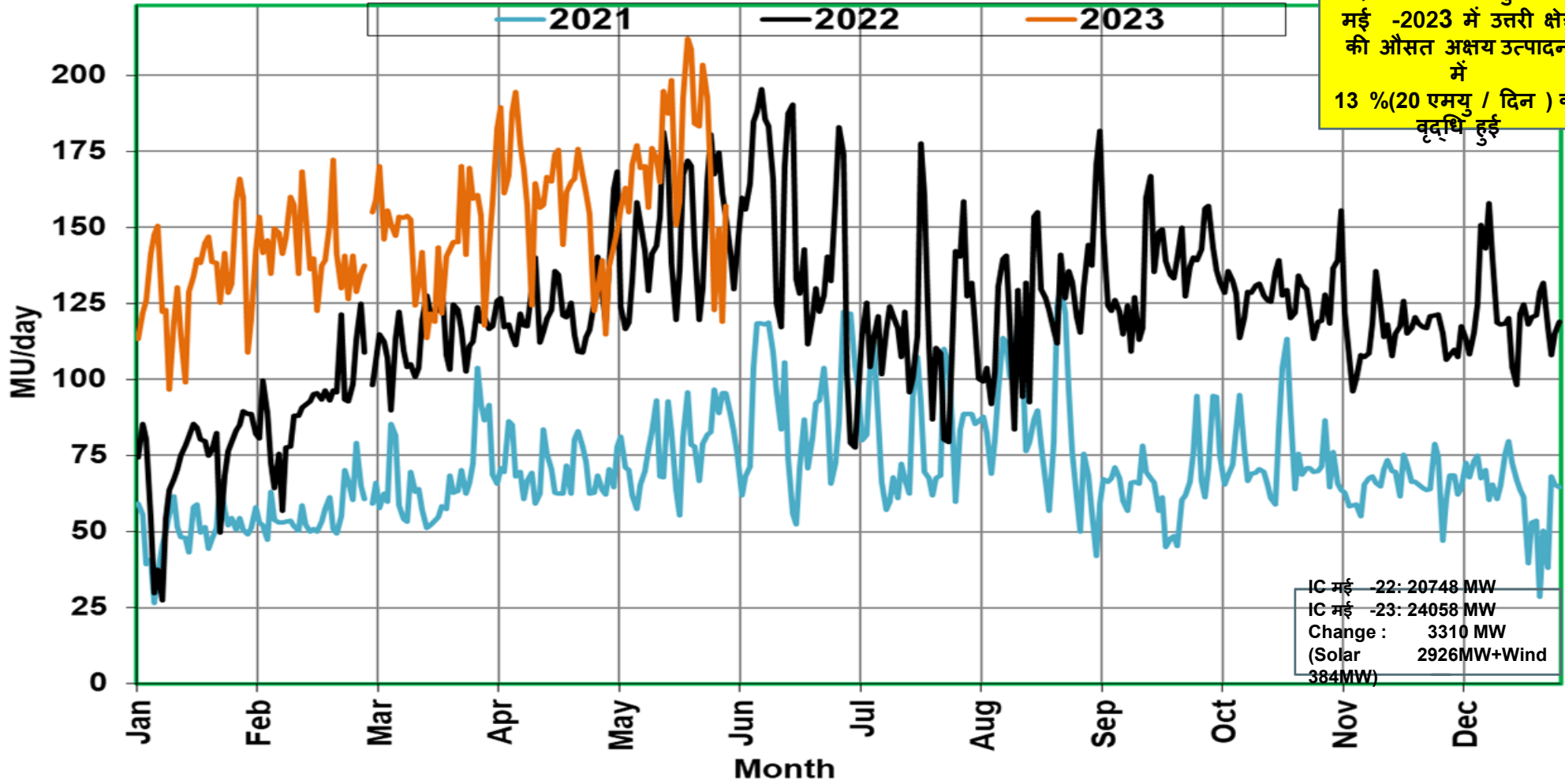

मई -2022 की तुलना में
मई -2023 में उत्तरी क्षेत्र
की औसत अक्षय उत्पादन
में
13 %(20 एमयू / दिन) की
वृद्धि हुई

IC मई -22: 20748 MW
IC मई -23: 24058 MW
Change : 3310 MW
(Solar 2926MW+Wind
384MW)

अंतर-क्षेत्रीय आयात(Mus/Day) की स्थिति

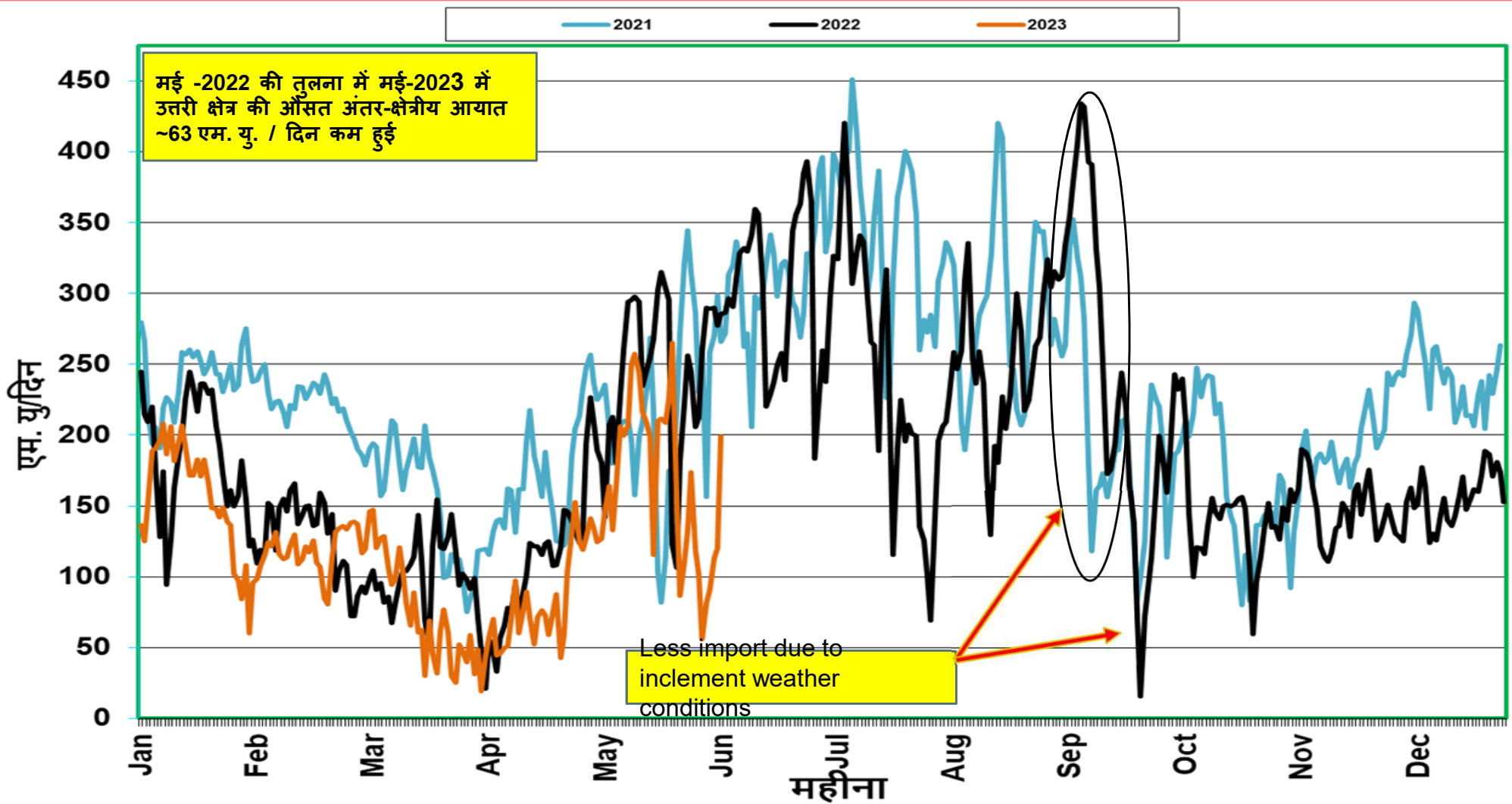

वास्तविक सारांश -
मई -2021 बनाम मई -2022

	मई -2022 (मि.यु. /दिन)	मई -2023 (मि.यु. /दिन)	मई माह में वृद्धि (मि.यु./दिन)
तापीय (Thermal) उत्पादन	749.15	691.88	-57.27
जलीय (Hydro) उत्पादन	249.67	219.31	-30.37
नाभिकीय (Nuclear) उत्पादन	24.35	25.23	0.87
अंतर-क्षेत्रीय (Inter- Regional) कुल आयात	233.93	170.82	-63.11
अक्षय (Renewable) उत्पादन	149.44	169.18	19.74
कुल	1406.5	1276.4	-130.1

RE Penetration

	Maximum Daily MU Penetration			
	May '2023		Record upto April '2023	
	Max % Penetration	Date	Max % Penetration	Date
Punjab	5.02	04-05-2023	12.28	01-04-2020
Rajasthan	34.40	25-05-2023	36.47	22-10-2021
UP	4.05	04-05-2023	4.72	22-03-2023
NR	16.79	26-05-2023	20.69	02-04-2023

	Maximum Instantaneous Penetration in MW			
	May '2023		Record upto April '2023	
	Max % Penetration	Date	Max % Penetration	Date
Punjab	8.38	04-05-2023	26.87	22-04-2020
Rajasthan	61.65	26-05-2023	68.38	31-03-2020
UP	13.84	04-05-2023	17.78	13-02-2023
NR	40.29	03-05-2023	53.72	02-04-2023

Outage Summary For May 2023									
CONSTITUENTS	PLANNED (A)	FORCED OUTAGES (B=C+D)	EMERGENCY SHUTDOWNS (C)	TRIPPING (D)	% PLANNED SHUTDOWNS (A/(A+C))	% EMERGENCY SHUTDOWNS(C/(A+C))	% ESD SHUTDOWNS(C/B)	% TRIPPING (D/B)	TOTAL OUTAGES (A+B)
POWERGRID	187	284	125	159	59.9%	40.1%	44.0%	56.0%	471
UPPTCL	63	170	62	108	50.4%	49.6%	36.5%	63.5%	233
RRVPNL	44	169	50	119	46.8%	53.2%	29.6%	70.4%	213
BBMB	51	71	12	59	81.0%	19.0%	16.9%	83.1%	122
PSTCL	66	40	18	22	78.6%	21.4%	45.0%	55.0%	106
HVPNL	39	53	25	28	60.9%	39.1%	47.2%	52.8%	92
ADANI SOLAR	25	18	1	17	96.2%	3.8%	5.6%	94.4%	43
PTCUL	6	29	3	26	66.7%	33.3%	10.3%	89.7%	35
DTL	0	28	17	11	0.0%	100.0%	60.7%	39.3%	28
NTPC	5	13	2	11	71.4%	28.6%	15.4%	84.6%	18
TATA SOLAR	9	7	3	4	75.0%	25.0%	42.9%	57.1%	16
HPPTCL	7	7	3	4	70.0%	30.0%	42.9%	57.1%	14
PDD JK	2	11	4	7	33.3%	66.7%	36.4%	63.6%	13
SAURYA URJA	0	13	3	10	0.0%	100.0%	23.1%	76.9%	13
FBTL	0	12	3	9	0.0%	100.0%	25.0%	75.0%	12
AZURE	0	12	0	12	0.0%	0.0%	0.0%	100.0%	12
NTPC SOLAR	3	8	2	6	60.0%	40.0%	25.0%	75.0%	11
AVAADA	3	7	4	3	42.9%	57.1%	57.1%	42.9%	10
ATIL	2	7	3	4	40.0%	60.0%	42.9%	57.1%	9
PFTL	0	9	4	5	0.0%	100.0%	44.4%	55.6%	9
EDEN (ERCPL)	6	2	0	2	100.0%	0.0%	0.0%	100.0%	8
PKTSL	8	0	0	0	100.0%	0.0%	0.0%	0.0%	8
POWERLINK	3	3	3	0	50.0%	50.0%	100.0%	0.0%	6
ACME	0	6	4	2	0.0%	100.0%	66.7%	33.3%	6
PAPTL	0	6	1	5	0.0%	100.0%	16.7%	83.3%	6
APCPL	0	5	2	3	0.0%	100.0%	40.0%	60.0%	5
Cleansolar_Jodhpur	1	3	1	2	50.0%	50.0%	33.3%	66.7%	4
NRSS XXIX	3	1	1	0	75.0%	25.0%	100.0%	0.0%	4
RENEW SOLAR	3	1	0	1	100.0%	0.0%	0.0%	100.0%	4
Sekura	1	3	0	3	100.0%	0.0%	0.0%	100.0%	4
MAHINDRA SOLAR	1	2	1	1	50.0%	50.0%	50.0%	50.0%	3
BKTL	0	3	1	2	0.0%	100.0%	33.3%	66.7%	3
ADHPL	2	0	0	0	100.0%	0.0%	0.0%	0.0%	2
THDC	0	2	0	2	0.0%	0.0%	0.0%	100.0%	2
ABC SOLAR	0	1	1	0	0.0%	100.0%	100.0%	0.0%	1
AYAANA	1	0	0	0	100.0%	0.0%	0.0%	0.0%	1
PBTSL	1	0	0	0	100.0%	0.0%	0.0%	0.0%	1
SJVNL	1	0	0	0	100.0%	0.0%	0.0%	0.0%	1
CHANDIGARH	0	1	0	1	0.0%	0.0%	0.0%	100.0%	1
TOTAL	543	1007	359	648	60.19%	39.81%	35.7%	64.3%	1550

OUTAGE SUMMARY OF LAST THREE MONTHS

MONTH	PLANNED	FORCED OUTAGES	EMERGENCY SHUTDOWNS	TRIPPING	% PLANNED as of TOTAL S/D	% EMERGENCY SHUTDOWNS	TOTAL OUTAGES (A+B)
	(A)	(B=C+D)	(C)	(D)	(A/(A+C))	(C/(A+C))	
February-23	939	456	238	218	79.8%	20.2%	1395
March-23	878	545	225	324	79.6%	20.4%	1423
April-23	777	629	267	362	74.4%	25.6%	1406
May-23	543	1007	359	648	60.2%	39.8%	1550

New Elements First Time Charged During May 2023

S. No.	Type of transmission element	Total No
1	400/220kV lines	04
2	ICTs	11
3	FACTS Devices	01
4	Generating Units	01
Total New Elements charged		17



Transmission Lines

S.NO.	LINE NAME	Owner	Length (KM)	Conductor Type	DATE	REMARKS
1	220kV Charor(HP)-Parbati Pooling Banala(PG)-1	HPPTCL	18.2	Twin Moose	10-May-2023	By-pass of 400 kV Kanpur Panki both and 400 kV Kanpur Fatehpur Line 2 through 402 Tie bay CB at 400 kV Kanpur Substation as per Scheme <i>to control Fault Level</i> in Northern Region (Phase-II) deliberated in 1st meeting of National committee of transmission dated 27.07.2018. There is provision to restore the respective system back to original configuration based on status of Main Bay CB (i.e 401 & 403 bay)
2	220kV Charor(HP)-Parbati Pooling Banala(PG)-2	HPPTCL	18.2	Twin Moose	10-May-2023	
3	400kV Panki(UP)-Fatehpur(PG)-1	POWERGRID	113.82 KM	Twin Moose	16-May-2023	
4	400kV Panki(UP)-Fatehpur(PG)-2	POWERGRID	106	Twin Moose	23-May-2023	



ICTs/GTs/Transformers

S.NO.	SUB-STATION	Voltage Level (kV)	CAPACITY (MVA)	ICT NO	DATE
1	Bhakra_L(BB)	220/11	150	1	12-May-2023
2	Bhadla_2 (PG)	400/220/33kV	500 MVA	2	17-May-2023
3	Bhadla(RS)	400/220/33kV	500	3	22-May-2023
4	Moga(PG)	400/220/33kV	500	2	23-May-2023
5	Ludhiana(PG)	400/220/33kV	500	1	24-May-2023
6	TPSL_BKN	220/33	63 MVA	3	25-May-2023
7	TPSL_BKN	220/33	63 MVA	4	25-May-2023
8	TPSL_BKN	33/.415	125kVA	1	26-May-2023
9	Sultanpur(UP)	400/220/33	315 MVA	4	27-May-2023
10	Bhadla_2 (PG)	400/220/33	500	3	30-May-2023

FACTS DEVICES

S.NO.	SUB-STATION	Voltage Level (kV)	CAPACITY (MVAR)	NO	DATE
1	34.5kV, 2 x +/- 150MVAR each Coupling Transformer : 400 KV /34.5 KV, 550MVA MSR : 34.5kV, 125MVAR each MSC : 34.5kV, 2 x 125MVAR each Auxillary Transformer : 630KVA at Bhadla_2 (PG)	400	2 x +/- 150MVAR	1	22-May-2023

Generating Units

SL. NO.	Station name	Owner	Unit No	Capacity (MW)	DATE
1	Bhakra Left Bank Power House (Stage 1) (uprating of existing 108MW unit and connected at Bhakra Right from 220KV side)	BBMB	1	126	21-May-2023

RE Generating Units

SL. NO.	Station name	Owner	Capacity charged	Capacity (MW)	DATE
1	TP Saurya Ltd_Bikaner (PG)	TPSL	110	110	27-May-2023
2	SBSR Power Cleantech Eleven Private Limited_BKN	SBSRPC-11	25	300	31-May-2023



धन्यवाद