



भारत सरकार  
Government of India  
विद्युत मंत्रालय  
Ministry of Power  
उत्तर क्षेत्रीय विद्युत समिति  
Northern Regional Power Committee

दिनांक: 18 सितम्बर, 2024

सेवा में/To,

एनआरपीसी के सभी सदस्य एवं विशेष आमंत्रित (संलग्न सूचीनुसार)  
Members of NRPC & Special Invitees (As per List)

विषय: उत्तर क्षेत्रीय विद्युत समिति की 75 वीं बैठक का कार्यवृत्त।

**Subject: MoM of 75<sup>th</sup> Northern Regional Power Committee (NRPC) -reg**

महोदय/महोदया,

उत्तर क्षेत्रीय विद्युत समिति की 75 वीं बैठक दिनांक 28.08.2024 (सुबह 11:00 बजे) को वीडियो कॉन्फ्रेंसिंग के माध्यम से आयोजित की गयी थी। बैठक का कार्यवृत्त संलग्न है। यह उ.क्षे.वि.स. की वेबसाइट (<http://164.100.60.165/>) पर भी उपलब्ध है।

The 75<sup>th</sup> meeting of Northern Regional Power Committee (NRPC) was held on 28.08.2024 (11:00AM) via video conferencing. MoM of the same is attached herewith. The same is also available on NRPC Sectt. Website (<http://164.100.60.165/>).

भवदीय

Yours faithfully

Signed by Vijay Kumar  
Singh

Date: 18-09-2024 13:06:01

(वी.के. सिंह)

(V.K. Singh)

सदस्य सचिव

Member Secretary

प्रतिलिपि: Chairperson, NRPC & MD, HPPTCL ([md.tcl@hpmail.in](mailto:md.tcl@hpmail.in))

75<sup>th</sup> NRPC Meeting (28 August 2024)-MoM



**उत्तर क्षेत्रीय विद्युत समिति**  
**NORTHERN REGIONAL POWER COMMITTEE**



**Minutes of**  
**The 75<sup>th</sup> meeting of**  
**Northern Regional Power Committee**

**Date: 28<sup>th</sup> August 2024**

**Time: 11:00 AM**

**Via Video Conferencing**

75<sup>th</sup> NRPC Meeting (28 August 2024)-MoM

## Contents

<b>A.1</b>	<b>Approval of MoM of the 50<sup>th</sup> TCC &amp; 74<sup>th</sup> NRPC meeting.....</b>	<b>3</b>
<b>A.2</b>	<b>Status of action taken on decisions of 50<sup>th</sup> TCC &amp; 74<sup>th</sup> NRPC meeting (agenda NRPC Secretariat).....</b>	<b>4</b>
<b>A.3</b>	<b>VOIP Communication system for Grid-Operation for all Five Regions NR, NER, SR, WR, ER as PAN India (agenda by CTUIL).....</b>	<b>4</b>
<b>A.4</b>	<b>Procedure for approval of Protection Settings by NRPC (agenda by NRPC Secretariat).....</b>	<b>9</b>
<b>A.5</b>	<b>Availability certification of outage caused by grid incident/disturbance not attributable to the transmission licensee for the months of May, June and July 2024 (agenda by NRPC Secretariat).....</b>	<b>10</b>
<b>A.6</b>	<b>Submission of self-audit report in compliance to IEGC regulation 56(2) (agenda by NRLDC).....</b>	<b>16</b>
<b>A.7</b>	<b>Continuous high frequency operation of grid on 03.08.2024, 04.08.2024 &amp; 11.08.2024 (agenda by NRLDC).....</b>	<b>17</b>
<b>A.8</b>	<b>Expediting commissioning of Sikar-II transmission system (agenda by NRLDC)</b>	<b>23</b>
<b>A.9</b>	<b>Recommendations of the committee to analyse the grid event happened at 13:53 hrs on 17<sup>th</sup> June 2024 due to tripping of HVDC Champa-Kurukshetra (agenda by NRPC Secretariat).....</b>	<b>26</b>
<b>A.10</b>	<b>Reimbursement of medical bills submitted by Shri Sunny Mann, Lower Division Clerk, working in NRPC Secretariat (agenda buy NRPC Secretariat).....</b>	<b>30</b>
<b>A.11</b>	<b>Status of Expenditure During Quarter-1 of FY 2024-25 from NRPC Fund (agenda by NRPC Secretariat).....</b>	<b>32</b>
<b>A.12</b>	<b>Outstanding Contribution for FY 2024-25 (agenda by NRPC Secretariat).....</b>	<b>33</b>
<b>A.13</b>	<b>Inclusion of RE generators having more than 1000 MW installed capacity as permanent members of NRPC (agenda by NRPC Secretariat).....</b>	<b>34</b>
<b>A.14</b>	<b>Non-member participants in NRPC (agenda by NRPC Secretariat).....</b>	<b>36</b>
<b>A.15</b>	<b>Amendment in Conduct of Business Rules (COBR) of NRPC to include MNRE, SECI etc. as members in RE Sub-Committee (agenda by NRPC Secretariat).....</b>	<b>37</b>
<b>A.16</b>	<b>Hiring of Manpower in NRPC secretariat through GeM Portal under Manpower Outsourcing Services - Minimum Wages Contract for various categories (agenda by NRPC Secretariat).....</b>	<b>38</b>
<b>A.17</b>	<b>Proposal for conducting TCC meeting also NRPC meeting on the same VC link in future (agenda by NRPC Secretariat).....</b>	<b>39</b>

75<sup>th</sup> NRPC Meeting (28 August 2024)-MoM

**उत्तरी क्षेत्रीय विद्युत समिति की 75<sup>वीं</sup> बैठक का कार्यवृत्त**  
**Minutes of Meeting of 75<sup>th</sup> NRPC Meeting**

Member Secretary, NRPC welcomed the Chairperson, NRPC and MD, HPPTCL. Further, he welcomed all the participants connected through VC in the meeting from power utilities of Northern Region.

Chairperson, NRPC and MD, HPPTCL welcomed all participants connected in the meeting. List of participants is attached as **Annexure-P**.

### **A.1 Approval of MoM of the 50<sup>th</sup> TCC & 74<sup>th</sup> NRPC meeting**

- A.1.1 EE (P), NRPC apprised that the minutes of the 50<sup>th</sup> TCC & 74<sup>th</sup> NRPC meeting (held on 28-29.06.2024) were issued vide letter dtd. 30.07.2024. Comment received from HPSLDC was discussed and Forum approved the MoM with inclusion of HPSLDC comment.

#### **Decision of forum:**

*Forum approved the issued MoM with following amendment:*

Agenda of issued MOM	Text as per Issued minutes of 50 <sup>th</sup> TCC & 74 <sup>th</sup> NRPC	Amended Text
Actions for improvement in grid operation (State wise) (agenda by NRLDC)	<b>A.6.21 – (Fifth bullet point)</b> HP SLDC representative informed that CBIP has been engaged for carrying out third party protection audit of 220/132kV Kunihar substation. It is expected to be carried out within next one month.	<b>A.6.21 - (Fifth bullet point)</b> HP SLDC representative informed that HPSEBL has intimated that to carry out protection audit of 220kV Substation, Kunihar and Baddi the budgetary offer has been received from M/s CBIP and the protection audit shall be carried out within one month.

### **A.2 Status of action taken on decisions of 50<sup>th</sup> TCC & 74<sup>th</sup> NRPC meeting (agenda NRPC Secretariat)**



75<sup>th</sup> NRPC Meeting (28 August 2024)-MoM

- A.2.1 MS, NRPC conveyed that the agenda has been taken to track the status of action taken as per decision of previous meetings. So that, issues may be resolved at the earliest.
- A.2.2 Concerned utilities submitted the status of action taken.
- A.2.3 Forum noted the action taken status reported by concerned utilities and requested utilities to expedite the actions.

**Decision of Forum**

*Forum noted action taken status as attached as **Annexure- I**.*

**A.3 VOIP Communication system for Grid-Operation for all Five Regions NR, NER, SR, WR, ER as PAN India (agenda by CTUIL)**

- A.3.1 CTUIL apprised that Hot Line Speech Communication System (VOIP based PABX system) was implemented in 2016 by POWERGRID in all five regions after grid disturbance in 2012 where grid operators faced problem of fast communication due to unavailability of dedicated speech communication PAN India between NLDC, RLDCs, SLDCs, important state and ISTS substations and generators. The said PABX was implemented by M/s Orange through Alcatel Lucent as OEM. The lead region for the existing VoIP system is Northern Region of POWERGRID. After execution of the project cost of the same booked under regional communication schemes. As per CERC tariff regulations useful life of system is 15 years.
- A.3.2 In the 67<sup>th</sup> NRPC meeting dtd. 30.06.2023, POWERGRID representative stated that the scheme executed by M/s ORANGE was with a provision of AMC of 7 years as part of the contract and the same is expiring in July' 2023 for most of the sites.
- A.3.3 AMC of the same was extended and approved in the 67<sup>th</sup> NRPC for further 2 years upto July'25 with financial implication and shall be booked under ULDC O&M charges as per the CERC norms. After July'25 there is no support shall be extended by Alcatel (OEM). POWERGRID stated they are not able to maintain the system beyond that AMC expiration. MS-NRPC advised CTU to plan upgradation/ new system in view of expiration of AMC in July'25.

75<sup>th</sup> NRPC Meeting (28 August 2024)-MoM

- A.3.4 Grid-India in 23<sup>rd</sup> NRPC- TeST meeting (held on dtd. 21.09.2023) stated that VOIP system is utmost requirement of Grid-Operation and shall be planned by CTU in advance as there is no support of OEM after July'25.
- A.3.5 During 24<sup>th</sup> TeST Meeting of NRPC held on 09.02.24, it was agreed in Forum that Hot Line exchange should be considered as part of communication system and CTU shall take up scheme in all RPCs for approval and then in the NCT.
- A.3.6 In this regards CTU discussed the requirements with utilities & various VOIP system suppliers/OEMs and acquired inputs from the utilities in the various meetings of CPM, COM/TeST/SCADA of all five regions (reference are given in the scheme). For the utilities those have provided inputs we have considered the same in the cost estimate purpose. Further a combined CPM (Communication planning meeting) of all five region was also held on 12.06.2024 to obtain uniformity of features and functions of the VoIP system among all regions. After incorporating the comments of all utilities MoM is issued same is attached at **Annexure-II**.
- A.3.7 CTUIL has mentioned that the tentative cost estimate is based on the budgetary quotation/s obtained from three nos. of prospective OEMs.
- A.3.8 CTUIL proposed that being a Nationwide PAN India project, the total cost of five regions including NLDC and international Exchange (Cross border links) VoIP system shall be put up in all five regions for RPC/s review followed by NCT approval as single Scheme and package PAN India Basis for seamless integration.
- A.3.9 CTUIL submitted that tentative Region-wise cost breakup of the scheme is as below:

**Cost Breakup Between Regions and Central Sector and State Sector**

Region	Central Sector (ISTS) (in Crs.)	State Sector (in Crs.)	Total (in Crs.)
NR	₹18.54	₹15.92	₹ 34.46
SR	₹15.3	₹ 12.68	₹ 27.98
WR	₹14.61	₹ 11.74	₹ 26.35

75<sup>th</sup> NRPC Meeting (28 August 2024)-MoM

ER	₹12.32	₹ 7.44	₹ 19.76
NER	₹16.91	₹5.45	₹ 22.36
National Portion (NLDC Ex, International exchange and Cyber audit)	₹ 6.55	₹ 0	₹ 6.55

**Grand Total: ₹137.46 Cr excluding GST/TAXES**

***(Including 6 year of AMC after completion of 1 yr warranty period)***

A.3.10 There are three types of cost involved, Regional Central Sector, National Central Sector, State Sector. The sharing of cost shall be done as per following mechanism between constituents:

- (i) Regional Central Sector Cost to be shared by respective region DICs as per CERC (Sharing of Inter-State Transmission Charges and Losses) Regulations, 2020 under Regional Component.
- (ii) National Central Sector Cost to be shared by all regional DICs as per CERC (Sharing of Inter-State Transmission Charges and Losses) Regulations, 2020 under National Component.
- (iii) State Sector Cost shall be shared by respective state/s for their portion as per CERC (Sharing of Inter-State Transmission Charges and Losses) Regulations, 2020.
- (iv) AMC for State Sector shall be shared by respective states for their portion as per CERC (Sharing of Inter-State Transmission Charges and Losses) Regulations, 2020.

A.3.11 CTUIL submitted the details of proposed scheme as **Annexure-III**.

A.3.12 CTUIL representative informed that the scheme has already been approved in the SRPC and WRPC meetings.

A.3.13 CGM, NRLDC asked the reason for higher cost of Northern region in comparison to the other region. CTUIL representative replied that in Northern region 9 no. of states are covered which led to higher cost due to more number of equipment.

*75<sup>th</sup> NRPC Meeting (28 August 2024)-MoM*

- A.3.14 GM, POWERGRID raised the concern regarding implementation timeframe mentioned in the proposed scheme. He conveyed that implementation timeframe should be 24 months as also agreed in the WRPC meeting.
- A.3.15 CTUIL representative highlighted that in WRPC meeting, the implementation timeframe was agreed as 24 months because there shall be necessary arrangements for VOIP connectivity till this scheme gets implemented. In the same line, he requested POWERGRID to do some arrangements before the implementation of this proposed scheme.
- A.3.16 POWERGRID representative replied that POWERGRID will try to further extend the AMC of M/s Orange after discussion with them.
- A.3.17 MS, NRPC informed that timeframe was agreed as 24 months in the WRPC meeting. He asked POWERGRID regarding status of filing of the petition in CERC for earlier project of VOIP for wrapping it in 7 years instead of 15 years.
- A.3.18 POWERGRID representative updated that petition is yet to be filed. He informed that POWERGRID is working on O&M Audited Cost Certificates to be filed with petition.
- A.3.19 Subsequently, CTUIL asked POWERGRID to convey its concurrence for this new scheme while wrapping of the earlier VOIP project in 7 years instead of 15 years. As per CERC tariff regulations useful life of system is 15 years.
- A.3.20 MS, NRPC directed POWERGRID to convey the status of filing petition through a letter to CTU.
- A.3.21 CGM, NRLDC also requested POWERGRID to arrange extension of AMC of M/s Orange to have continuous VOIP system.
- A.3.22 DGM, NRLDC conveyed that scope of scheme shall be such that, the architecture may be changed by implementing agency suitably, based on requirement. Forum agreed for the same.
- A.3.23 Rajasthan SLDC representative also raised the concern regarding the payment of AMC. It was highlighted that uniformity in the scheme will be maintained if AMC of all states is done under central sector. This will increase the usefulness of the system. Otherwise, any state who is not going to have AMC for particular period, may create hurdle for smooth communication.
- A.3.24 POWERGRID representative highlighted that there is no issue to implement the scheme in the same manner of earlier scheme under the center sector. AMC of states may be made part of Central Sector similar to previous scheme. Central Sector/ PoC tariff are also born by states only.

75<sup>th</sup> NRPC Meeting (28 August 2024)-MoM

- A.3.25 Further, UPSLDC representative raised the queries regarding the scheme. He questioned that why server is needed for all SLDCs. Why it cannot be done on main and backup servers.
- A.3.26 MS, NRPC conveyed that all who are having issues regarding AMC and query regarding the scheme, may send in writing to CTUIL and NRPC Secretariat. Further, the agenda is yet to be deliberated in the ERPC, NERPC and NPC meetings. Meanwhile POWERGRID may explore the arrangements for un-interrupted communications system and accordingly implementation timeframe may be finalized in NPC meeting.
- A.3.27 The issues of states of all regions and POWERGRID regarding AMC will be deliberated in the upcoming NPC meeting. MS, NRPC directed CTUIL to bring this agenda in the upcoming NPC meeting.

**Decision of Forum**

*Forum accorded the technical approval for the proposal of CTUIL for the scope of Northern Region. POWERGRID may explore for continuous AMC till implementation of new scheme. Implementation timeframe, and issues of states may be deliberated in the upcoming NPC meeting.*

**A.4 Procedure for approval of Protection Settings by NRPC (agenda by NRPC Secretariat)**

- A.4.1 EE (P), NRPC apprised that as per clause 14 (2) of IEGC 2023:  
*All users connected to the grid shall:*
- i. obtain approval of the concerned RPC for (i) any revision in settings, and (ii) implementation of new protection system;*
  - ii. intimate to the concerned RPC about the changes implemented in protection system or protection settings within a fortnight of such changes;*
- A.4.2 Accordingly, in 49<sup>th</sup> PSC meeting (held on 25.01.2024), procedure for approval of protection settings was deliberated and approved.
- A.4.3 Further, the agenda was again discussed in 50<sup>th</sup> PSC meeting (held on 29.05.2024), wherein the procedure was revised (attached as **Annexure-IV**).
- A.4.4 The same was listed as agenda in the 50<sup>th</sup> TCC and 74<sup>th</sup> NRPC meeting. However, NRLDC raised concerns regarding the approved procedure and desired to get it deliberated again in the upcoming PSC meeting.

*75<sup>th</sup> NRPC Meeting (28 August 2024)-MoM*

- A.4.5 In view of above, the procedure for approval of protection settings was deliberated in the 51<sup>st</sup> PSC meeting (held on 12.07.2024) and approved. The same is attached as **Annexure-V**.
- A.4.6 In the meeting, NRLDC raised the concern on approved procedure of 51<sup>st</sup> PSC meeting. CGM, NRLDC mentioned that NRLDC may provide only provisional approval for the protection settings of ISTS elements during FTC. Further, after receiving the provisional approval of the protection settings, utility may implement settings but utility shall list an agenda in the upcoming Protection Sub-Committee for final approval of the same. Forum agreed for the same.
- A.4.7 Subsequently, EE (P), NRPC asked the views of SLDCs to align the protection settings approval procedure as above for the intrastate elements too.
- A.4.8 HPSLDC representative highlighted that protection experts are not available at HPSLDC. Therefore, HPSLDC gives consent on the proposed settings of HPPTCL and accords FTC. He requested Forum to arrange training modules and programs regarding protection domain including settings.
- A.4.9 UKSLDC representative also mentioned that protection experts are not available at UKSLDC. He mentioned that a joint committee of SLDC and STU may be formed. Forum guided UKSLDC to have an internal committee with its STU if required.
- A.4.10 SE (O), NRPC highlighted that as per IEGC, 2023 protection settings are to be approved by RPCs. Therefore, NRLDC/SLDCs may give provisional approval during FTC and final approval may be given by Protection Sub-Committee.
- A.4.11 In view of above, MS, NRPC conveyed that NRLDC/SLDCs may provide provisional approval for the of ISTS/intrastate elements (as applicable) during FTC. Further, after receiving the provisional approval of the protection settings, utility shall implement provisional settings and shall list an agenda in the upcoming Protection Sub-Committee for final approval of the same. Forum agreed for the same.
- A.4.12 Accordingly, the finalized procedure for approval of protection setting is attached as **Annexure-VI**.

***Decision of Forum***

*Forum finalized the procedure for approval of protection setting as **Annexure-VI**. Utilities were requested for compliance of same.*

75<sup>th</sup> NRPC Meeting (28 August 2024)-MoM

**A.5 Availability certification of outage caused by grid incident/disturbance not attributable to the transmission licensee for the months of May, June and July 2024 (agenda by NRPC Secretariat)**

A.5.1 EE (P), NRPC apprised that the following outages of POWERGRID are under consideration:

Sr no	Line	Outage from	Outage upto	Reason
1	220KV FGPP-FARIDABAD(Sec-58)-I	01.05.2024 00:00 Hrs.	30.07.2024 17:30 Hrs.	<p>CB emergency hand tripped by HVPNL due to R-Phase cable box damaged at Faridabad Sec-58(HVPNL end).</p> <p>Line has been out since <a href="#">20-01-2024 04:02</a> hrs.</p> <p>Line anti-theft charged at 17:00 Hrs on 15.03.2024 from FGPP(NTPC) end.</p> <p>Further, LILO arrangement (FGPP-to- Sec-58 ckt-1 &amp; samaypur -sec-58 ckt-1) has been made direct at 17:30 Hrs. on 30.07.2024. (for implementing the said direct arrangement, HVPNL took shutdown of the 220KV FARIDABAD(Sec-58)-SPUR-I from 28.07.2024 (10:12 Hrs.) to 30.07.2024 (17:30Hrs.).</p>
2	400 KV KISHENPUR-	23.06.2024 12:53	24.07.2024 15:27	SD taken by JKPTCL due to sinking of Tower of in LILO

75<sup>th</sup> NRPC Meeting (28 August 2024)-MoM

	BAGLIHAR-III	Hrs.	Hrs.	portion of the Line owned by JKPTCL.
3	400 KV BAGLIHAR-NEW WANPOH-1	23.06.202 4 12:57 Hrs.	24.07.202 4 15:19 Hrs.	Emergency shutdown as safety purpose as this line is crossing below 220kV Kishenpur - Mirbazar Ckt whose tower is fully damaged due to the landslide occurred at Tower Loc. no. KP-196 at Peerah and tower is on the verge of collapse adjoining to 400KV Tower. Restoration of Tower is done by JKPTCL.

**Regarding S.No.1:**

- A.5.2 He added that Licensee POWERGRID vide mail dated 06.08.2024 submitted that a meeting was held on 03.06.2024 to discuss HVPN proposal to connect 220kV BBMB Samaypur Ckt-1 to 220kV FGPP Ckt-1 directly instead of existing LILO arrangement due to long outage of 8 to 10 month in restoration of sec-58 GIS station of HVPNL.
- A.5.3 Further, LILO arrangement (FGPP-to- Sec-58 ckt-1 & samaypur -sec-58 ckt-1) has been made direct at 17:30 Hrs. on 30.07.2024 as per the decision of the above-mentioned meeting dated 03.06.2024. (Minutes are attached as **Annexure-VII**).
- A.5.4 EE (P), NRPC informed that availability for the above line from its original outage (20.01.2024) to March, 2024 end has been considered under outage caused by grid incident/disturbance not attributable to the transmission licensee as per the prevailed Central Electricity Regulatory Commission (Terms and Conditions of Tariff) Regulations, 2019.
- A.5.5 Further, he added that the availability for the above line for its outage of April 2024 has been considered under outage caused by grid incident/disturbance not attributable to the transmission licensee as per the extant Central Electricity Regulatory Commission (Terms and Conditions of Tariff) Regulations, 2024 as the duration of upto 01 month can be allowed by MS, NRPC.



*75<sup>th</sup> NRPC Meeting (28 August 2024)-MoM*

- A.5.6 As the outage is going beyond 01 month after the applicability of Central Electricity Regulatory Commission (Terms and Conditions of Tariff) Regulations, 2024, approval of NRPC forum is required for consideration of outage caused by grid incident/disturbance not attributable to the transmission licensee as per Appendix-IV of the said regulation.
- A.5.7 Haryana SLDC representative conveyed that the outage period may be deemed to licensee as POWERGRID has no fault at their end and delay is due to supply of equipment from foreign country. Further, he updated Forum that actual arrangement will take time. Therefore, this bypass arrangement may be continued.
- A.5.8 POWERGRID representative submitted that both ends of 220KV FGPP-FARIDABAD(Sec-58)-I line belong to other utilities which causes delay in reporting of outage of line. In this regard, POWERGRID vide mail dated 27.08.2024 sent the previous mail communication done for timely intimation about any outage. Further, he mentioned that there is no fault of POWERGRID in this outage and based on the decision of meeting held on 03.06.2024, bypass arrangement had been done after taking necessary approvals.
- A.5.9 Apart from this, line was antitheft charged at 17:00hrs on 15.03.2024 from FGPP(NTPC) end. In this way, line was always available.
- A.5.10 In view of above, he requested Forum to consider that line was not under outage.
- A.5.11 AEE (P), NRPC informed that POWERGRID on 27.8.2024, forwarded the mail communications of HVPN and POWERGRID mentioning that at 3:19 Hrs., 220kV Sec-58 to FGPP Ckt-1<sup>st</sup> got tripped, observed heavy sound and smoke in GIS building at Sec-58 substation and on checking 220kV R-phase, the Cable termination kit was found damaged.
- A.5.12 MS, NRPC highlighted that the delay in revival of line is mainly due to non-availability of GIS equipment for Haryana Substation. Therefore, bypass arrangement has been done. Further, He supported that there was no fault of POWERGRID. In view of this, outage of 220KV FGPP-FARIDABAD(Sec-58)-I line from 20.01.2024 to 30.04.2024 has already been considered under outage caused by grid incident/disturbance not attributable to the transmission licensee.
- A.5.13 Further, MS, NRPC conveyed that the outage period has gone beyond the three months after the applicability of Central Electricity Regulatory Commission (Terms and Conditions of Tariff) Regulations, 2024. In view of above, he suggested POWEGRID to approach Honorable CERC.

75<sup>th</sup> NRPC Meeting (28 August 2024)-MoM

A.5.14 Forum agreed with the availability certification done by NRPC Secretariat for the period up to April 2024 month. Further, Forum directed POWERGRID to approach the Honorable CERC for decision on availability of outage period after April 2024.

**Regarding S.No. 2 & 3:**

A.5.15 NRLDC has already verified outage period and reason during the verification of availability data for June, 2024 month.

A.5.16 In view of above, availability for the above outages for the month June, 2024 has been considered under outage caused by grid incident/disturbance not attributable to the transmission licensee as per the extant Central Electricity Regulatory Commission (Terms and Conditions of Tariff) Regulations, 2024 as the duration of upto 01 month can be allowed by MS, NRPC.

A.5.17 As the outages are going beyond 01 month after the applicability of Central Electricity Regulatory Commission (Terms and Conditions of Tariff) Regulations, 2024, approval of NRPC forum is required for consideration of outage caused by grid incident/disturbance not attributable to the transmission licensee as per Appendix-IV of CERC (Terms & Conditions of Tariff) Regulation 2024, mentioned below:

*5. For the following contingencies, the outage period of transmission elements, as certified by the Member Secretary, RPC, shall be excluded from the total time of the element under the period of consideration for the following contingencies:*

*i).....*

*ii) Outage caused by grid incident/disturbance not attributable to the transmission licensee, e.g. faults in a substation or bays owned by another agency causing an outage of the transmission licensee's elements, and tripping of lines, ICTs, HVDC, etc., due to grid disturbance. However, if the element is not restored on receipt of direction from RLDC while normalizing the system following grid incident/disturbance within reasonable time, the element will be considered not available for the period of outage after issuance of RLDC's direction for restoration;*

75<sup>th</sup> NRPC Meeting (28 August 2024)-MoM

iii) *The outage period which can be excluded for the purpose of sub-clause (i) and (ii) of this clause shall be declared as under:*

- i. *Maximum up to one month by the Member Secretary, RPC;*
- ii. ***Beyond one month and up to three months after the decision at RPC;***
- iii. *Beyond three months by the Commission for which the transmission license shall approach the Commission along with reasons and steps taken to mitigate the outage and restoration timeline.*

*\*As per corrigendum of Central Electricity Regulatory Commission (Terms and Conditions of Tariff) Regulations, 2024 issued on 09.04.2024, Sub-Clause No. (4) and (5) shall be read as Sub-Clause (5) and Sub-Clause (6) of Appendix-IV, respectively.*

A.5.18 For the event mentioned at serial no. 2 & 3, SE, JKPTCL stated that JKTPCL took shutdown of 400kV Kishenpur-Baglihar-III and 400kV Baglihar-New Wanpoh-1 for temporary restoration (via bypassing tower no. 195 & 196 and directly connecting tower no. 195 to tower no. 198) of JKPTCL's 220kV line whose tower was damaged due to the landslide.

A.5.19 Forum was of view that the outage mentioned at serial no. 2 & 3 may be considered as outage caused by grid incident/disturbance not attributable to the transmission licensee as JKPTCL's tower damage has caused outage of POWERGRID's lines.

### **Decision of Forum**

*After detailed deliberation Forum decided the followings-*

- a. *For event at Sr. No. 1 – Forum directed POWERGRID to approach the Honorable CERC for decision on availability of outage period after April 2024.*
- b. *Forum decided to consider the outage of 220KV FARIDABAD(Sec-58)-SPUR-I from 28.07.2024 (10:12 Hrs.) to 30.07.2024 (17:30Hrs.) under outage caused by grid incident/disturbance not attributable to the transmission licensee as it outage was required for bypass of LILO and making direct arrangement as decided in meeting dated 03.06.2024.*
- c. *For event at Sr. No. 2 – Forum decided to consider the outage of 400kV Kishenpur-Baglihar-III from 23.06.2024 (12:53 Hrs.) to 24.07.2024 (15:27 Hrs.) under outage caused by grid incident/disturbance not attributable to the transmission licensee.*

75<sup>th</sup> NRPC Meeting (28 August 2024)-MoM

d. For event at Sr. No. 3 – Forum decided to consider the outage of 400kV Baglihar-New Wanpoh-1 from 23.06.2024 (12:57 Hrs.) to 24.07.2024 (15:19 Hrs.) under outage caused by grid incident/disturbance not attributable to the transmission licensee.

## A.6 Submission of self-audit report in compliance to IEGC regulation 56(2) (agenda by NRLDC)

A.6.1 NRLDC representative stated that as per IEGC regulation 56(2), self-audit shall be conducted for compliance of these regulations and reports shall be submitted by the users to concerned RLDC by 31st July 2024. IEGC clause were quoted in the meeting:

Quote

“ (2) Self –Audit:

(a) All users, CTU, STUs, NLDC, RLDCs, RPCs and SLDCs, power exchanges, QCAs, SNAs shall conduct annual self-audits to review compliance of these regulations and submit the reports by 31<sup>st</sup> July of every year.

(b) The self-audit report shall inter alia contain the following information with respect to non-compliance:

- (i) Sufficient information to understand how and why the non-compliance occurred;
- (ii) Extent of damage caused by such non-compliance;
- (iii) Steps and timeline planned to rectify the same;
- (iv) Steps taken to mitigate any future recurrence;

(c) The self-audit reports by users, QCAs, SNAs shall be submitted to the concerned RLDC or SLDC, as the case may be.”

Unquote

A.6.2 All ISGS, IPPs and transmission licensees were requested to kindly conduct the self-audit and submit their self-audit report to NRLDC. List is attached as **Annexure-VIII** and was also presented in the meeting.

A.6.3 NHPC and POWERGRID representative requested that checklists/ format may be provided from NRLDC/NRPC side for submission of self-audit report by different utilities.

A.6.4 ED, NRLDC stated that NRLDC has carried out self-audit based on identification of compliances to be met as per IEGC 2023 and accordingly submitted to CERC. The

75<sup>th</sup> NRPC Meeting (28 August 2024)-MoM

quoted clause mentions only self-audit therefore utilities need to themselves identify the points applicable to them and submit self-audit reports.

- A.6.5 MS, NRPC stated that all users need to carry out self-audit as per IEGC. It was further mentioned that preparation of common format would delay the self-audit process. Self-audit serves as tool for users to identify the areas for improvement and it is best that each utility carries this out independently and utilities may make their own format. It was mentioned that since NRLDC would be receiving self-audit reports from all utilities, best practices of one utility may also be shared with others by NRLDC/ utility.
- A.6.6 Chairperson NRPC and MD, HPPTCL asked NRPC forum to finalize a timeline for submission of self-audit reports to NRLDC.
- A.6.7 Forum decided that concerned utilities may submit self-audit reports by 31<sup>st</sup> October 2024 for previous F.Y. to NRLDC as 31<sup>st</sup> July has already passed.

***Decision of Forum***

*All utilities were asked to conduct the self-audit and submit their self-audit report to concerned agencies mentioned in IEGC 2023 latest by 31<sup>st</sup> October 2024 for F.Y. 2023-24.*

**A.7 Continuous high frequency operation of grid on 03.08.2024, 04.08.2024 & 11.08.2024 (agenda by NRLDC)**

- A.7.1 NRLDC representative apprised that on 03.08.2024, 04.08.2024 & 11.08.2024, continuously high frequencies were observed in the grid. On these days some of the states in NR were found to under drawing to the tune of 1000MW contributing to the high frequency operation.

Frequency profile of 03.08.2024 and 04.08.2024

### 75<sup>th</sup> NRPC Meeting (28 August 2024)-MoM

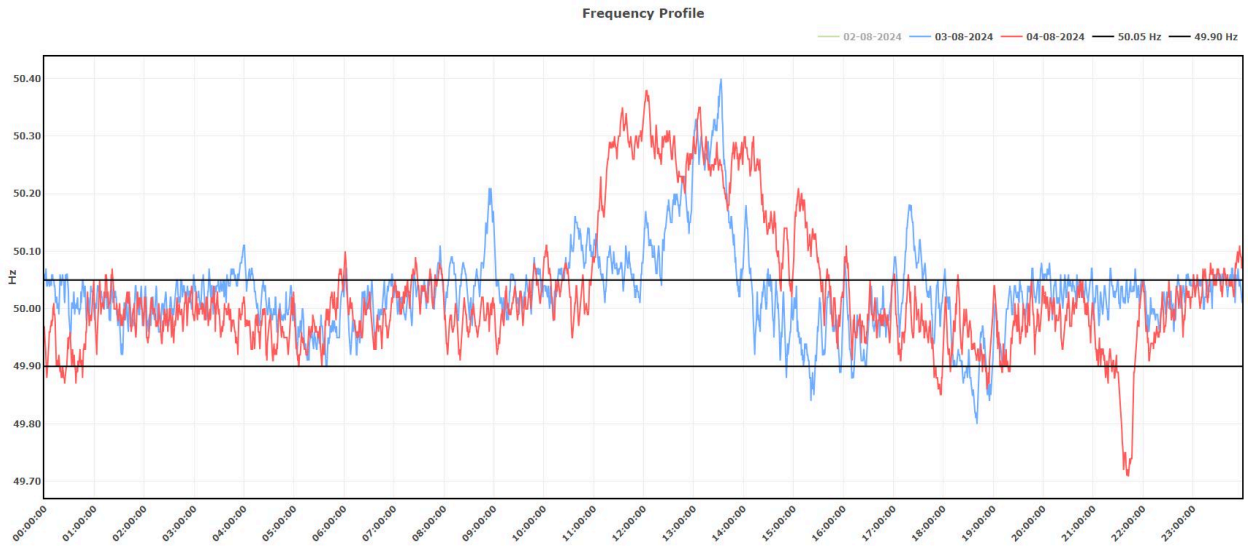

Frequency profile of 11.08.2024

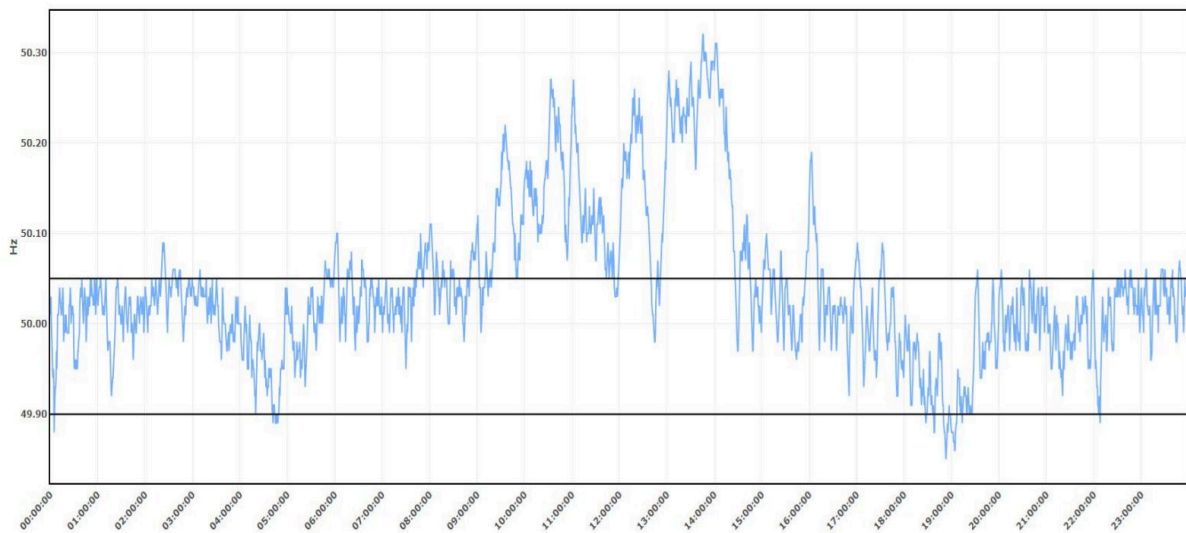

Frequency profile of 25.08.2024

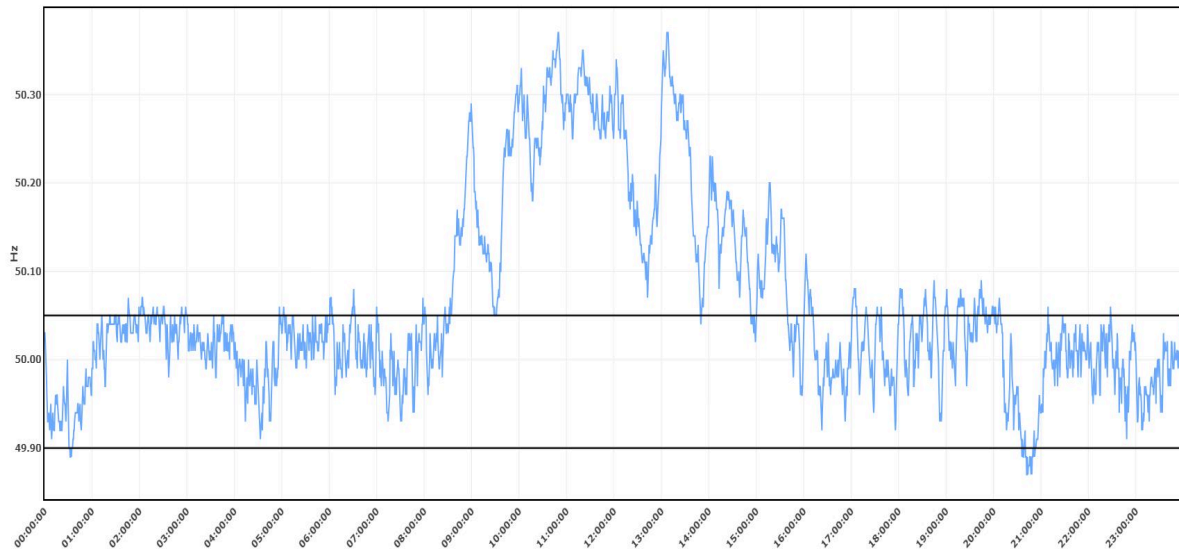
75<sup>th</sup> NRPC Meeting (28 August 2024)-MoM

A.7.2 NRLDC representative reiterated that Central Electricity Authority (Flexible Operation of Coal based Thermal Power Generating Units) Regulations, 2023 notified in January 2023 mentions that:

*Quote*

***“6. Minimum power level capabilities of coal based thermal power generating units for flexible operation.-***

*The coal based thermal power generating units shall have flexible operation capability with minimum power level of forty percent.*

*Provided that the generating units which are not capable of achieving minimum power level of fifty-five percent, shall achieve the same within one year of the notification of these regulations.*

*Provided further that the generating units which are not capable of achieving minimum power level of forty percent, shall achieve the same as per phasing plan mentioned in the sub-regulation (2) of regulation 5 of these regulations.”*

*Unquote*

A.7.3 From the trends available at NRLDC, it was seen that intrastate thermal generation of some NR states was not backed down to 55% of MCR. It was around 78% of MCR on 03.08.2024 and only around 75% of MCR on 04.08.2024. To facilitate further integration of RE generation especially during lower demand period, it is suggested that intrastate thermal generators may be asked to back down further so as to maintain grid frequency and also avoid huge under drawl by state.

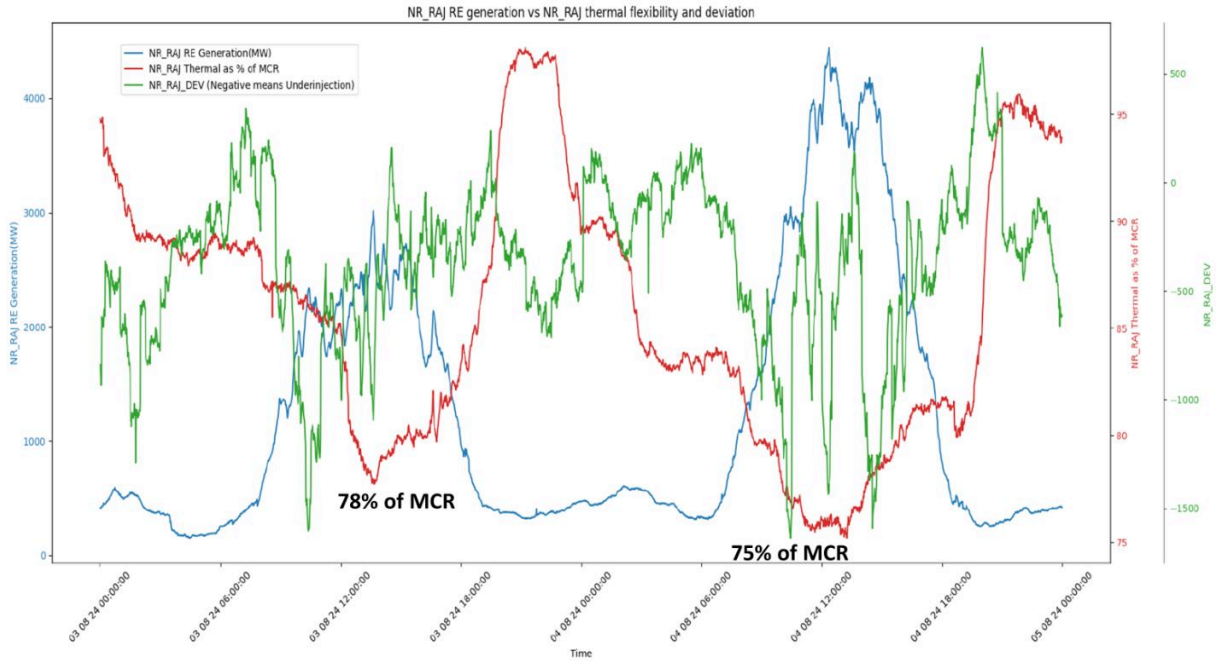
75<sup>th</sup> NRPC Meeting (28 August 2024)-MoM

A.7.4 It was mentioned that the problem gets aggravated if number of intrastate thermal generating units are not providing the necessary technical minimum support. It was mentioned that at All India level, for ISGS thermal generation the ratio of minimum to maximum generation was around 56% whereas for intrastate thermal generation, the ratio of minimum to maximum generation was around 76% which is way higher than standards specified by CEA for flexible operation of thermal plants.

### All India Thermal Flexing— Inter state and Intra state generation

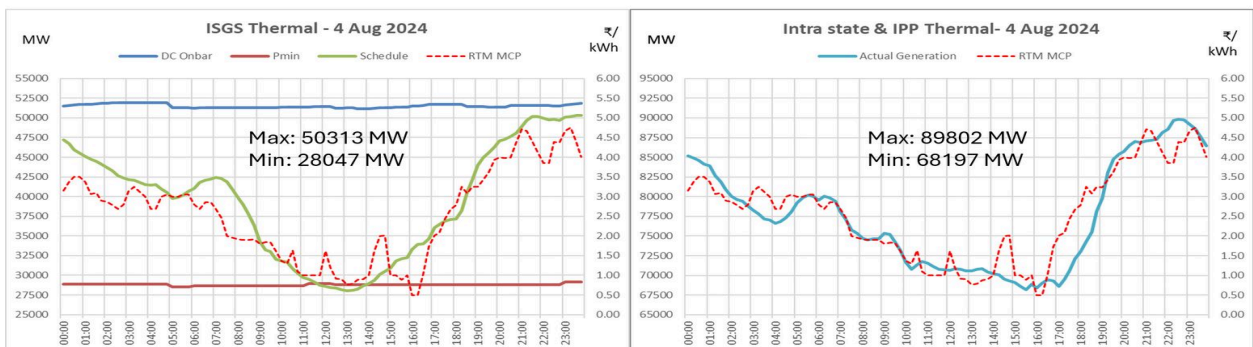

28047/50313 = 56%

68197/89802 = 76%

11



75<sup>th</sup> NRPC Meeting (28 August 2024)-MoM

- A.7.5 During these occasions, some of the NR states such as Punjab, Haryana and Rajasthan were continuously under drawing from the grid.
- A.7.6 Further, as part of IEGC 2023, under clause 31 (4) Resource adequacy mentions that:
- “a) SLDCs shall estimate and ensure the adequacy of resources, identify generation reserves, demand response capacity and generation flexibility requirements with due regard to the resource adequacy framework as specified under Chapter 2 of these regulations.”*
- A.7.7 It was also mentioned that in the meeting held under the chairmanship of Secretary (Power) on 25.07.2024 to discuss the issues related to Grid Management and Grid Operation it has been directed to take appropriate measures by the states for RE curtailment / RSD/ Ramping-up or down w.r.t. the intra-state thermal units for ensuring the grid reliability and security.
- A.7.8 It was further highlighted that this being high hydro season, backing down of hydro generation during peak solar hours may lead to spillage and non-utilisation of available cheap generation. Therefore, support and action from all state utilities is of utmost importance.
- A.7.9 UP SLDC representative stated that they are trying to control grid frequency by taking advance actions and are planning to be slightly on the overdrawl side especially during weekend afternoon time. It was also highlighted that apart from technical minimum, ramp rate requirements as per CEA standards for thermal generation also need to be adhered.
- A.7.10 NRPC forum appreciated the efforts from UP SLDC side.
- A.7.11 Rajasthan SLDC representative stated that as on date intrastate thermal generators are ramping down only to 78%. SLDC has written to RVUN to provide thermal technical minimum support as per CEA regulations. Further, wind generation is still highly unpredictable and its availability/ non-availability needs to be factored in by SLDC to keep the machines on bar. Moreover, DISCOM has been unable to sell power on most days during day-time due to low prices in Real Time Market (RTM). It was mentioned that case study needs to be carried out how SLDC will manage their underdrawl under such circumstances.

*75<sup>th</sup> NRPC Meeting (28 August 2024)-MoM*

- A.7.12 NRLDC representative stated that all available measures are already being taken at ISGS level such as reduction of ISGS thermal to 55%, hydro generation is being rescheduled wherever there is some storage. It was mentioned that as state control area, SLDC needs to cautiously act and take all necessary actions to avoid such underdrawls from the grid. Further, DISCOMs need to place bids such that it gets cleared as during periods of high frequency, prices in RTM will definitely be lower.
- A.7.13 MS NRPC stated this agenda was also discussed in detail in recent WRPC meeting and CEA-thermal division had also expressed a lot of concern regarding insufficient backing down by intrastate thermal generators. It was further informed that in one state, petition was filed from intrastate thermal generators regarding inability to meet the CEA standards for thermal flexibility, SERC in that state had dismissed that petition citing that CEA standards need to be followed by intrastate generators and no exception is allowed. He asked all NR intrastate thermal generating companies to take serious and quick actions in this regard.
- A.7.14 UP SLDC representative further mentioned that UP intrastate thermal generators are already backing down to 55% of their machine continuous rating in real-time. Further, no intrastate thermal generator had expressed inability from their side in meeting these CEA standard requirements.
- A.7.15 Rajasthan SLDC requested that a letter may also be sent from NRPC side to state thermal generating company.
- A.7.16 MS NRPC stated that already letters have been sent from CEA and MoP side. It was mentioned that a letter may be sent from MS NRPC side to states for backing down their technical minimum at least to 55% of their MCR as per CEA standards.
- A.7.17 Forum discussed on the following suggestions for mitigating high frequency grid operation to be followed by utilities are listed below:
- State control area generators to backdown to their technical minimum. Technical minimum of State control area plants should be set at 55% of the installed capacity minus auxiliary consumption.
  - Due to rainy weather conditions particularly in weekends, some of the units on high merit may be put under Reserve Shutdown in the state control area.
  - Improvement in demand forecast by states would prevent in wide gaps in anticipated demand and actual drawl.

*75<sup>th</sup> NRPC Meeting (28 August 2024)-MoM*

- Taking cues from Day ahead Market and RTM prices decision on putting higher merit order plants on Reserve Shut down can be taken. If required, power can be purchased in DAM or RTM under such scenarios.
- Hydro plants in state control area not under spillage condition may be scheduled as per system requirement.
- Gas plants in state control area which are underdrawing should be put in Reserve Shutdown at the earliest.
- Participation in TRAS of intrastate generators will further improve the system conditions as in case of high frequency TRAS down in intrastate plants can be despatched.

***Decision of Forum***

*Forum asked all SLDCs to take measures as discussed above. Further, all intrastate thermal generating units need to expedite their actions for backing down their technical minimum at least to 55% as per Central Electricity Authority (Flexible Operation of Coal based Thermal Power Generating Units) Regulations, 2023. A letter may be sent from MS NRPC side to states for backing down their technical minimum at least to 55% of their MCR as per CEA standards.*

**A.8 Expediting commissioning of Sikar-II transmission system (agenda by NRLDC)**

- A.8.1 NRLDC representative apprised that Transmission system strengthening scheme for evacuation of power from solar energy zones in Rajasthan (8.1 GW) under phase II –Part C was approved in 5<sup>th</sup> meeting of NRSC held on 13.09.2019. Subsequently, SPV named POWERGRID Sikar Transmission Ltd., was acquired on 04.06.2021 and as per TSA implementation schedule was provided as Dec 2022 for commissioning of 765/400kV Sikar-II and associated transmission system.
- A.8.2 NRLDC representative stated that there has been delay of more than one and half year with respect to commissioning of 765 KV Sikar 2 PG sub-station. Due to non-availability of Sikar 2 sub-station the Rajasthan ISTS RE system is already deeply stressed and the lines from RE complex remain heavily loaded. Nearly 4200 MW RE generation has been connected in Western Rajasthan which does not have its associated EHVAC transmission system. There are issues related to high loadings in the RE complex and not feasible to provide major shutdowns of existing transmission

75<sup>th</sup> NRPC Meeting (28 August 2024)-MoM

lines such as outage of 765 KV Bikaner-Moga D/C line as it would further stress the available transmission system.

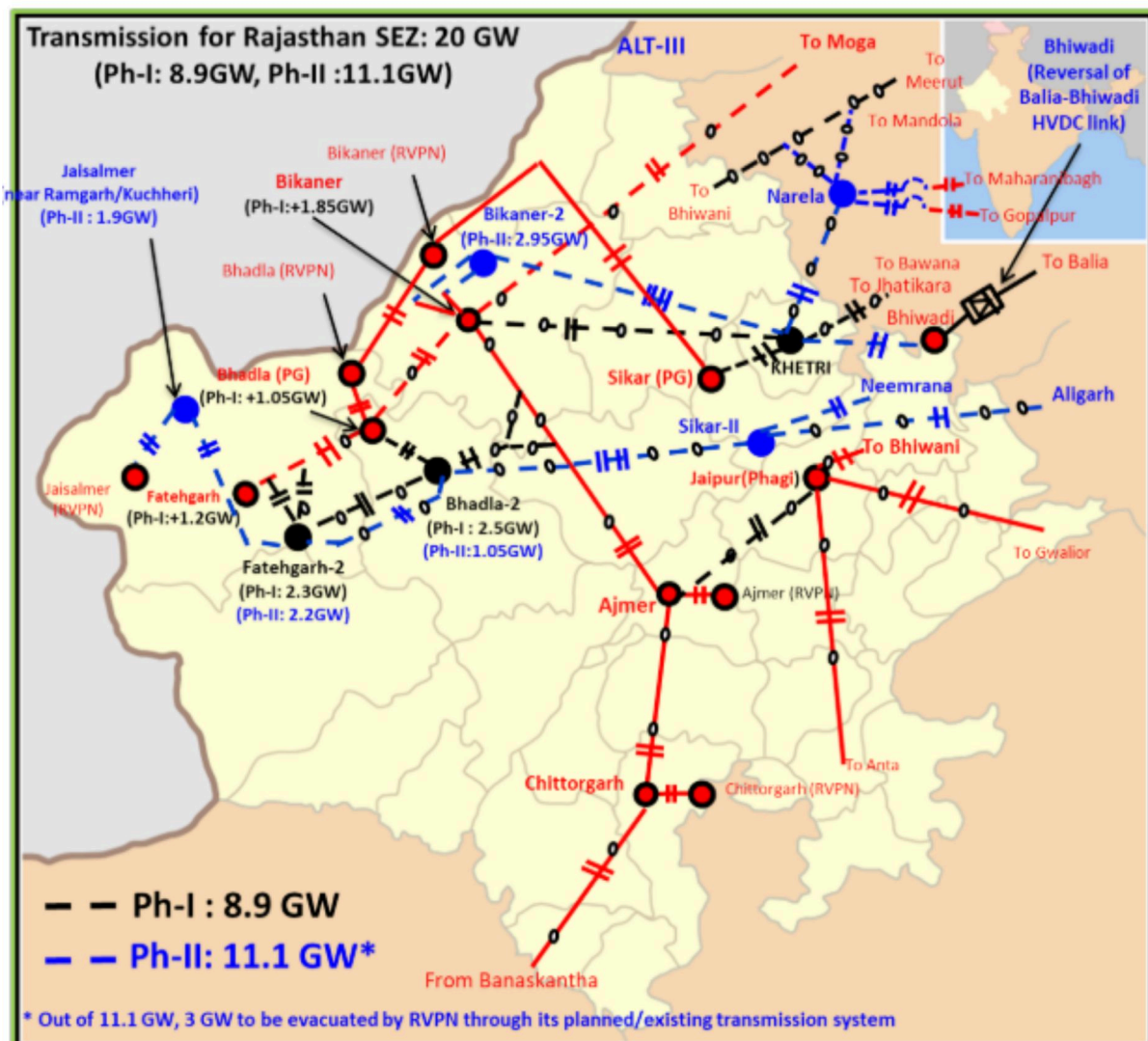

A.8.3 In case of availability of 765 KV Bhadla2-Sikar-2 line, 765 KV-Bhadla 2-Sikar-2 lines and 765kV Sikar2- Aligarh and 400kV Sikar-2-Neemrana lines, the RE complex would be connected to load centers. Interconnection with load will also help to stabilise the grid and the impact of frequent transient fault impact could be minimized.

A.8.4 Recently, the proposed shutdown of 765kV Bikaner-Moga are regularly being discussed at OCC levels, wherein it has been discussed that if this shutdown is allowed at present, there shall be RE curtailment of the order of 1500 MW to 3500 MW under different scenarios. In view of above, shutdown of 765 KV Bikaner - Moga

*75<sup>th</sup> NRPC Meeting (28 August 2024)-MoM*

D/C cannot be allowed in the present scenario considering the quantum of RE curtailment.

- A.8.5 Accordingly, NRLDC has requested POWERGRID to expedite commissioning of 765 KVBhadla-2-Sikar-2, 765kV Sikar-2- Aligarh and 400kV Sikar-2-Neemrana transmission lines along with Sikar-2 substation to ensure safe evacuation of RE generation and to facilitate required shutdowns in the RE complex.
- A.8.6 In the remaining portion of the current financial year (2024-25), approx. 4000 MW additional RE is proposed to be integrated progressively in the Rajasthan RE complex. However, with the existing transmission network, it is not possible to evacuate further RE generation, till additional transmission system including Sikar-II system is charged. The present grid is already under lot of stress in Western Rajasthan and all efforts are being made from NRLDC side to maximize the evacuation of RE power. Therefore, actions are required from POWERGRID side on war footing basis. Although 765kV Bhadla2-Fatehgarh2 2nd D/C helped to strengthen network at Fatehgarh-II, however, this would further increase loading on 765kV Bhadla-2-Ajmer D/C transmission lines which is already heavily loaded. Therefore, commissioning of 765/400kV Sikar-II along with associated transmission system is required at the earliest.
- A.8.7 POWERGRID was requested to expedite commissioning of 765 KV-Bhadla 2-Sikar-2 lines and 765kV Sikar2- Aligarh and 400kV Sikar-2-Neemrana lines transmission lines along with 765/400kV Sikar-2 substation.
- A.8.8 POWERGRID representative informed that land was provided to POWERGRID in December 2023 for Sikar-II and accordingly the project was slightly delayed. Following timelines were provided for anticipated transmission elements during the meeting:
- 765kV Bhadla2-Sikar-2 D/C is expected by Nov-Dec 2024.
  - 400kV Sikar-2-Neemrana D/C lines is expected by Sep 2024 end.
  - 765kV Sikar-2-Aligarh D/C lines is expected by Oct 2024 end.
  - 765/400kV Sikar-2 substation is expected by Dec 2024, therefore all elements will be effectively charged by Dec 2024.

***Decision of Forum***

*Forum noted the timelines provided by POWERGRID. In view of anticipated approx. 4000 MW additional RE integration in the Rajasthan RE complex in F.Y. 2024-25,*

*75<sup>th</sup> NRPC Meeting (28 August 2024)-MoM*

*POWERGRID was asked to expedite their works for commissioning of 765/400kV Sikar-2 and associated transmission lines.*

**A.9 Recommendations of the committee to analyse the grid event happened at 13:53 hrs on 17<sup>th</sup> June 2024 due to tripping of HVDC Champa-Kurukshetra (agenda by NRPC Secretariat)**

A.9.1 EE (P), NRPC apprised that on 17<sup>th</sup> June 2024, a grid event occurred at 13:53 hours in the Northern Region, leading to a substantial load reduction of approximately 16.5 GW. This event started with the tripping of both bipoles of the +/-800 kV HVDC Champa (WR) – Kurukshetra (NR) link, which was transferring 4500 MW of power from the Western Region (WR) to the Northern Region (NR). The tripping of this HVDC link triggered a series of events. There was a sudden voltage drop across the stations in the Northern region which resulted in a significant load drop of around 16.5 GW in the Northern region. There was simultaneous reduction of around 2800 MW of RE-based generation in the Rajasthan RE complex. There was also trippings of conventional generating units leading to a generation loss of 3909 MW at the all-India level. The significantly higher load loss resulted in the rise in frequency of the Indian power system from 50.03 Hz to 50.68 Hz. The load drop resulted in a rise in the voltages of stations in the Northern region. This high voltage resulted in the tripping of 18 nos. of EHVAC lines in the Northern Region on over-voltage protection. The power system was normalised after the revival of all the poles of HVDC Champa-Kurukshetra by 15:51 Hrs.

A.9.2 He added that Ministry of Power vide its order no. 6/3/2024-Trans dated 25.06.2024 constituted a Committee under the Chairmanship of Member (GO&D), CEA to analyse the above-mentioned issues during which about 16.5 GW of consumer load in Northern Region got interrupted for a brief period. The composition of the Committee is given as under:

- (i) Member (GO&D), CEA Chairman
- (ii) Director (SO), GRID-INDIA Member
- (iii) Deputy Chief Operating Officer, CTUIL Member
- (iv) Executive Director, NTAMC (POWERGRID) Member
- (v) Professor, Electrical Engineering, IIT Delhi Member
- (vi) Member Secretary, NRPC Member Convener

*75<sup>th</sup> NRPC Meeting (28 August 2024)-MoM*

- A.9.3 Accordingly, the Committee conducted five meetings and detailed analysis of the grid event was carried out by teams of CEA, IIT-Delhi, NRPC, NLDC, NRLDC, POWERGRID, SLDC Delhi & DISCOMs of Northern Region States and the Report was finalized and submitted its report to MoP on 24.7.2024.
- A.9.4 The committee has found some major observations, the brief of which are as below-
- (i) Outage of all four poles of HVDC Champa - Kurukshetra link (N-4 scenario)-** There was tripping of +/-800 kV HVDC Champa-Kurukshetra link (4500 MW) triggered load loss event. Localized storm caused jumper swing and flashover. It Redundancy in DMR has also been observed. Over 30 trippings of HVDC link from Jan-Jun 2024. Detailed fault analysis and remediation needed to enhance reliability.
  - (ii) Cause of Voltage dip and high Reactive Power Drawl by loads:** - There was significant voltage drops across Northern Region and Reactive power absorption increased, exacerbating voltage issues.
  - (iii) Analysis of behavior of Load during the event:** Voltage reduction caused stalling of induction motors: total 16.5 GW load Reduced in NR. Stalling of motors at comparatively higher voltages (~0.85 - 0.9 p.u. voltage).
  - (iv) Impact on Conventional and Renewable Energy Generation:** Approximately 2800 MW of RE generation was reduced with around 1500 MW recovering within 4 minutes. 16 Conventional Generating Units tripped.
  - (v) Reactive Power Support from Generating Units in NR:** Heavy reactive power drawl by loads were observed. Many RE plants have opposite response.
  - (vi) High Voltage Scenario:** Total 18 (no.) of transmission lines (765kV and 400kV) tripped on OV, causing a partial blackout at the 765/400kV Aligarh (PG) S/s.
  - (vii) Frequency Response by Generating Units:** More than 50% capacity of the inter-state generators and more than 85% capacity of the intrastate generators exhibited inadequate governor response during the event.
  - (viii) Reactive Power Management:** The event highlighted the need for effective reactive power management. Heavy reactive power drawl was observed, leading to further voltage reductions.
  - (ix) Information sharing and Co-ordination:** Timely report submissions and communication are essential.

*75<sup>th</sup> NRPC Meeting (28 August 2024)-MoM*

A.9.5 The committee recommended the following remedial measures for avoiding the recurrence of such grid event:

- (i) Reactive Power Management (Dynamic/Static) by STU and DISCOMs:** In order to maintain voltage stability, reactive power support is desired from all grid connected utilities without leaning over each other so as to ensure minimum reactive exchange at different voltage levels.
- (ii) Planning for dynamic reactive power sources near load centers based on load composition:** Adequate static/dynamic reactive devices may be planned at the distribution level near loads so that there is minimum drawl from reactive sources at the transmission (STU) level. The dynamic reactive power sources shall be commissioned near load centre stations based on the composition and quantum of individual load type.
- (iii) Enhance reliability of HVDC Link:** Committee recommended POWERGRID to the followings-
  - a. Review of protection schemes to avoid frequent outages.
  - b. Review of transmission line design including cross arms, jumpers, etc.
  - c. Design of filter switching logic to support system voltage.
- (iv) Implementation of Overvoltage protection setting:** followings were recommended for implementing overvoltage Stage-I protection settings:
  - a. Pick up voltage & time delay setting of Antitheft lines to be kept low with sufficient time gap from other lines at S/s
  - b. Parallel lines grading to be done such that one line should trip early by setting at low voltage and other line should trip last by keeping setting at high voltage.
  - c. Highly loaded lines should be given last priority in tripping.
  - d. Net MVAR relief (based on line charging MVAR & MVAR compensation in line) based on the simulation to be considered for arriving at the priority of line tripping. Lines providing high net MVAR relief to be tripped early.
  - e. Grading to be done in such a manner that one major incoming and outgoing line shall remain connected after tripping of lines at any node.
  - f. Protection setting of remote end station of a line need to be coordinated so as to avoid tripping of line from other end.
  - g. Drop-off to pick-up ratio of Relays implemented for overvoltage protection shall be more than 99.5%.



*75<sup>th</sup> NRPC Meeting (28 August 2024)-MoM*

- (v) Frequency Response by Generating Units as per IEGC 2023:** It was recommended that the performance of generating units where inadequate primary response was observed shall be discussed at RPC level.
- (vi) Compliance of CEA Standards by Renewable Generating Plants:** RE generators must comply the CEA Standards. Committee recommended the followings-
- a. Protection settings of inverters/WTG shall be coordinated in such a way that it accounts for the voltage rise/drop between inverter/WTG terminal & Point of interconnection (POI). Overvoltage /undervoltage trip settings should be configured accordingly.
  - b. The reactive power controller settings (droop, deadband, power factor, operating modes) in inverters/WTGs should be configurable and shall be set in consultation with the respective load dispatch centre.
  - c. The protection settings of elements in collector system viz. transformers, cables etc. shall such that it allows RE plants to ensure the compliance of CEA standards at POI.
  - d. RE plants shall ensure that the event records shall be shared with SLDC/RLDC within the stipulated time for event analysis. All such data shall be retained in a retrievable format in a suitable archival system.
- (vii) Retain of Conventional generators near load centers for providing grid support during such events:** The presence of thermal generators near the load centres may significantly improve the voltage profile and can provide dynamic reactive power support in case of contingencies improving the stability.
- (viii) Compliance of Standards by Load Serving Machines:** The stalling of motors at high voltage (0.85-0.9 pu) is to be investigated and the motors serving load need to be compliant with IS/IEC.
- (ix) Amendments in Existing Regulations:** For ensuring reliable operation, provisions related to different emerging types of loads (Electrolysers etc.) may be added in the existing CEA standards.

A.9.6 MS, NRPC conveyed that review of overvoltage grading of 765kV and 400kV transmission lines need to be done. In view of this, an agenda may be listed in the Protection Sub-Committee meeting.

75<sup>th</sup> NRPC Meeting (28 August 2024)-MoM

- A.9.7 He highlighted that collective wisdom and approach of all stakeholders are necessary to enhance the strength of Grid.

**Decision of Forum**

*Forum acknowledged the sensitivity of event and directed the concerned to take appropriate actions based on the recommendations of Committee.*

**A.10 Reimbursement of medical bills submitted by Shri Sunny Mann, Lower Division Clerk, working in NRPC Secretariat (agenda buy NRPC Secretariat)**

- A.10.1 Assistant Secretary, NRPC apprised that on 03/05/2024, Shri Sunny Mann's mother (Mrs. Shakuntala) was admitted to Max Hospital, Shalimar Bagh, New Delhi in emergency condition due to heart problem. In the Emergency Certificate presented by Max Hospital, Shalimar Bagh, New Delhi, it is stated that due to the problem of HFrEF, LBBB, CHF, Mrs. Shakuntala was treated from 03/05/2024 to 08/05/2024.
- A.10.2 Further, Mr. Sunny Mann has submitted claim for reimbursement of medical expense bills of Rs 5,92,541/- incurred on the treatment of his mother under emergency (Mrs. Shakuntala). (attached as **Annexure- IX**)
- A.10.3 Further, as per OM no. 12034/02/2014/Misc/-CGHS D.III dated 22.07.2014 (copy attached as **Annexure-X**) of Ministry of Health and Family Welfare, in case of implantation of any of the any of the devices in emergency, reimbursement shall be subject to ex-facto approval by Addl. Director/ Joint Director, CHGS of city, in consultation with experts, if necessary. In view of above, ex-facto approval has been granted vide letter dated 30.7.2024 of office of the Additional Director, CGHS (HQ). (attached as **Annexure-XI**)
- A.10.4 The details of the medical bills submitted by Mr. Sunny Mann are shown in the table as below-

S. No	Claimant Shri/Sm t.	Patient Relationship with Claimant	Hospital / Diagnostic Centre where treatment taken	Brief Description of Treatment	Bill No. & Date (Diary No.& Date)	Amount Claimed with GST (In Rs.)	Amount Admissible (In Rs.)
1.	Sunny Mann	Mother	Max Hospital , Delhi	Angiography, TPI,ICD, CRT-D Combo	1789, 8/5/2024	5,92,541/-	5,92,541/-

75<sup>th</sup> NRPC Meeting (28 August 2024)-MoM

				Device Implantation			
<b>Total Amount</b>						<b>5,92,541/-</b>	<b>5,92,541/-</b>

- A.10.5 The amount of the above bill is more than Rs 5,00000/-. Ministry of Health & Family Welfare Office Memorandum File No: S-14025/24/2023/EHS Dated 15<sup>th</sup> January, 2024, point no. 3 states that in respect of cases involving payment of medical bills exceeding Rs 5 lakh but as per the prescribed rate list, the concerned departments/ministries may dispose of such cases in consultation with their respective Internal Finance Divisions (IFD). Only in those cases where the settled rules/ schemes are required to be relaxed, should the case be referred to the Ministry of Health and Family Welfare. Copy of the same is enclosed as **Annexure-XII**.
- A.10.6 Further, as per point 4.1 of SOP i.e. annexure-II of the office order of CEA Budget Section File no. 1/1/2023-Bud(CEA)/1302-1308 Dated 01/05/2023, CEA shall be IFD for only those budget heads (salary) which has been allocated by CEA. For all other expenditure, approvals shall be taken in the RPC meeting only. Copy of order is enclosed as **Annexure-XIII**.
- A.10.7 Accordingly, the agenda was put up in the meeting for approval of the reimbursement of the above bill as per CGHS rules.
- A.10.8 MS, NRPC asked the consent of all members for reimbursement as procedural requirement of office. Members gave consent to reimburse the medical bills.

**Decision of Forum**

*Forum accorded the approval for reimbursement of medical bills as per CGHS rules in r/o Smt Shakuntla Devi m/o Shri Sunny Mann, Lower Division Clerk, working in NRPC Secretariat for Rs. 5,92,541/-.*

**A.11 Status of Expenditure During Quarter-1 of FY 2024-25 from NRPC Fund (agenda by NRPC Secretariat)**

- A.11.1 Assistant Secretary, NRPC apprised that as per Standard Operating Procedure (SOP) for budgeting and expenditure of RPCs in pursuance to the MoP letter dated 23.02.2006, NRPC had finalized its annual Internal Budget for FY 2024-25 and got it approved by forum in the 72<sup>nd</sup> NRPC meeting held on 30.03.2024. In line with the

75<sup>th</sup> NRPC Meeting (28 August 2024)-MoM

budget finalized, status of actual expenditure incurred during Quarter-1 of FY 2024-25 (All figures in Rs.) is as follows:

<b>Account Head</b>	<b>Budget Estimate for FY 2024-25</b>	<b>Remarks/ Booking of Expenditure during Q1/FY 2024-25</b>	<b>Total Expenditure during Q1/FY 2024 25</b>
Salary	1,97,00,000	Salary bills	95,35,545
Rewards	1,00,000	Bonus for Group-C Employees	
Allowances	10,00,000	HRA, DA etc	
LTC	1,53,00,000	LTC	
Medical Treatment	5,00,000	Cost of Medical Treatments	2,87,904
Training	5,00,000	Training Expenses of NRPC Officials	1,77,000
DTE	15,00,000	Domestic tour expense	1,75,240
OE	1,00,00,000	Office expenditure- Recurring expenses of salary of contractual staff, AMC and other bills.	24,88,497
RRT	4,00,000	Rent rate and Taxes- One time expense of property tax.	1,70,534
Digital Equipment	5,00,000	Digital equipment (cartridges, Hard Disks, pen drive etc.)	1,32,430
Repair and Maintenance	1,50,00,000	ARMO, Civil & Electrical works in NRPC Complex through CPWD, AMC of IT Maintenance.	7,68,900
Other Revenue Exp.	7,00,000	Hospitality and other similar bills (Mobile, Newspaper Bills etc)	81,940
Machinery	15,00,000	Machinery and equipment	0

75<sup>th</sup> NRPC Meeting (28 August 2024)-MoM

and Equipment		like lift etc.	
IT & Computer Applications etc	3,00,000	Cyber Security and Hybrid VC projects and other related works.	0
Furniture and fixtures	15,00,000		0
NRPC Reimbursement FY 2023-24		Salary and allowances expenses from 01/01/2024 to 29/02/2024 NRPC Reimbursement FY 2023-24	43,73,128
<b>Total</b>	<b>6,85,00,000</b>		<b>1,81,91,118</b>

**Decision of Forum**

Forum noted the information.

**A.12 Outstanding Contribution for FY 2024-25 (agenda by NRPC Secretariat)**

A.12.1 AS, NRPC apprised that Demand Letter for contribution towards NRPC fund for the year 2024-25 was sent on 10.04.2024 to all the constituent members. It was also mentioned that beyond 30<sup>th</sup> June, 1 % simple interest shall be levied. Accordingly, NRPC Secretariat has received contributions from organisations.

A.12.2 It is mentioned that payment has been received from 42 constituent members.

A.12.3 Details of organizations from where payment has not been received are mentioned below:

S. No	Name of Constituent	Period (FY)	Outstanding Contribution amount (Rs)	Outstanding Penalty (Rs)	Total Outstanding amount (Rs)
1	UT of Ladakh	2024-25	12,00,000	24,000	12,24,000
2	UT of Chandigarh	2024-25	12,00,000	24,000	12,24,000
3	FBTL*	2024-25	0	12000	12000
4	TSPL**	2024-25	0	24000	24000

75<sup>th</sup> NRPC Meeting (28 August 2024)-MoM

	<b>Total</b>	<b>Rs 24,84,000</b>
--	--------------	---------------------

*\*amount of 12,00,000 Rs from FBTL was received in NRPC fund on 04.07.2024 i.e., beyond due date of 30.06.2024.*

*\*\* amount of 12,00,000 Rs from TSPL was received in NRPC fund on 22.08.2024 i.e., beyond due date of 30.06.2024.*

- A.12.4 It is mentioned that Reminder letter for payment was sent to these constituent members on 8<sup>th</sup> July,2024 (enclosed). DO Letter from MS, NRPC was also sent on 12.08.2024 (enclosed). However, payment has not been received till date.
- A.12.5 It is also mentioned that FBTL was communicated for the interest amount vide email dated 9<sup>th</sup> August, 2024. However, payment is awaited.
- A.12.6 Above organizations are requested to kindly pay the contribution amount at the earliest to avoid further penalty charges.

### **Decision of Forum**

*Forum directed the concerned to pay the outstanding contribution along with penalty as applicable.*

### **A.13 Inclusion of RE generators having more than 1000 MW installed capacity as permanent members of NRPC (agenda by NRPC Secretariat)**

- A.13.1 EE (P), NRPC apprised that as per MoP gazette resolution dated 03.12.2021, inter-alia, following has been mentioned as member of RPCs:

***A representative each of every generating company (other than central generating companies or State Government owned generating companies) having more than 1000 MW installed capacity in the region***

- A.13.2 He added that in the 49th TCC and 72nd NRPC meeting held on 29-30 March, 2024, the list of NRPC members was finalized and approved as **Annexure-XIV**. In the meeting, RE generators were not proposed as members under category of 'generating company (other than central generating companies or State Government owned generating companies) having more than 1000 MW installed capacity in the region' because individual installed capacity of SPVs of RE plants remains below 1000 MW.

*75<sup>th</sup> NRPC Meeting (28 August 2024)-MoM*

- A.13.3 He mentioned that the matter has been discussed in RPC Review meeting chaired by Chairperson, CEA on 07.08.2024 and it has been decided that RE generating companies having cumulative installed capacity more than 1000 MW in the region may be considered as member of RPCs as per above gazette resolution.
- A.13.4 In view of above, it was proposed that RE generating companies having aggregated capacity more than 1000MW in the region may be made permanent NRPC members. Accordingly, following organizations may be made members of NRPC starting from FY 2024-25:
- i. Adani Green Energy Limited,
  - ii. ReNew Power Private Limited,
  - iii. Azure Power India Pvt. Limited,
  - iv. Avaada Energy Private Limited
  - v. NTPC Renewable Energy Limited
- A.13.5 The membership contribution for the year 2024-25 was decided to be Rs. 12 lakh per member.
- A.13.6 Further, he highlighted that inclusion of above organizations shall provide them a platform for deliberation and resolution of various issues.
- A.13.7 A demand letter regarding membership contribution (Rs. 12 lakh per member) for the year 2024-25 may be sent to these RE generating companies.
- A.13.8 NTPC Green Energy Limited representative stated that NTPC Renewable Energy Limited may be corrected as NTPC Green Energy Limited.
- A.13.9 Further, NTPC Green Energy Limited representative mentioned that due to lack of infrastructure, all the issues of Renewables are being taken up by its parent organization i.e. NTPC itself. In view of this, he intimated that the management of NTPC Green Energy Limited is not willing to become the permanent member for the current FY. MS, NRPC requested him to apprise the management regarding gazette resolution and accordingly, NTPC Green Energy Limited may send reply in writing.

***Decision of Forum***

*Forum approved the proposal and decided the followings:*

- i) Inclusion of RE generating companies having more than 1000 MW installed capacity in the region as permanent members of NRPC.*
- ii) Accordingly, a demand letter regarding membership contribution (Rs. 12 lakh per member) for the year 2024-25 shall be sent to following companies:*

75<sup>th</sup> NRPC Meeting (28 August 2024)-MoM

- a. *Adani Green Energy Limited,*
  - b. *ReNew Power Private Limited,*
  - c. *Azure Power India Pvt. Limited,*
  - d. *Avaada Energy Private Limited*
  - e. *NTPC Green Energy Limited.*
- iii) *All these members may pay the membership contribution within two months of demand letter.*

**A.14 Non-member participants in NRPC (agenda by NRPC Secretariat)**

- A.14.1 EE (P), NRPC apprised that it has been gathered through various meetings held in past that many utilities which are not the members of NRPC, desire to attend the meetings on their agenda.
- A.14.2 He added that the matter has been discussed in RPC Review meeting chaired by Chairperson, CEA on 07.08.2024 and it has been decided that RPCs may have 'Non-member participants' in their region.
- A.14.3 Accordingly, it is proposed that NRPC may also allow Non-member participants . These participants shall be invited in meetings only if their agenda is to be discussed. They shall pay 50% of annual fee. This shall be on basis of willingness of utilities. Organizations who are willing to become Non-member participants of the NRPC may express their willingness.
- A.14.4 Accordingly, demand letter may be issued from NRPC Secretariat for depositing half of contribution fee (i.e. INR 6 Lac for FY24-25). These Non-member participants can list their agenda for discussion in NRPC meeting and may attend the meeting. However, they may not attend NRPC meetings when there is no agenda of theirs. Further, they may attend sub-committees of NRPC such as OCC Sub-Committee, Protection Sub-Committee, TeST Sub-Committee, RE Sub-Committee, Commercial Sub-Committee on regular basis.
- A.14.5 Forum was informed that this practice is already in place in ERPC.
- A.14.6 MS, NRPC conveyed that this optional choice will help out the utility to place their issues before the Forum and their expertise will also be shared with all members of Forum.

***Decision of Forum:***

*Forum approved the proposal and decided the followings:*



75<sup>th</sup> NRPC Meeting (28 August 2024)-MoM

- i) Organizations may express their willingness to MS, NRPC for becoming Non-member participants.
- ii) Accordingly, MS, NRPC may issue demand notice for payment of annual participation fee as 50% of membership fee.

**A.15 Amendment in Conduct of Business Rules (COBR) of NRPC to include MNRE, SECI etc. as members in RE Sub-Committee (agenda by NRPC Secretariat)**

A.15.1 MS, NRPC apprised that during RPC Review meeting chaired by Chairperson, CEA on 07.08.2024, it has been decided that MNRE, SECI and Associations of RE generators may be included as a member in RE-Sub-Committee of NRPC.

A.15.2 Accordingly, it was proposed to amend COBR to include SECI, MNRE and Associations of RE generators as member of RE- Sub Committee. In view of this, the proposed amendment in COBR is attached as **Annexure-XV**.

**Decision of Forum**

Forum gave consent to amend COBR to include SECI, MNRE and Associations of RE generators as member of RE- Sub Committee. Accordingly, amended COBR is attached as **Annexure-XV**.

**A.16 Hiring of Manpower in NRPC secretariat through GeM Portal under Manpower Outsourcing Services - Minimum Wages Contract for various categories (agenda by NRPC Secretariat)**

A.16.1 EE (P), NRPC apprised that in 74<sup>th</sup> NRPC meeting, Forum approved the proposal of Hiring of Manpower in NRPC secretariat through GeM Portal under Manpower Outsourcing Services - Minimum Wages Contract for various categories so that bidding process through Gem Portal could be initiated to place manpower before expiring of Contract GEMC-511687763578746 on 10.08.2024 for Manpower Outsourcing Services in NRPC Secretariat.

A.16.2 Accordingly, Bid (GEM/2024/B/5115663) for Manpower Outsourcing Services – Minimum Wages Contract was floated on GeM Portal. Thereafter, Bid has been awarded through Gem Contract GEMC-511687739668308 to successful L1 Bidder M/s Littgo Industries at a cost of Rs 68,48,595.47/- with contract starting from 11-Aug-2024 to 10-Aug-2025 for 18 nos. of Manpower tabulated as under:

**Table -1**

75<sup>th</sup> NRPC Meeting (28 August 2024)-MoM

S. no.	Category	Nos of Manpower	Skill Level
1	Sweeper	6	Unskilled
2	Mali/Gardner	1	Semi-skilled
3	Watch & Ward	4	Skilled
4	Data Entry Operator	2	Skilled
5	Electrician	1	Skilled
6	Cook	1	Skilled
7	Canteen Helper	1	Unskilled
8	Plumber	1	Skilled
9	Carpenter	1	Skilled

A.16.3 Further, he mentioned that as per minutes of meeting of 74<sup>th</sup> NRPC meeting wherein it was said that NRPC Secretariat shall take fresh approval after finalization of bid, once L1 bidder is decided through Gem Portal.

A.16.4 In view of above, it was proposed that the awarded Bid through Gem Contract GEMC-511687739668308 to successful L1 Bidder M/s Littgo Industries at a cost of Rs 68,48,595.47/- with contract starting from 11-Aug-2024 to 10-Aug-2025 for 18 nos. of Manpower under various categories as stipulated in Table-1 may be approved.

A.16.5 MS, NRPC highlighted that the wages rates of labours under Delhi Government has also got increased for 1<sup>st</sup> April, 2024 that led to increased cost of actual bid.

### **Decision of Forum**

*Forum approved the above proposal and noted the same.*

### **A.17 Proposal for conducting TCC meeting also NRPC meeting on the same VC link in future (agenda by NRPC Secretariat)**

A.17.1 MS, NRPC proposed to invite the TCC members in the NRPC meetings on the same VC link in future. By this, discussion in the meeting will strengthen by the knowledge of technical experts. Forum was also of the same view.

### **Decision of Forum**

*Forum approved the proposal to invite TCC members also in NRPC meetings held via VC.*

\*\*\*\*\*

**NRPC Members for FY 2024-25**

S. No.	NRPC Member	Category	Nominated/ Notified/Delegated Member	E-mail
1	Member (GO&D), CEA	Member (Grid Operation & Distribution), Central Electricity Authority (CEA)	Member (GO&D), CEA	<a href="mailto:member.god@cea.nic.in">member.god@cea.nic.in</a>
2	Member (PS), CEA	Nodal Agency appointed by the Government of India for coordinating cross-border power transactions	Member (PS), CEA	<a href="mailto:memberscea@nic.in">memberscea@nic.in</a>
3	CTUIL	Central Transmission Utility	Chief Operating Officer	<a href="mailto:pcgarg@powergrid.in">pcgarg@powergrid.in</a>
4	PGCIL	Central Government owned Transmission Company	Director (Operations)	<a href="mailto:tyagtr@powergrid.in">tyagtr@powergrid.in</a>
5	NLDC	National Load Despatch Centre	Director (System Operation)	<a href="mailto:rk_porwal@grid-india.in">rk_porwal@grid-india.in</a>
6	NRLDC	Northern Regional Load Despatch Centre	Executive Director	<a href="mailto:nroy@grid-india.in">nroy@grid-india.in</a>
7	NTPC	Central Generating Company	Director (Finance)	<a href="mailto:jaikumar@ntpc.co.in">jaikumar@ntpc.co.in</a>
8	BBMB		Chairman	<a href="mailto:cman@bbmb.nic.in">cman@bbmb.nic.in</a>
9	THDC		CGM (EM-Design)	<a href="mailto:rrsemwal@thdc.co.in">rrsemwal@thdc.co.in</a>
10	SJVN		CMD	<a href="mailto:sectt.cmd@sjvn.nic.in">sectt.cmd@sjvn.nic.in</a>
11	NHPC		Director (Technical)	<a href="mailto:rajikumar0610.rkc@gmail.com">rajikumar0610.rkc@gmail.com</a>
12	NPCIL		Director (Finance)	<a href="mailto:df@npcil.co.in">df@npcil.co.in</a>
13	Delhi SLDC		General Manager	<a href="mailto:gmsldc@delhisldc.org">gmsldc@delhisldc.org</a>
14	Haryana SLDC		Chief Engineer (SO&C)	<a href="mailto:cesocmm1@hvpn.org.in">cesocmm1@hvpn.org.in</a>
15	Rajasthan SLDC		Chief Engineer (LD)	<a href="mailto:ce.ld@rvpn.co.in">ce.ld@rvpn.co.in</a>
16	Uttar Pradesh SLDC		Director	<a href="mailto:directorsldc@upsldc.org">directorsldc@upsldc.org</a>
17	Uttarakhand SLDC		Chief Engineer	<a href="mailto:anupam_singh@ptcul.org">anupam_singh@ptcul.org</a>
18	Punjab SLDC	Chief Engineer	<a href="mailto:ce-sldc@punjabslcdc.org">ce-sldc@punjabslcdc.org</a>	
19	Himachal Pradesh SLDC	Managing Director	<a href="mailto:mdhpsldc@gmail.com">mdhpsldc@gmail.com</a>	
20	DTL	CMD	<a href="mailto:cmd@dtl.gov.in">cmd@dtl.gov.in</a>	
21	HVPNL	Managing Director	<a href="mailto:md@hvpn.org.in">md@hvpn.org.in</a>	
22	RRVUNL	CMD	<a href="mailto:cmd.rvvn@rvpn.co.in">cmd.rvvn@rvpn.co.in</a>	
23	UPPTCL	Managing Director	<a href="mailto:md@upptcl.org">md@upptcl.org</a>	
24	PTCUL	Managing Director	<a href="mailto:md@ptcul.org">md@ptcul.org</a>	
25	PSTCL	CMD	<a href="mailto:cmd@pstcl.org">cmd@pstcl.org</a>	
26	HPPTCL	Managing Director	<a href="mailto:md.tcl@hpmail.in">md.tcl@hpmail.in</a>	
27	IPGCL	Managing Director	<a href="mailto:md.ipgpp@nic.in">md.ipgpp@nic.in</a>	
28	HPGCL	Managing Director	<a href="mailto:md@hpgcl.org.in">md@hpgcl.org.in</a>	
29	RRVUNL	CMD	<a href="mailto:cmd@rvvn.com">cmd@rvvn.com</a>	
30	UPRVUNL	Director (Technical)	<a href="mailto:director.technical@uprvunl.org">director.technical@uprvunl.org</a>	
31	UJVNL	Managing Director	<a href="mailto:mdujvnl@ujvnl.com">mdujvnl@ujvnl.com</a>	
32	HPPCL	Managing Director	<a href="mailto:md@hppcl.in">md@hppcl.in</a>	
33	PSPCL	State Generating Company & State owned Distribution Company	CMD	<a href="mailto:cmd-ppcpl@pspccl.in">cmd-ppcpl@pspccl.in</a>
34	UHBVN	State owned Distribution Company (alphabetical rotational basis/nominated by state govt.)	Managing Director	<a href="mailto:md@uhbvn.org.in">md@uhbvn.org.in</a>
35	Jodhpur Vidyut Vitran Nigam Ltd.		Managing Director	<a href="mailto:md.jdvnl@rajasthan.gov.in">md.jdvnl@rajasthan.gov.in</a>
36	Paschimanchal Vidyut Vitran Nigam Ltd.		Managing Director	<a href="mailto:md@pvvnl.org">md@pvvnl.org</a>
37	UPCL		Managing Director	<a href="mailto:md@upcl.org">md@upcl.org</a>
38	HPSEB		Managing Director	<a href="mailto:md@hpseb.in">md@hpseb.in</a>
39	Prayagraj Power Generation Co. Ltd.		Head (Commercial & Regulatory)	<a href="mailto:sanjay.bhargava@tatapower.com">sanjay.bhargava@tatapower.com</a>
40	Aravali Power Company Pvt. Ltd.	CEO	<a href="mailto:brahmajig@ntpc.co.in">brahmajig@ntpc.co.in</a>	
41	Apraava Energy Private Limited	CEO	<a href="mailto:niraj.gupta@apraava.com">niraj.gupta@apraava.com</a>	
42	Talwandi Sabo Power Ltd.	COO	<a href="mailto:Vibhav.Agarwal@vedanta.co.in">Vibhav.Agarwal@vedanta.co.in</a>	
43	Nabha Power Limited	CEO	<a href="mailto:sk.narang@larsentoubro.com">sk.narang@larsentoubro.com</a>	
44	MEIL Anpara Energy Ltd	President	<a href="mailto:sudheer.kothapalli@meilanparapower.com">sudheer.kothapalli@meilanparapower.com</a>	
45	Rosa Power Supply Company Ltd	Station Director	<a href="mailto:Hirday.tomar@relianceada.com">Hirday.tomar@relianceada.com</a>	
46	Lalitpur Power Generation Company Ltd	Managing Director	<a href="mailto:vksbankoti@bajajenergy.com">vksbankoti@bajajenergy.com</a>	
47	MEJA Urja Nigam Ltd.	CEO	<a href="mailto:hopmeja@ntpc.co.in">hopmeja@ntpc.co.in</a>	
48	Adani Power Rajasthan Limited	COO, Thermal, O&M	<a href="mailto:jayadeb.nanda@adani.com">jayadeb.nanda@adani.com</a>	
49	JSW Energy Ltd. (KWHEP)	Head Regulatory & Power Sales	<a href="mailto:jyotiprakash.panda@jsw.in">jyotiprakash.panda@jsw.in</a>	
50	TATA POWER RENEWABLE	IPP having less than 1000 MW installed capacity (alphabetical rotational basis)	Zonal Head	<a href="mailto:dmahabale@tatapower.com">dmahabale@tatapower.com</a>
51	UT of J&K	From each of the Union Territories in the region, a representative nominated by the administration of the Union Territory concerned out of the entities engaged in generation/ transmission/ distribution of electricity in the Union Territory.	Chief Engineer, JKSPDCL/JKPDD	<a href="mailto:cejkpcl2@gmail.com/sojpd@gmail.com">cejkpcl2@gmail.com/sojpd@gmail.com</a>
52	UT of Ladakh		Chief Engineer, LPDD	<a href="mailto:cepdladakh@gmail.com">cepdladakh@gmail.com</a>
53	UT of Chandigarh		Executive Engineer, EWEDC	<a href="mailto:elop2-chd@nic.in">elop2-chd@nic.in</a>
54	NPCL	Private Distribution Company in region (alphabetical rotational basis)	Head-Commercial	<a href="mailto:ssrivastava@noidapower.com">ssrivastava@noidapower.com</a>
55	Fatehgarh Bhadla Transmission Limited	Private transmission licensee (nominated by central govt.)	AVP-O&M	<a href="mailto:nitesh.ranjan@adani.com">nitesh.ranjan@adani.com</a>
56	NTPC Vidyut Vyapar Nigam Ltd.	Electricity Trader (nominated by central govt.)	CEO	<a href="mailto:ceonvvn@ntpc.co.in">ceonvvn@ntpc.co.in</a>

### **Special Invitees:**

1. Smt. Nandita Gorlosa, Chairman, NERPC & Hon'ble Power Minister, Govt. of Assam, Block D, Ground Floor, Janata Bhawan, Dispur, Assam, 781006 [Email: [nanditagorlosa77@gmail.com](mailto:nanditagorlosa77@gmail.com) ], Telephone no: (0361) – 2237032(O)
2. Shri Gaurav Gupta, Chairperson, SRPC & Managing Director, Karnataka Power Corporation Limited & ACS Energy Department GoK, 240, 2<sup>nd</sup> floor Vikasa Soudha, Bengaluru, Karnataka 560001. [Email: [prs.energy@gmail.com](mailto:prs.energy@gmail.com) ; [acs@karnataka.gov.in](mailto:acs@karnataka.gov.in) ] Tel -08022252373
3. Shri Vishal Kumar Dev, IAS, Chairman, ERPC, Principal Secretary to Govt., Department of Energy, Govt. of Odisha, Bhubaneswar. [Email: [chairman@gridco.co.in](mailto:chairman@gridco.co.in) ] Tel -06742540098
4. Shri P. Dayanand Chairman CSPTCL & Chairman, WRPC, Office of Chairman, Vidyut Seva Bhavan, Danganaya, Raipur 492 013 (C.G.) [Email: [chairmancspc@gmail.com](mailto:chairmancspc@gmail.com)] Tel. 0771 2574000
5. Smt. Rishika Saran, Member Secretary, NPC, Sewa Bhawan, R. K. Puram, New Delhi-66 [Email: [cenpc-cea@gov.in](mailto:cenpc-cea@gov.in)]
6. Shri Deepak Kumar, Member Secretary, WRPC, Plot No- F-3, MIDC Area, Marol, Opp. SEEPZ, Central Road, Andheri (East), Mumbai-40093. [ email: [ms-wrpc@nic.in](mailto:ms-wrpc@nic.in)] Tel - 02228221636
7. Shri Asit Singh, Member Secretary, SRPC, No.29, Race Course Cross Road, Bengaluru-560009. [Email: [mssrpc-ka@nic.in](mailto:mssrpc-ka@nic.in)] Tel -08022287205/9449047107
8. Shri N.S. Mondal, Member Secretary, ERPC,14,Golf Club Road, ERPC Building, Tollygunje,Kolkata-700033. [Email: [mserpc-power@nic.in](mailto:mserpc-power@nic.in)]- Tel 03324239651/9958389967
9. Shri K B Jagtap, Member Secretary, NERPC, NERPC Complex, Dong Parmaw, Lapalang, Shillong-793006. [Email: [ms-nerpc@gov.in](mailto:ms-nerpc@gov.in)] Tel [-03642534077/8652776033](tel:-03642534077/8652776033)
10. Shri Brieflee Lyngkhoi, Chief Engineer, GM Division, CEA, Sewa Bhawan, R. K. Puram, New Delhi-66 [Email: [cegm-cea@gov.in](mailto:cegm-cea@gov.in)]

\*\*\*\*\*

## Attendance of 75th NRPC meeting

Sr.No.	Display Name on Webex	Attendee Email
1	V K Singh, MS, NRPC	ms-nrpc@nic.in
2	Dharmendra Meena NRPC	dharmendra.cea@gov.in
3	Anzum Parwej SE NRPC	anjum.parwej@nic.in
4	NRPC-Reeturaj Pandey	pandeyr.cea@gov.in
5	Praveen, NRPC	praveen.cea@gov.in
6	omkishor, EE, NRPC	omkishor.sahu@gov.in
7	Ravi Kant	ravikant.cea@gov.in
8	Lokesh Agrawal, NRPC	seo-nrpc@nic.in
9	Omprakash NRPC	omprakashrajput.cea@gov.in
10	A N Sar	ansar.ltp@lpgcl.com
11	ABHISHEK KUKREJA-ATL	abhishek.kukreja@adani.com
12	Aman THDC	amannamdev599@gmail.com
13	Amit Hooda APCPL-Jhajjar	amit.hooda01@apcpl.co.in
14	Amit Singh	se_slcd@ptcul.org
15	Amit kumar	amitkumar01@ntpc.co.in
16	Anjan Das, GMGA&C, POWERGRID	anjandas@powergrid.in
17	Ankit Vaish-POWERGRID	ankit_vaish@powergrid.in
18	Ashok	ashokkr@grid-india.in
19	Ashok Kumar GM SJVN Ltd	ashok179@hotmail.com
20	Asim Baig	asimisonet@gmail.com
21	CE LD	se.sold@rvpn.co.in
22	CE TO	cgm.to@uprvunl.org
23	CEPSO UPSLDC	cepso@upslcd.org
24	CTU	jana.sangita@powergrid.in
25	Chief Engineer Hydel, PSPCL	hydeldatapta@gmail.com
26	Chief Engineer SLDC	ce-slcd@pstcl.org
27	DGM	skbaunsiyal@gmail.com
28	Director UPSLDC	directorslcd@upslcd.org
29	Electrical Design HPPCL	ed2hppcl@gmail.com
30	Er. Hare Ram	alberthare.007@gmail.com
31	Er. Rashmi Gautam	ddtech@bbmb.nic.in
32	Er. U. K. Patel, Chandigarh	elop2-chd@nic.in
33	Er.Harpreet Singh Manocha, CESO	ceso@bbmb.nic.in
34	G.S, Budyial Director Operations PTCUL	director.op@ptcul.org
35	Gaurav Malviya	gauravmalviya@grid-india.in
36	H S Hyanki	hitendra0107@gmail.com
37	H S Kaushal	hsk@powergrid.in
38	HPGCL	dysecy@yahoo.co.in
39	HPPTCL	md.tcl@hpmail.in
40	HPPTCL	sahil.verma.tcl@hpmail.in
41	HPSLDC	sehpslcd@gmail.com
42	Hemant Gupta HPPCL	hemant.hppcl@gmail.com
43	Jai Ram Xen SLDC	sesldcop@hvpn.org.in
44	Kashish Bhambhani CTU	kashish@powergrid.in
45	Kavita Parihar	kavita@grid-india.in
46	MD UPCL	md@upcl.org
47	MEIL Anpara-Arun	arun.tholia@meilanparapower.com

48	MK Vats Director	directortechnical@hvpn.org.in
49	Mahavir Prasad Singh	mahavir@grid-india.in
50	Manoj Taunk	manoj.taunk@adani.com
51	N Roy	nroy@grid-india.in
52	NRLDC	shailesh@grid-india.in
53	Narendra Meena, POWERGRID	nkmeena@powergrid.in
54	Navodit Hyanki POWERGRID	navodit@powergrid.in
55	Neeraj Kr. verma	neeraj.verma@energy-sel.com
56	Neeraj Kumar_ POWERGRID NR1	neerajk@powergrid.in
57	PC HPSLDC	sehpsldc@gmail.com
58	PRSYADAV	prsyadav@powergrid.in
59	Prakhar Pathak	prakharpathak321@powergrid.in
60	Punjab SLDC	ase-sldcop@pstcl.org
61	R&A UPSLDC	sera@upsldc.org
62	RASHMI	dirpc@bbmb.nic.in
63	Rahul CTU	rshakya@powergrid.in
64	Rajeev Agarwal SJVN	gmcsosjvn@gmail.com
65	Rakesh Gupta	rakeshgupta@powergrid.in
66	Rohit Kumar Jain POWERGRID	rohit.jain@powergrid.in
67	Rosa power	suvendu.dey@relianceada.com
68	S K Mishra, NHPC	surendramishra@nhpc.nic.in
69	SE UPPTCL	setppss@upptcl.org
70	SJVN C&SO DELHI	gmcsosjvn@gmail.com
71	SK Das, DirectorP&C	director_comm@upptcl.org
72	SLDC haryana	sesldcop@hvpn.org.in
73	Saurabh SharmaAdani	saurabh.sharma@adani.com
74	Shadruddin, NRLDC	shadru786@gmail.com
75	Shafat Ahmed	ahmed.shafat@powergrid.in
76	Sldc	pcpseb@gmail.com
77	Suneel Kumar	suneelppmm@gmail.com
78	T P Verma- CTU	tejprakash@powergrid.in
79	Technical Cell, RVUN	montg.rvun@gmail.com
80	Thakar Dass SE JKPTCL	omcr1jkptcljmu@gmail.com
81	UPCL	it@upcl.org
82	Vishal	v.badlas@powergrid.in
83	Vishal Badlas	v.badlas@powergrid.in
84	Vishal Roy	vishal.roy@powergrid.in
85	Xen CC Nangal	xenccnagl@bbmb.nic.in
86	ed1hppcl	edhppcl2024@gmail.com
87	kuleshwar sahu	kuleshwar@powergrid.in
88	parimal piyush ntpc	parimalpiyush@ntpc.co.in
89	pp chand	purnprakash@grid-india.in
90	pspcl	pcpspcl1@gmail.com
91	sanjay mathur	sanjaymathur0711@gmail.com
92	sesc	sera@upsldc.org
93	vijay kumar nhpc	vijayk@nhpc.nic.in
94	vinita harsh	vinitaharsh@thdc.co.in

Status of action taken on decision 50<sup>th</sup> TCC & 74<sup>th</sup> NRPC meeting

Age nda No.	Agenda	Decision of 50 <sup>th</sup> TCC & 74 <sup>th</sup> NRPC	Status of action taken
A.3	Procedure for approval of Protection Settings by NRPC (agenda by NRPC Secretariat)	Forum advised to deliberate the procedure for approval of Protection Settings in the upcoming PSC meeting and after finalization, the same may be put up for approval of NRPC Forum accordingly.	The procedure has been discussed in the 51 <sup>st</sup> PSC meeting and agenda included in the meeting.
A.4	Standard Operating Procedure (SOP) for Communication audit of Substations (agenda by NRPC secretariat)	NRPC secretariat and NRLDC will hold a joint workshop in July/August, 2024 with all stakeholders of NR on the SOP for detailed understanding of audit process as well as CEA and CERC communication regulations. CEA will also be requested to jointly host the workshop.	Workshop is going to be held on 17.09. 2024.
A.5	Standard Operating Procedure (SOP) for Communication System Outage Planning (agenda by NRPC secretariat)	i) Forum requested CTUIL to confirm within 10 days whether outage planning capability can be developed in U-NMS through a web-based portal. ii) After finalisation of above issues, a joint-workshop will be held with all stakeholders by NRPC	i) CTUIL submitted that no separate communication portal is required. Further, CTUIL confirmed that outage planning capability can be developed in U-NMS through a web-based portal.

Status of action taken on decision 50<sup>th</sup> TCC & 74<sup>th</sup> NRPC meeting

		secretariat, NRLDC and CTUIL.	ii) Workshop is being planned in September 2024.
A.6	Actions for improvement in grid operation (State wise) (agenda by NRLDC)	TCC forum asked HP to also carry out internal audit till the time external audit is carried out at 220/132kV Kunihar Substaion.	HPPTCL commented that 220/132kV Kunihar Substation is owned by HPSEBL. HPSLDC/HPSEBL may apprise the current status.
A.16	Declaration of 400/220/66kV Pooling Sub-Station Wangtoo of HPPTCL as integral part of ISTS system (agenda by HPPTCL)	<p>i) As per CERC Tariff Regulation (2024-29), forum conveyed HPPTCL to approach CEA for the deemed ISTS status.</p> <p>ii) CEA may devise a uniform philosophy for certification of the same along with definition of various related terms mentioned in the clause 93 of CERC Tariff Regulation (2024-29)</p>	<p>On the matter of consideration of non-ISTS lines as ISTS under CERC (Terms and Conditions of Tariff) Regulations, 2024, a letter dated 29.7.2024 was written to Chairperson, CEA.</p> <p>Further, a meeting was chaired by Chairperson, CEA on 31.7.2024 wherein NPC Secretariat, CEA was directed to prepare guidelines for approval process of existing intra-state transmission lines carrying inter-state power.</p> <p>NPC Division, CEA has prepared a draft guideline which is under discussion</p>



Status of action taken on decision 50<sup>th</sup> TCC & 74<sup>th</sup> NRPC meeting

			phase. A standing committee is going to formed in this regard by CEA.
A.17	Shifting of NTPC Rihand stage-III generating station to northern region and opening of 400 kV Singrauli-Anpara line (agenda by NRLDC)	Forum recommended to convene a meeting under chairmanship of MS NRPC in the above matter and the decision of the same would be considered as decision of NRPC.	<p>The meeting was held with concerned stakeholders under chairmanship of MS NRPC wherein it was decided that opening of 400kV Singrauli-Anpara line to control fault levels and shifting of Rihand-III to NR for enhancement of WR-NR transfer capability would be implemented as temporary measure in first week of August without further deliberations.</p> <p>Further, NRLDC has informed that shifting has been completed on 14.08.2024.</p>

Status of action taken on decision 50<sup>th</sup> TCC & 74<sup>th</sup> NRPC meeting

A.18	Approval of Draft SOP regarding Procurement & Installation of ISTS Interface Energy Meter (IEM) (agenda by CTUIL)	Forum decided that Utilities may again submit comment, if any, within one week to CTU and CTU may incorporate the same and finalise SOP without any need of further approval from NRPC forum.	<p>CTUIL informed that after the discussion of 50<sup>th</sup> TCC and 74<sup>th</sup> NRPC meeting, received comments have been incorporated in the SOP.</p> <p>The finalized SOP is available at CTUIL website</p> <p>(<a href="https://www.ctuil.in/uploads/assets/172482773209Final%20SOP%20of%20Meter%20proc%20&amp;%20inst.pdf">https://www.ctuil.in/uploads/assets/172482773209Final%20SOP%20of%20Meter%20proc%20&amp;%20inst.pdf</a>)</p> <p>CTUIL will share the finalized SOP to all the stakeholders.</p>
------	---	---	--

## Minutes of meeting for VOIP Communication System for all regions held in virtual mode (MS-Teams) on 12<sup>th</sup> June 2024

The meeting for VOIP Communication System for all regions held in virtual mode (MS-Teams) on 12<sup>th</sup> June 2024.

The list of participants is attached at *Annexure-I*.

Sr. GM (CTU) welcomed all the participants at the meeting and proceeded with the agenda items. CTUIL emphasised that as the existing VoIP system is under extended AMC till July 2025, so a new system has to be designed and planned by this time. Further CTUIL stated that as the proposed VoIP system shall be PAN India single package, the purpose of this meeting is to make all the functional requirement of the system uniformly in all the region. The agenda of the meeting is attached at *Annexure-II*.

With reference to *Annexure-II* ; 6 . iv) GRID-INDIA requested for discussion on features technical specification etc before optimization of the Cost. CTUIL agreed for the same and discussed all the possible options of design during the meeting and stated that whatever is agreed by the participants in the meeting shall be taken up.

CTUIL shared a presentation (attached at *Annexure-III*) and explained the present and proposed VOIP architecture. The proposed VOIP architecture is a server-based system with 4 level of redundancy through hierarchical control centre servers for each user including RLDC subscribers. The broad aspects and basic features of the proposed VOIP system were explained in detail by CTUIL. Tentative BoQ & Cost of the proposed VOIP system for all regions was presented with three different options in view of cost optimisation.

NRLDC (GRID-INDIA)/ TSTRANSCO enquired about the number of licenses required for each subscriber to achieve 4 level of redundancy in the proposed VOIP system. CTUIL replied that only a single license will be sufficient for each subscriber, regardless of the number of servers they register with, as the proposed VOIP system achieves four levels of redundancy through software configuration and IP mapping and only the capacity of servers shall be enhanced to cater the requirement rather than requiring multiple licenses. Further, GRID-INDIA inquired about the necessity of a hierarchical control centre with multiple levels of redundancy for servers instead of within the utility control centres wise redundancy in line with other ULDC schemes like SCADA, WAMS systems. Further, each Main or Backup Control Centre shall have redundant server (HA Mode) for each function (communication, voice server and NMS etc..). GRID-INDIA also requested for Voice recording System redundancy at each control centre at both application and Hardware level . AEGCL stated that in case of failure of STUs VoIP server the switches (to be procured under VoIP project and connected to VoIP server) which will be connected to STUs FOTE and ISTS FOTE, the VoIP traffic from state GSS will be routed to RLDC VoIP server and accordingly redundancy of VoIP services will be maintained. AEGCL further emphasized that with such design aspect redundant STU VoIP server may not be required . CTUIL replied that this VOIP system is operational PAN India and is instrumental in managing the regional and national grids through voice commands exchanged among various control centres. This calls for a high redundancy especially for the remote stations under central and state sector. Hence 4 level redundancy for all remote subscribers is

very much required. However, CTUIL stated that it was already decided in previous meetings with all constituent of all regions.

SRLDC (GRID-INDIA) enquired about whether the multiple level of redundancy planned is for Voice Recording Failure / application-level failure or supply failure or communication channel failure etc. at SLDC and its routing to the next level i.e RLDC. CTU explained that at SLDC level both hardware and channel level redundancy for STUs subscribers is considered but at RLDC level only hardware level redundancy for these subscribers is envisaged. In the similar fashion central sector and local subscribers of RLDC have both hardware and channel level redundancy but at NLDC level only hardware level redundancy is considered. .

TSTRANSCO further enquired about the voice recording backup of STUs at RLDC level. CTUIL replied that voice recording is limited to state level only as STUs/SLDC have already stated in the various meetings of all regions that their voice recording backup should not be kept at RLDC/other utility.

TANTRANSCO enquired about the number of servers whether single server will be used for communication, voice and NMS functions or separate for all functions. CTUIL replied that a set consisting of 3 separate servers shall be used at each control centre. This was discussed and agreed in various meetings of all regions. TANTRANSCO further asked that whether exchanges will be required along with servers in the proposed VOIP system. CTUIL replied that exchanges are not required in the proposed VOIP system. TANTRANSCO asked whether any special feature are required in VOIP phones to connect with RLDC. CTUIL replied that no extra feature is required in VOIP phones to connect with RLDC. TANTRANSCO asked that whether VOIP phones in the upcoming Scheme can connect with the existing exchange of STUs. CTUIL replied that they have discussed the same with the OEMs and it was clarified that once the existing exchange gets integrated with proposed VoIP system, all subscribers of existing exchange shall also be registered in upcoming system. So the existing subscribers can be connected in this manner. TANTRANSCO asked that whether UPS are considered with servers. CTUIL replied that UPS are not considered in the scope of the upcoming VOIP scheme. TANTRANSCO informed that they will revise their inputs and provide to CTUIL. SRLDC (GRID-INDIA) requested to explore the architecture/solution of other OEMs also for better participation and competition. CTUIL stated that proposed solution is complied by many OEMs and the cost of other prospective vendors is also expected soon and shall be taken into consideration in final proposal at RPC.

WRLDC (GRID-INDIA) enquired about the connectivity of VOIP phone with both (Main & Backup Control centre) and also informed that RLDC shall be operating as Main I and II Control Centre philosophy with Active-Active Mode and remote subscriber call shall be routed to acting Main control Centre by VOIP system itself based on the designated as acting Main Control Centre. This feature shall be incorporated in the detailed feature by the implementing agency. CTUIL replied that there are two different cards in the FOTE, one reports to main control centre and other reports to Backup Control Centre or Main II Control Centre. Through a switch VOIP phone is connected to the two different ports in the FOTE which are reporting to both main and backup control centre. Two different channels will be in active- active mode. WRLDC (GRID-INDIA) asked whether routers are considered in the scope of this scheme. CTUIL replied that routers are not required as present communication system is TDM based. Further CTUIL clarified that the L3 switches being used which shall work like routers.

WRLDC (GRID-INDIA) also enquired whether cyber security audit is considered in the scope of AMC. CTUIL replied that revised cost estimate with cyber security audit cost will be shared. WRLDC (GRID-INDIA) also requested to make VLANs for different channels for seamless operation. CTUIL replied that these aspects shall be covered under detailed engineering while implementation.

GRID-INDIA emphasized that managing a large network in a flat manner (Layer 2) would be extremely challenging for troubleshooting network issues, particularly network loops, which are common due to the involvement of multiple stakeholders across thousands of sites. This is because the network has a massive broadcast domain, this issue is also observed in the existing VOIP system which is designed back in the year 2013. To mitigate this, routers/firewalls at the SLDCs/RLDCs and NLDCs levels should be implemented with Access Control Limits for each utility Electronic Security Boundary (ESB) in line with the CEA Cyber Security Guidelines 2021. GRID-INDIA further, the network should be segmented using VLANs with proper subnetting to prevent lateral movement and ensure need basis logical reachability among sites and control centres. GRID-INDIA has also informed that this suggestion is given to CTUIL from SRLDC as part of comments in format shared by CTUIL for sizing of the Exchange.. CTUIL stated that the detailed specifications shall be prepared by the implementing agency in consultation with stakeholders and shall be in accordance with the CEA cyber security guidelines 2021.

NERLDC (GRID-INDIA) requested to include various aspects for AMC period such as Patch Management of Servers, Firewalls, Switches and other devices of the system. Moreover, it is requested that responsibility of complying with cyber security guidelines and advisories during the maintenance phase should be of the implementing agency the system and it should in scope of AMC. GRID-INDIA suggested to include the scope work for AMC in line with the other ULDC Schemes like SCADA/EMS upgradation. CTUIL clarified that such aspects shall be covered in the bidding documents prepared by the implementing agency in consultation with stakeholders.

GRID-INDIA also requested for Provision (Optional Rate) of integration of all VOIP /phones etc with 3<sup>rd</sup> Party Voice Recording System during contract period . CTUIL stated that such feature is not envisaged in the present scope because any integration with 3<sup>rd</sup> party equipment /system may lead to cyber threats.

ERLDC (GRID-INDIA) enquired whether voice recording shall be stored at hot standby redundant the servers at each control centre. CTUIL replied that recording will be stored in the server through which call is connected and both main and backup servers will get synchronised periodically. CTUIL also clarified that if both main and backup servers at SLDC are down even then also, remote subscribers can connect with RLDC level server, but voice recording shall be restricted to SLDC servers due to administrative reasons. ERLDC (GRID-INDIA) also asked that NMS server that will be used here is for VOIP or complete communication system. CTUIL replied that NMS server proposed here is solely for proposed VOIP system.

ERLDC (GRID-INDIA) suggested that two number of VoIP phones along with two POE switches can be considered at remote subscriber end for better redundancy. CTUIL replied that such arrangement is not available with switching of 2 phones along-with POE switches. If

multi-port single POE switch is used for switching of the two phones may result in single point failure of the combined switch, hence the same will not result in better design. ERLDC (GRID-INDIA) requested to include the complete cabling at control centres in the scope of the scheme. CTUIL replied that local cabling at control centre level is included in the scope.

ERLDC /POWERGRID requested to include remote site installation also in the scope of this scheme. CTUIL stated that it will increase the cost further so if all constituents agree, this can be included. WRLDC & NRLDC (GRID-INDIA) informed that remote installation may not be included in the scope of this scheme but POWERGRID, ERLDC & NERLDC were of view that remote installation should be included. CTUIL stated that after taking cost of remote installation from OEMs, revised tentative cost estimate will be shared with the MoM. NERLDC MePTCL/ERLDC also requested to consider cordless VOIP phones for their remote generation plants. CTUIL replied that they have explored this aspect with various OEMs/suppliers. The OEMs suggested that a local tower will be required connecting the wireless users. This is not a feasible solution for the stations and involves high cost as compared to the normal cordless phones. In view of this this aspect is not advisable to be adopted with the said scheme.

Maha TRANSCO raised query that they do not have separate media from all substations which can provide redundant path upto SLDC. CTUIL suggested Maha TRANSCO to take up this as a separate agenda in the TeST meeting of the region. Maha TRANSCO further asked that whether existing Alcatel phones will be utilised in the upcoming scheme. CTUIL replied that existing Alcatel phones are proprietary in nature so they may not be used in the upcoming VOIP scheme. Maha TRANSCO asked about the configuration of despatcher console. CTUIL replied that configuration of despatcher console shall be taken care at the time of detailed engineering.

NLDC asked regarding the provision of international exchange for cross border links. CTUIL replied that a separate server set (with Voice, NMS and recording) with desired capacity shall be considered for the NLDC/Backup NLDC and RLDCs shall be Remote Subscribers for cross border voice communications. Tentative Cost of international exchange along with phones shall be included in the cost estimate shared with the MoM.

HVPNL also raised query regarding integration of their exchange. CTU replied that in case of integration, only servers are required at control centres as suggested by the OEMs, and the cost for integration of existing exchange will be added in the cost estimate shared with the MoM. HVPNL also asked the basis of cost estimate. CTUIL replied that the tentative cost is based on the budgetary quotes received from prospective OEMs/supplier.

MePTCL raised query regarding redundancy of fibre paths for FXS & FXO i.e. 2W phones.. CTUIL asked MePTCL to take up separate agenda in this regard in the TeST meeting.

AEGCL asked that if both switch and FOTE fails at a node then how it will route to SLDC, CTUIL explained that if both the switch and FOTE fails than it will not route to SLDC/RLDC.

POWERGRID asked whether POE switch and DC-AC converter are required for remote as well as local subscribers. CTUIL replied that POE switch and DC-AC converter are required only for remote sites and for remote sites installation, remote support shall be provided by OEM/vendor for installation purpose. AEGCL also informed that the switches required at both GSS

end and SLDC/RLDC end may be considered with dual source DC supply POWERGRID also suggested to take DC (48V) operated POE switch with 2 sources of supply instead of DC-AC converter. CTUIL replied that after taking cost of such DC operated POE switch, revised tentative cost estimate shall be shared with the MoM.

NERLDC (GRID-INDIA) requested that the inclusion of various minor components such as Rack for PoE Switches, MCB for DC connections etc., should also be considered in the project. CTUIL responded that the same will be done during detailed engineering by implementing agency.

NERLDC (GRID-INDIA) requested that PoE switch with AC Supply should be provided at SLDCs, RLDCs and NLDCs also for powering up the IP based local subscriber of LDCs, as connecting the individual phones with power adapter will not be feasible at all the desks. SRLDC (GRID-INDIA) also seconded the fact that PoE with AC Supply switch is very much required for LDCs. CTUIL clarified that covering of this feature shall be costlier than providing the adapters for the phones at these control centres which are already equipped with UPS/ battery banks/ DG Set hence it is not recommended. Further at the time of deliberation of final technical specification with the stakeholders by implementing agency same shall be taken care in agreement with all stakeholders.

KSEB enquired that two phones can be considered if one phone is engaged, call can be made on the other phone. CTUIL stated that overriding facility is considered in the upcoming VOIP system.

APTRANSCO enquired regarding sharing of cost for the server required for the integration of existing exchange and how the cost will be shared among various utilities. CTUIL informed that project shall be under Regulated Tariff Mode (RTM) and cost will be shared as per CERC sharing of ISTS charges regulation 2020.

MS,SRPC suggested that tentative cost breakup of phones at STU locations may be worked out and during RPC agenda same shall be presented accordingly. CTUIL agreed for the same and shall provide the Central sector (CS) and State sector (SS) cost and the cost shall be borne by the constituent as per the CERC Regulation.

**Following was concluded in the meeting:**

1. Draft Technical Specifications shall be prepared by implementing agency in which the scheme details along with BoQ shall be shared with all stakeholders before finalization..
2. Provision of separate international exchange server with phones to be considered.
3. Remote location cabling and installation shall be included in the scope
4. Cordless VOIP phones for ER/NER is not advisable with said scheme..
5. POE switch with dual DC input source shall be considered as per site condition and DC-AC converters shall be deleted.
6. Cyber security audit cost of VoIP system shall be considered.
7. Central Sector (CS) and State Sector (SS) wise cost breakup shall be shared.
8. Proposed System shall comply with the CEA Cyber Security Guidelines 2021.

Revised Cost estimate is prepared after incorporating inputs received from the utilities and is attached at **Annexure-IV**

**Meeting ended with vote of thanks.**



## Annexure -I

### List of Participants

Sr.No	Name	Designation	Organisaation	Mobile no.	Email-Id
1	Asit Singh	MS	SRPC	9449047107	mssrpc-ka@nic.in
2	Meka Ramakrishna	SE	SRPC	9448298345	seprotnsrpc-ka@nic.in
3	Priyam Srivastava	Dy.Director	CEA		priyam_cea@nic.in
4	Priyanka Patel		NRPC		
5	Sh.Praveen		NRPC		
6	Representative from ERPC		ERPC		
7	H.S.Kaushal	Sr.GM	CTU	9599291535	hsk@powergrid.in
8	Shiv Kumar Gupta	Sr.DGM	CTU	7007496879	shivkumar@powergrid.in
9	Tej Prakash Verma	DGM	CTU	9650598191	tejprakash@powergrid.in
10	Kalpna Shukla	DGM	CTU	9650293198	kalpanashukla@powergrid.in
11	Kaushal Suman	CM	CTU	7042396702	k.suman@powergrid.in
12	Prakhar Pathak	Engineer	CTU	8953109167	prakharpatak321@powergrid.in
13	Abhay Kumar	Engineer Trainee	CTU	6397420407	abhay3031@powergrid.in
14	Ankur Gulati	DGM	Grid-India NRLDC	9869080336	ankurgulati@grid-india.in
15					
16					
17	Sakal Deep	AM	NERLDC, GCIL	9774528218	skldeep@grid-india.in
18	Saugato		NERLDC, GCIL		
19	Shakti Mayank Singh	Engineer	NERLDC, Grid India	8299085576	shaktimayank@grid-india.in
20	Rakesh Kumar Singh		ERLDC		
21	L.Muralikrishna		ERLDC		
22	Samar chandra De		ERLDC		
23	ROSHAN JAISWAL	ENGINEER	WRLDC	9007184569	roshanjaiswal@grid-india.in
24	S K Chandrakar	GM	WRLDC	9433041800	sanjeevchandrakar@grid-india.in
25	Koti Naveen	Manager	WRLDC	9820769673	kotinaveen@grid-india.in
26	Raj Kumar		SRLDC		
27	Harish		SRLDC		
28	L Sharath chand		SRLDC		
29	Kapil Gupta	DGM	POWERGRID		
30	Narendra Kumar Meena	DGM	POWERGRID	9810082410	nkmeena@powergrid.in
31	Vishal Badlas	Manager	POWERGRID		
32	Dileep kumar rathore		POWERGRID		
33	Mayank dhar shukla		POWERGRID		
34	Biplo Sarkar		POWERGRID		
35	Representative from POWERGRID SR-1				
36	BASUDEO MAHATO	Manager (SCADA)	SLDC, JUSNL JHARKHAND	8051084040	Uldc.jusnl@gmail.com basu18may@gmail.com
37	Yomonmi Iakai	AEE	SLDC Meghalaya	9402133552	iakaiyomon@gmail.com
38	H.Lalruatkima	SE	SLDC Mizoram	9862925462	sldc_mizoram@rediffmail.com
39	RAJESH KUMAR	MANAGER(COMMUNICATION)	DVC	7782939051	RAJESHKUMAR@DVC.GOV.IN
40	Pradhan Soren	DGM(Commn.)	DVC	8972408129	pradhan.soren@dvc.gov.in
41	SHAMBHU DAS	Sr. Manager(Communication)	Damodar Valley Corporation	7980161164	shambhu.das@dvc.gov.in
42	K N Srinivasan	EE EPC3 D P&C	TANTRANSCO LTD	9445396708	eeepc3@tnebnnet.org
43	C.Deepa		TANTRANSCO LTD		
44	Soumyakanta Ray	Sr.GM(Telecom)	OPTCL	9438907477	cgm.tel@optcl.co.in
45	K P Rafeeqe	Executive Engineer	KSEBL	9847377496	rafeeqkseb@gmail.com
46	B ELUMALAI	AEE COMMUNICATION/SRIPERUMBUDUR	TANTRANSCO	9445396751	aeccspr@tnebnnet.org
47	Mang Kyrpang War	Executive Engineer,SM,SLDC Meghalaya	MePTCL	9774012496	eesmldcmeg@gmail.com
48	sh.Carlos		MePTCL		
49	Er. Manjit Singh	Addl.SE	PSTCL	9646118024	srxen-coc-pta@pstcl.org
50	Sh.Ramesh		TSTRANSCO		
51	Arup Sarmah		AEGCL		
52	K.Sridhar	Executive Engineer	APTRANSCO		
53	Representative from BBMB	Xen	BBMB		
54	Pongmei		SLDC Nagaland		
55	Representative from SLDC Panipat	Xen	SLDC Panipat		
56	N.K Patel	SE	GETCo		
57	Representative from SLDC Chattisgarh		SLDC Chattisgarh		
58	Niranjan Dalal		MahaTRANSCO		

# Annexure-II

## Agenda for combined meeting

### VOIP System (Hotline speech communication)

1. Hot Line Speech Communication System (VOIP based Exchange system) was implemented in 2016 by POWERGRID in all the five regions for faster communication due to unavailability of dedicated **PAN India** speech communication between NLDC, RLDCs, SLDCs, important state and ISTS substations/generators. The said PABX was implemented by M/s Orange through Alcatel Lucent as OEM.
2. In the 67th NRPC meeting, POWERGRID representative stated that the scheme executed by M/s ORANGE was with a provision of AMC of 7 years as part of the contract and the same is expiring in July' 2023 for most of the sites.
3. AMC of the same was extended and approved in the 67th NRPC for further 2 years upto July'25. After July'25 there is no support shall be extended by Alcatel (OEM).
4. In 67<sup>th</sup> NRPC Meeting, MS, NRPC advised CTU to plan upgradation/ new system in view of expiry of AMC of existing VOIP System in July'25.
5. As life of existing system is 15 years as per CERC tariff petition, POWERGRID shall file petition to CERC for revised depreciation, after which new project shall be awarded.
6. CTU has discussed the requirement with various VOIP system suppliers and proposed VOIP System Architecture is attached at **Annexure-I**.

Salient features of proposed VOIP system are given below as below:

- i. Server based architecture:  
Multiple level (4) of redundancy as compared to no redundancy in existing system.
- ii. SLDC & RLDC servers has Local (Central Sector phones) and Remote (Substation, generators) Phone support. However, at NLDC only local phone support will be there.
- iii. Power over ethernet switches proposed for all VOIP phone at stations for redundancy and powering the phones. In place of POC injectors, Switches with POE output are considered (additional DC to AC convertor will be required as switches operates at AC voltage)
- iv. For cost optimization single servers are proposed for Voice, NMS & Call Recording.
- v. There are no duplication of licenses for backup servers.

- vi. Server size and software has been considered by taking future requirement of phones.
  - vii. Support for integration of future exchange of other utilities considered (their control centres).
  - viii. NMS for adding/ deleting users shall be provided at RLDC/ SLDC levels
  - ix. Operator console shall be provided to manage calls at RLDC/SLDC
    - x. Call recording features shall be provided at RLDC & SLDC level
  - xi. VOIP, Digital, Analog, Four Wire E&M (at PLCC locations) phones are considered
  - xii. Video Phones at RLDC/ SLDC for Senior officials
  - xiii. Sufficient numbers of licenses to cater future RE/ ISTS/ ISGS/ IPP and STU substations locations. The licenses for present and future requirement of the phones are considered under the scope of project, however phones for present requirement only shall be procured.
  - xiv. Firewall at control centres is considered
  - xv. Exchanges are not required at STUs where STUs have their own existing exchange, only integration shall be required which can be done through SIP/PRI lines
  - xvi. One Exchange for international connection at NLDC main and Backup of NLDC (25 lines) to be decided.
  - xvii. 1 year of warranty with 6 year of AMC which can be extendable up to 3 years
  - xviii. VOIP phones are to be installed at Control Centre Level, at Stations levels phones/ gateways to be handed over to utilities and remote support shall be provided.
  - xix. Cat-6 cable of 100 meter has been considered for remote locations.
7. In this regard inputs were received from the utilities in the various meetings of CPM/ TeST of all five regions. For the utilities those have provided inputs we have considered the same in the cost estimate purpose. For the utilities where inputs are not available the present exchange license sizes have been considered for the cost estimate purpose.
  8. Tentative cost estimate based on the budgetary quotation from prospective suppliers has been obtained and shall be presented during the meeting.
  9. It is proposed that being a Nation wise project, the total cost of five regions including NLDC shall be put up in all five regions RPCs/NPC thereafter, getting views of RPCs scheme shall be put in the NCT for approval.

**Tentative Region wise Cost estimates:**

S. No.	Region	Tentative Cost (in Cr.)
1	NR	27.61
2	SR	24.71
3	WR	21.61
4	ER	16.69
5	NER	17.71
6	NLDC	2.63
<b>Grand Total</b>		<b>110.96</b>

# Annexure-I

## Proposed VOIP System Architecture:

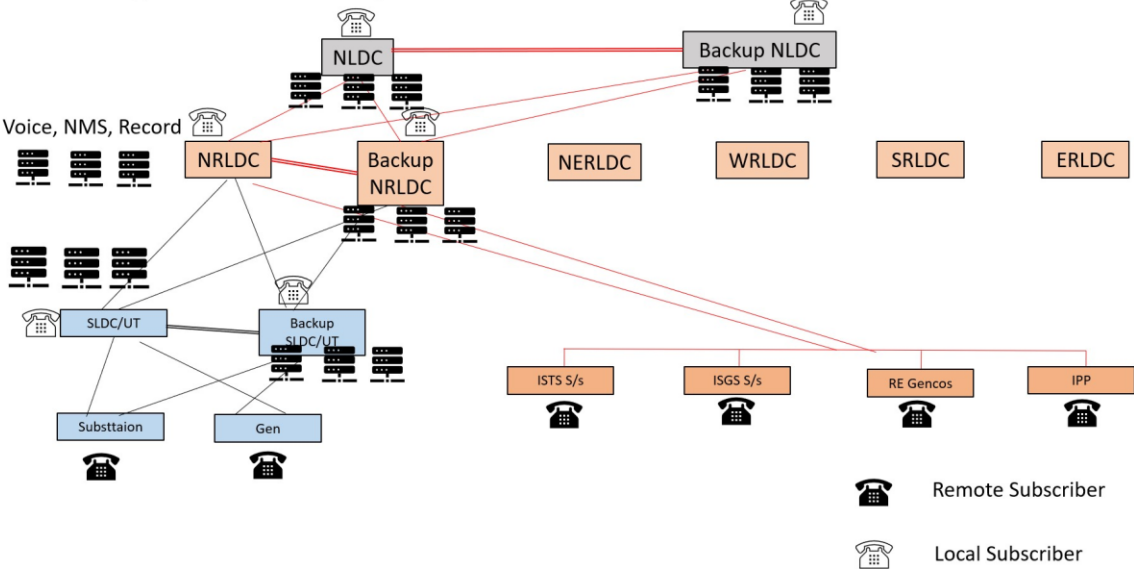

Combined CPM  
VOIP  
Communication  
System  
12.06.2024



## SCHEMATIC DIAGRAM FOR HOT LINE SPEECH COMMUNICATION (COMPUTER DIALLING) SYSTEM FOR GRID OPERATION

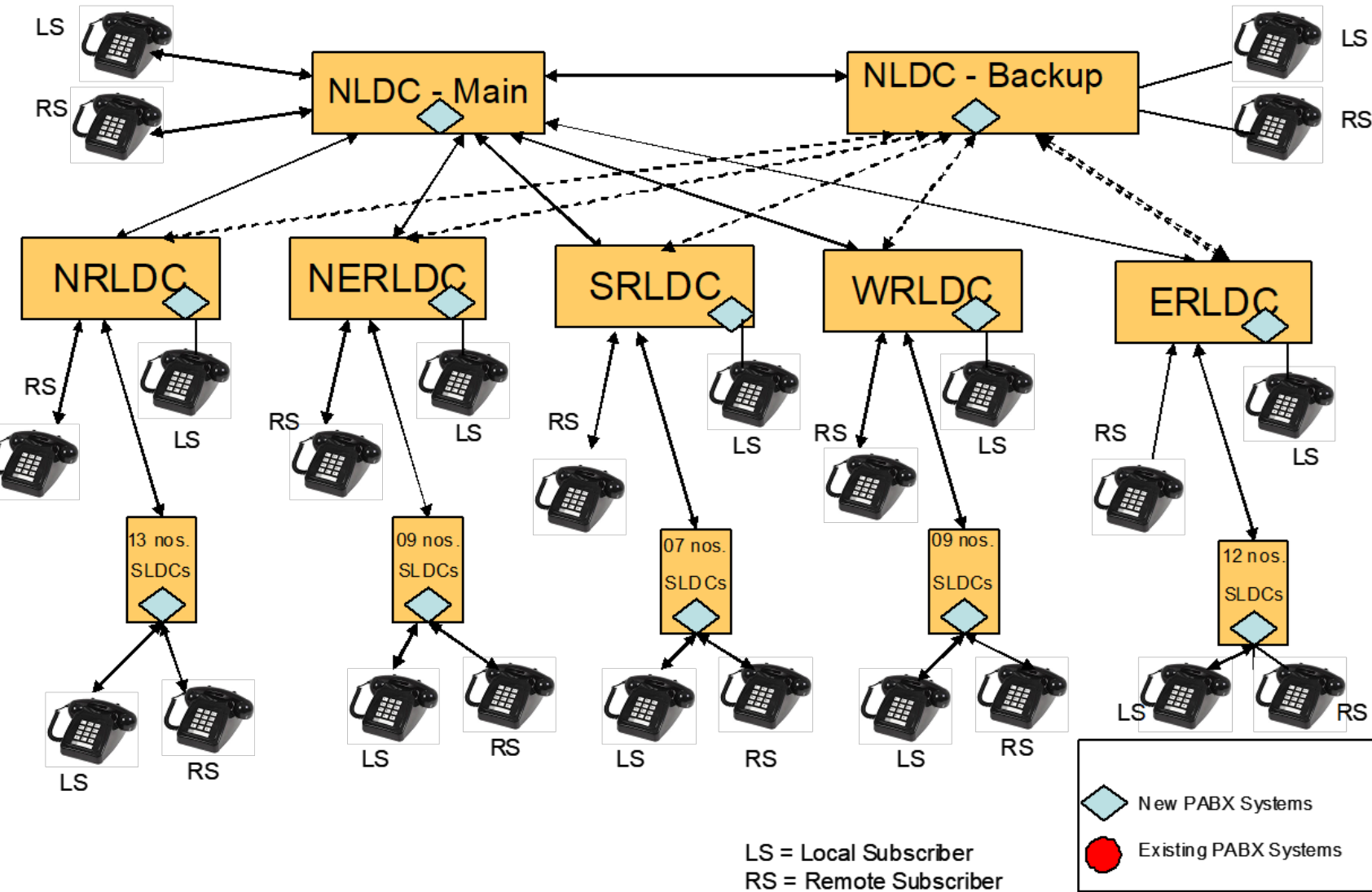

# Present Hotline PABX Architecture

# Proposed VoIP System Architecture



# Proposed VOIP System Architecture:

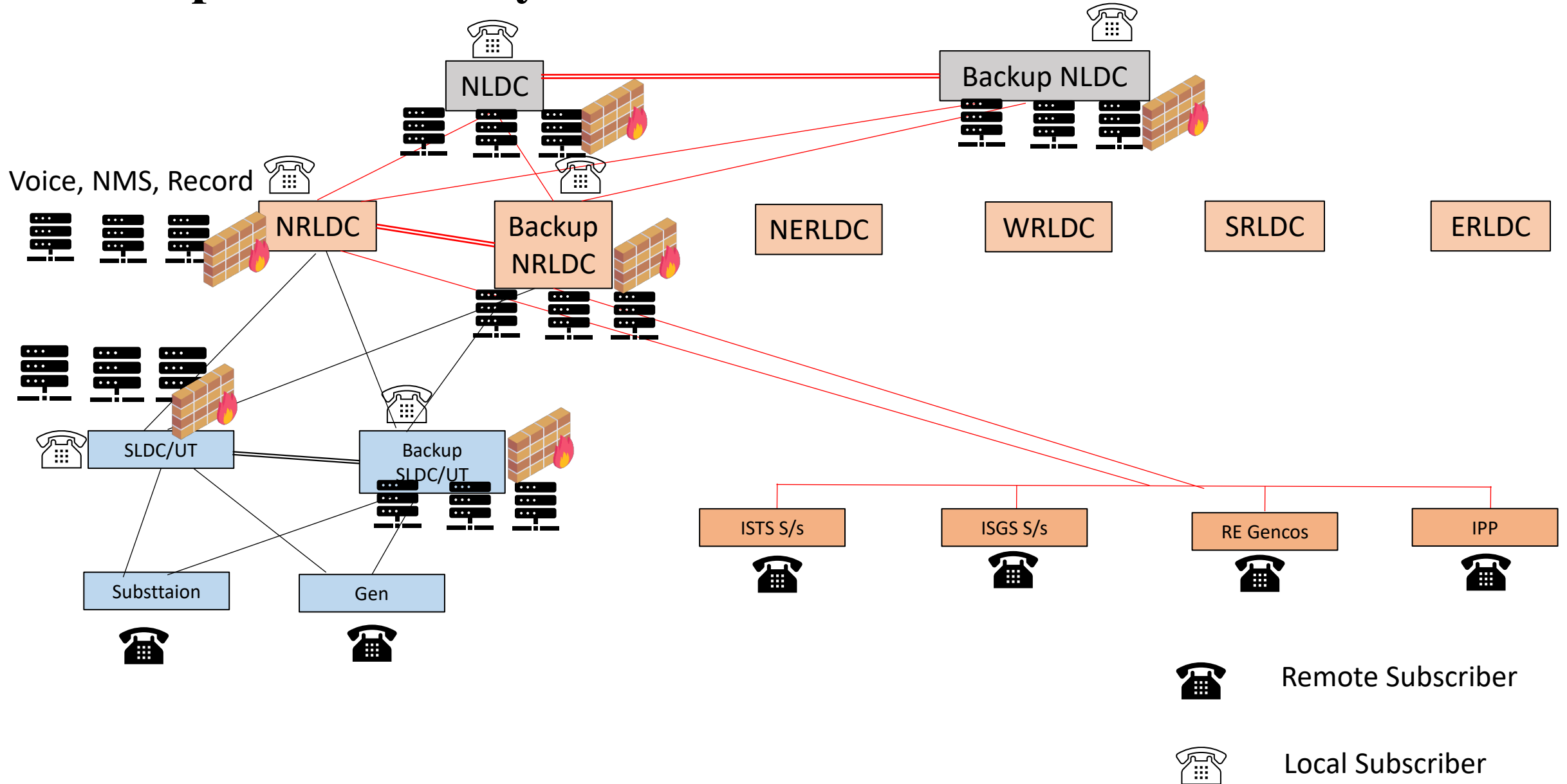



# Design Aspects



Each control center (Main & Backup) has 3 Servers

## Voice NMS Recording

The main and its backup servers of the control centres (SLDC, RLDC & NLDC) shall be placed respectively at their physical locations.



Each Remote Subscriber of STU/UT shall be registered at four voice servers i.e. remote subscriber of SLDC will be registered at main SLDC, backup SLDC, Main RLDC and Backup RLDC in view of redundancy.

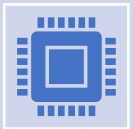

Call recording servers shall be provided at all main and backup control centres and will be sync through network periodically.



Configuration and management servers (NMS server) shall be provided at both main and backup SLDC, RLDC, NLDC individually.

# Design Aspects

- The redundancy of subscriber channels between SLDC and RLDC shall be met by two discrete wide channels (similar to ICCP channel) containing the data of all SLDC subscribers. Similar is the case with backup SLDC and RLDC.
- The voice recording of subscribers of each utility shall be limited to that utility control centres only.
- In case communication link failed between subscriber to main SLDC server, subscriber will be switched automatically to the already active backup server and if both main and backup SLDC servers failed, subscriber will be connected with the already active Main RLDC server.
- Hardware level redundancy of SLDC servers has been considered at RLDC level.
- In case of central sector subscribers, similar redundancy has been planned for RLDC and NLDC level.

# Design Aspects – Contd.

- VOIP as well as analog both phones are considered at SLDC, RLDC, NLDC locations.
- Provision of Video phones for higher officials
- POE based switched at remote site for power supply to IP phones
- DC-AC converter for remote sites.
- Trunk/SIP lines integration is considered for outside network calls on mobile or another landline and the cost towards this shall be billed and settled by the respective utility.
- (4 wire E&M) phones are also planned through PLCC integration for few locations at SLDC level
- Integration with proposed Exchanges is kept at RLDC/ SLDC
- For Cyber Security Firewall are considered at each (main and backup) Control Centre
- Sizing of servers has been done as per the no. of subscribers at each control centres
- Cat-6 cable (100m) has been considered at each remote locations for VOIP phone/Gateway connection with FOTE

# Features in Proposed VOIP system

- All Control Centres (NLDC, RLDCs and SLDCs) shall be provided with dispatcher console with advanced features such as touch screen dialing, directory sorting, user friendly display etc. The directory display in touch screen shall be configurable.
- A flexible closed numbering scheme shall be developed. The numbering scheme adopted shall take into account future network expansion so that introduction of new exchanges and subscribers shall require configuration of only those exchanges directly involved in the expansion.
- The proposed VOIP system is a PAN India system where any user can call to any user in Nation Wide.
- It will be possible to intrude on and/or disconnect ongoing calls of lower priority if free trunks are not available or if the called subscriber is engaged.
- Seamless network wherein existing multi-vendor Exchange/VOIP system of utilities are networked together.
- The equipment shall have flexibility to add/delete/modify Service Features and other facilities without requiring extensive modification and service discontinuity.

SIP based open sources VOIP phones can be integrated

# Cost & BoQ of Proposed VOIP System for all regions (Option-1)

Region	Server Set		Phone (No.)		POE Switch	DC-AC Converter	Cat 6 cable (100m set)	NGFW (No.)	Grand Total (with AMC) (in Crs.)
	Main	Backup	VOIP	Analog Phone (including gateway)					
<b>NR</b>	10	10	2479	951	2368	2368	2368	20	<b>₹ 27.61</b>
<b>SR</b>	7	7	2875	252	2517	2517	2517	14	<b>₹ 24.02</b>
<b>WR</b>	8	6	2192	1044	2092	2092	2092	14	<b>₹ 21.62</b>
<b>ER</b>	7	7	1079	1059	942	942	942	14	<b>₹ 15.96</b>
<b>NER</b>	8	8	1424	619	1311	1311	1311	16	<b>₹ 19.19</b>
<b>NLDC</b>	1	1	42	400				2	<b>₹ 2.63</b>

**Grand Total**

**₹ 110.62**

# Cost & BoQ of Proposed VOIP System for all regions (Option-2)

Region	Server Set		Phone (No.)		POE Switch	DC-AC Converter	Cat 6 cable (100m set)	Remote VOIP Phone with POE injector	NGFW (No.)	Grand Total (with AMC) (in Crs.)
	Main	Backup	VOIP	Analog Phone (including gateway)						
NR	10	10	2479	951	0	0	4736	4736	20	₹ 18.65
SR	7	7	2875	252	0	0	5034	5034	14	₹ 15.23
WR	8	6	2192	1044	0	0	4184	4184	14	₹ 13.53
ER	7	7	1079	1059	0	0	1884	1884	14	₹ 12.41
NER	8	8	1424	619	0	0	2622	2622	16	₹ 14.23
NLDC	1	1	42	400					2	₹ 2.63

**Grand Total ₹ 76.71**

# Cost & BoQ of Proposed VOIP System for all regions (Option-3)

Region	Server Set		Phone (No.)		POE Switch	DC-AC Converter	Cat 6 cable (100m set)	Remote VOIP Phone with POE injector	NGFW (No.)	Grand Total (with AMC) (in Crs.)
	Main	Backup	VOIP	Analog Phone (including gateway)						
NR	10	10	2479	951	0	0	4736	4736	0	₹ 15.80
SR	7	7	2875	252	0	0	5034	5034	0	₹ 13.10
WR	8	6	2192	1044	0	0	4184	4184	0	₹ 11.54
ER	7	7	1079	1059	0	0	1884	1884	0	₹ 10.42
NER	8	8	1424	619	0	0	2622	2622	0	₹11.96
NLDC	1	1	42	400						₹ 2.35
<b>Grand Total</b>										<b>₹ 65.2</b>

Thank you

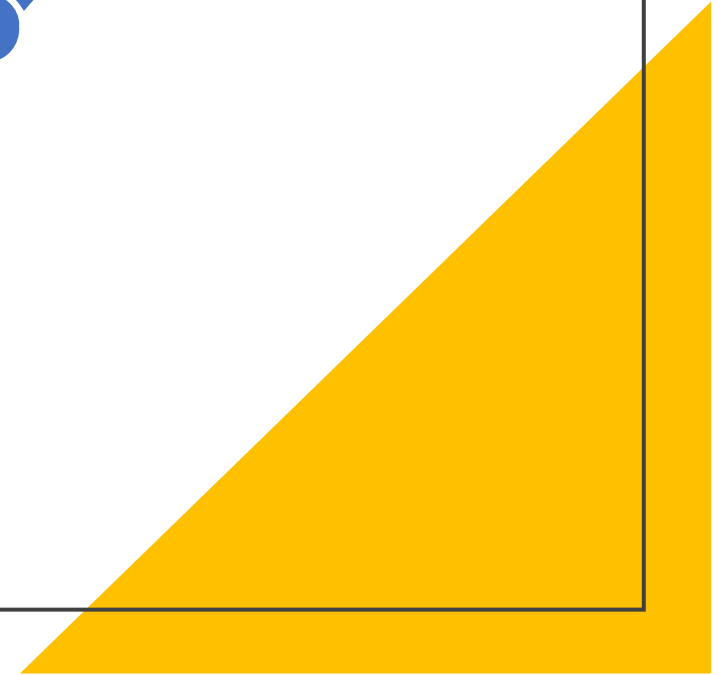



# **Annexure-IV Revised Cost estimate**

# Tentative Cost & BoQ of Proposed VOIP System for All regions CS +SS(Option-1 revised)

Region	Server Set		Phone (No.)		POE Switch (with dual DC)	Cat 6 cable (100m set)incl. installation	NGFW (No.)	Grand Total (with AMC) (in Crs.)
	Main	Backup	VOIP	Analog Phone (including gateway)				
<b>NR</b>	10	10	2479	951	2368	2368	20	₹ 34.3227
<b>SR</b>	7	7	2875	252	2517	2517	14	₹ 32.8099
<b>WR</b>	8	6	2022	1044	1882	1882	14	₹ 26.1236
<b>ER</b>	7	7	1032	1093	822	822	14	₹ 17.8878
<b>NER</b>	8	8	1599	326	1138	1138	16	₹ 22.0682
<b>NLDC</b>	1	1	42	400	0	0	2	₹ 2.6325
<b>Intl.</b>	1	1	29	0	0	0	2	₹ 1.209754
Cyber Audit of complete VoIP network for 7 years								<b>₹ 2.8</b>

**Grand Total**

**₹ 139.85**

# Tentative Cost & BoQ of Proposed VOIP Syst. for NR SS(Option-1)



State	Server Set		Phone (No.)		POE Switch (with dual DC)	Cat 6 cable (100m set)incl. installat ion	NGFW* (No.)	Grand Total (with AMC) of SS (in Crs.)
	Main*	Backup*	VOIP	Analog Phone (including gateway)				
SLDC DTL, Minto Road	1	1	226	0	193	193	2	1.61
SLDC,RRVPNL, Heerapura	1	1	24	49	0	0	2	0.081
SLDC,BBMB, Chandigarh	1	1	182	116	182	182	2	1.57
SLDC,PSTCL, Patiala	1	1	203	8	197	197	2	1.64
SLDC,HPSEBL, Shimla	1	1	182	164	182	182	2	1.59
SLDC, UPPTCL, Lucknow	1	1	820	0	800	800	2	6.49
SLDC, HVPNL, Panipat	1	1	0	0	0	0	2	0
SLDC, JKPTCL, Jammu	1	1	182	148	182	182	2	1.58
SLDC, PTCUL, Dehradun	1	1	182	116	182	182	2	1.57

\* This BoQ pertains to Central Sector(CS) and has not been included in the cost.

**Grand Total**

**₹16.14**

# Tentative Cost & BoQ of Proposed VOIP System for SR SS (Option-1 revised)

Region	Server Set		Phone (No.)		POE Switch (with dual DC)	Cat 6 cable (100m set)incl. installation	NGFW* (No.)	Grand Total (with AMC) of SS (in Crs.)
	Main*	Backup*	VOIP	Analog Phone (including gateway)				
KSEB, Kalamessary	1	1	563	0	546	546	2	4.49
TSTRANCO, Hyderabad	1	1	862	20	800	800	2	6.73
KPTCL, Bangaluru	1	1	2	0	0	0	2	0.0015
Puducheery	1	1	75	64	41	41	2	0.50
TANTRANSCO, Chennai	1	1	141	18	130	130	2	1.14
APTRANSCO, Vijaywaya	1	1	0	0	0	0	2	0.00

\* This BoQ pertains to Central Sector(CS) and has not been included in the cost.

**Grand Total**

**₹ 12.86**

# Tentative Cost & BoQ of Proposed VOIP System for WR SS (Option-1 revised)

Region	Server Set		Phone (No.)		POE Switch (with dual DC)	Cat 6 cable (100m set)incl. installation	NGFW* (No.)	Grand Total (with AMC) of SS (in Crs.)
	Main*	Backup*	VOIP	Analog Phone (including gateway)				
SLDC,Panjim/Madgaon	1	1	100	84	100	100	2	0.89
SLDC,Bhopal	1	1	440	220	400	400	2	3.40
SLDC,Raipur	1	1	400	148	400	400	2	3.34
SLDC,Vododara	1	1	200	244	200	200	2	1.77
SLDC,Mumbai	1	1	182	244	182	182	2	1.62
SLDC Daman & Diu	1	0	50	84	50	50	1	0.49
SLDC DNH	1	0	50	0	50	50	1	0.40

\* This BoQ pertains to Central Sector(CS) and has not been included in the cost.

**Grand Total**

**₹ 11.92**

# Tentative Cost & BoQ of Proposed VOIP System for ER SS (Option-1 revised)

Region	Server Set		Phone (No.)		POE Switch (with dual DC)	Cat 6 cable (100m set)incl. installatio n	NGFW* (No.)	Grand Total (with AMC) of SS (in Crs.)
	Main*	Backup*	VOIP	Analog Phone (including gateway)				
SLDC,Ranchi	1	1	60	100	60	60	2	0.59
OPTCL ,Bhubneshwar	1	1	108	85	92	92	2	0.85
SLDC Bihar Patna	1	1	182	212	182	182	2	1.61
SLDC WB Howrah	1	1	182	212	182	182	2	1.61
SLDC DVC backup Maithan	0	1	87	150	70	70	1	0.71
SLDC DVC Kolkata	1	0	81	150	54	54	1	0.60
SLDC Sikkim	1	1	182	84	182	182	2	1.56

\* This BoQ pertains to Central Sector(CS) and has not been included in the cost.

**Grand Total**

**₹ 7.53**

# Tentative Cost & BoQ of Proposed VOIP System for NER SS (Option-1 revised)

Region	Server Set		Phone (No.)		POE Switch (with dual DC)	Cat 6 cable (100m set)incl. installation	NGFW* (No.)	Grand Total (with AMC) of SS (in Crs.)
	Main*	Backup*	VOIP	Analog Phone (including gateway)				
SLDC Imphal	1	1	70	24	40	40	2	0.47
SLDC,Meghalay (Nehu)	1	1	108	63	92	92	2	1.03
SLDC Guwahati- kahilipara	1	1	265	10	180	180	2	1.68
SLDC Mizoram(Aizwal)	1	1	68	23	38	38	2	0.45
SLDC (Nagaland)Diamapur	1	1	74	26	44	44	2	0.50
SLDC Agartala	1	1	90	34	60	60	2	0.65
SLDC Itanagar	1	1	114	46	84	84	2	0.76

\* This BoQ pertains to Central Sector(CS) and has not been included in the cost.

**Grand Total**

**₹ 5.54**

# Tentative Cost & BoQ of Proposed VOIP System for All regions CS +SS(Option-1 revised)

Region	CS(ISTS) (in Crs.)	SS(in Crs.)	Total(in Crs.)
NR	₹18.18	₹16.14	₹ 34.3227
SR	₹19.95	₹ 12.86	₹ 32.8099
WR	₹14.20	₹ 11.92	₹ 26.1236
ER	₹10.36	₹ 7.53	₹ 17.8878
NER	₹16.53	₹5.54	₹ 22.0682
NLDC	₹ 2.64	₹ 0	₹ 2.6325
Intl.	₹ 1.20	₹ 0	1.209754
Cyber Audit	₹ 2.8	₹ 0	₹ 2.8
	₹ 85.86	₹ 53.99	₹ 139.85



**Annexure-III**

GS. No.	Items	Details
1.	Name of Scheme	VOIP Communication system for Grid-Operation for all Five Regions NR, NER, SR, WR, ER as PAN India
2.	Scope of the scheme	Supply and installation of VOIP Communication system including Phones, Voice Recorder etc. for Grid-Operation for all Five Regions NR, NER, SR, WR, ER as PAN India at NLDC, RLDCs, SLDCs
3.	Objective / Justification	<ol style="list-style-type: none"> <li>1. Hot Line Speech Communication System (VOIP based PABX system) was implemented in 2016 by POWERGRID in all five regions after grid disturbance in 2012 where grid operators faced problem of fast communication due to unavailability of dedicated speech communication <b>PAN India</b> between NLDC, RLDCs, SLDCs, important state and ISTS substations and generators. The said PABX was implemented by M/s Orange through Alcatel Lucent as OEM. The lead region for the existing VoIP system is Northern Region of POWERGRID.</li> <li>2. In the 67th NRPC meeting, POWERGRID representative stated that the scheme executed by M/s ORANGE was with a provision of AMC of 7 years as part of the contract and the same is expiring in July' 2023 for most of the sites.</li> <li>3. AMC of the same was extended and approved in the 67th NRPC for further 2 years upto July'25 with financial implication and shall be booked under ULDC O&amp;M charges as per the CERC norms. After July'25 there is no support shall be extended by Alcatel (OEM). POWERGRID stated they are not able to maintain the system beyond that AMC expiration. MS-NRPC advised CTU to plan upgradation/ new system in view of expiration of AMC in July'25.</li> </ol>

GS. No.	Items	Details
		<p>4. Grid-India in 23<sup>rd</sup> NRPC- TeST meeting stated that as VOIP system is utmost requirement of Grid-Operation and shall be planned by CTU parallel as POWERGRID has to file petition in the CERC for revised depreciation of existing VOIP System in view of 15 years of useful life.</p> <p>5. In this regards CTU discussed the requirements with utilities &amp; various VOIP system suppliers/OEMs and proposed the VOIP System Architecture which is attached at <b>Annexure-III A</b>.</p> <p>6. Comparison between present and proposed VOIP System is attached at <b>Annexure-III B</b>.</p> <p>7. Broad Specifications of the proposed VOIP system is attached at <b>Annexure-III C</b></p> <p>8. In this regard inputs are acquired from the utilities in the various meetings of CPM, COM/ TeST/SCADA of all five regions. For the utilities those have provided inputs we have considered the same in the cost estimate purpose. Further a combined CPM(Communication planning meeting) of all five region was also held on 12.06.2024 to obtain uniformity of features and functions of the VoIP system among all regions. After incorporating the comments of all utilities MoM was issued.</p> <p>9. The project is of utmost importance for grid management and operation by grid operators and also time critical. As the AMC of existing system is expiring by July,2025 the proposed system needs to be placed before that.</p>

GS. No.	Items	Details
		<p>10. It is proposed that being a Nation wide project, the total cost of five regions including NLDC and international Exchange (Cross border links) VoIP system shall be put up in all five regions for RPC/s review followed by NCT approval as single Scheme and package PAN India Basis for seamless integration and installation purpose.</p> <p>11. Tentative cost of the scheme is <b>Rs. 137.46 Crs.</b> (including 6 years AMC after completion of 1 year warranty period) Excluding taxes &amp; Duties</p> <p>12. There are three types of cost involved, Regional Central Sector, National Central Sector, State Sector. The sharing of cost shall be done as per following mechanism between constituents:</p> <ul style="list-style-type: none"> <li>(i) Regional Central Sector Cost to be shared by respective region DICs as per CERC (Sharing of Inter-State Transmission Charges and Losses) Regulations, 2020 under Regional Component.</li> <li>(ii) National Central Sector Cost to be shared by all regional DICs as per CERC (Sharing of Inter-State Transmission Charges and Losses) Regulations, 2020 under National Component.</li> <li>(iii) State Sector Cost shall be shared by respective state/s for their portion as per CERC (Sharing of Inter-State Transmission Charges and Losses) Regulations, 2020.</li> <li>(iv) AMC for State Sector shall be shared by respective states for their portion as per CERC (Sharing of Inter-State Transmission Charges and Losses) Regulations, 2020.</li> </ul>

GS. No.	Items	Details
4.	Estimated Cost	<p>Total project cost : 137.46 Crs. (including 6 years AMC after completion of 1 year warranty period) (Excluding taxes &amp; Duties)</p> <p>NR – Rs. 34.46 Crs      ER – Rs. 19.76 Crs.</p> <p>SR – Rs. 27.98 Crs.      NER- Rs. 22.36 Crs.</p> <p>WR – Rs. 26.35 Crs.      National – Rs. 6.55 Crs.</p> <p>Breakup of estimated cost and tentative BoQ at Regional, National and State Sector wise is attached at <b>Annexure-IIID</b>. After approval of the scheme POWERGRID shall prepare detailed BoQ as per actual requirement.</p>
5.	Implementation timeframe	9 months from the date of allocation
6.	Implementing Agency / Mode	<b>POWERGRID/ RTM</b>
7.	Deliberations in different meetings	<ul style="list-style-type: none"> <li>i. 67<sup>th</sup> NRPC dtd. 30.06.2023</li> <li>ii. Joint CPM of all Region dtd. 12.06.24</li> <li>iii. 23<sup>rd</sup> NRPC TeST dtd. 21.09.2023</li> <li>iv. 24<sup>th</sup> NRPC TeST dtd. 09.02.2024</li> <li>v. NR CPM 5<sup>th</sup> ,6<sup>th</sup> dated 20-03-2024 &amp; 23.04.2024 respectively.</li> <li>vi. 44<sup>th</sup> COM SR dtd.21.03.2024</li> <li>vii. 46<sup>th</sup> COM SR dtd.22.05.2024</li> <li>viii. SR CPM 4<sup>th</sup> ,5<sup>th</sup> dated 31.07.2023 &amp; 18.04.2024 respectively</li> <li>ix. WR 4<sup>th</sup> ,5<sup>th</sup> CPM dated 26-07-2023 &amp; 28-03-2024 respectively.</li> <li>x. 28th NETeST meeting dtd. 14.05.2024</li> <li>xi. 4<sup>th</sup> CPM of NER region dtd. 28.07.2023</li> <li>xii. 14<sup>th</sup> ER TeST dtd. 16.04.24</li> <li>xiii. ER 4<sup>th</sup> CPM dtd. 27.07.2023</li> </ul>



# Proposed VOIP System Architecture:

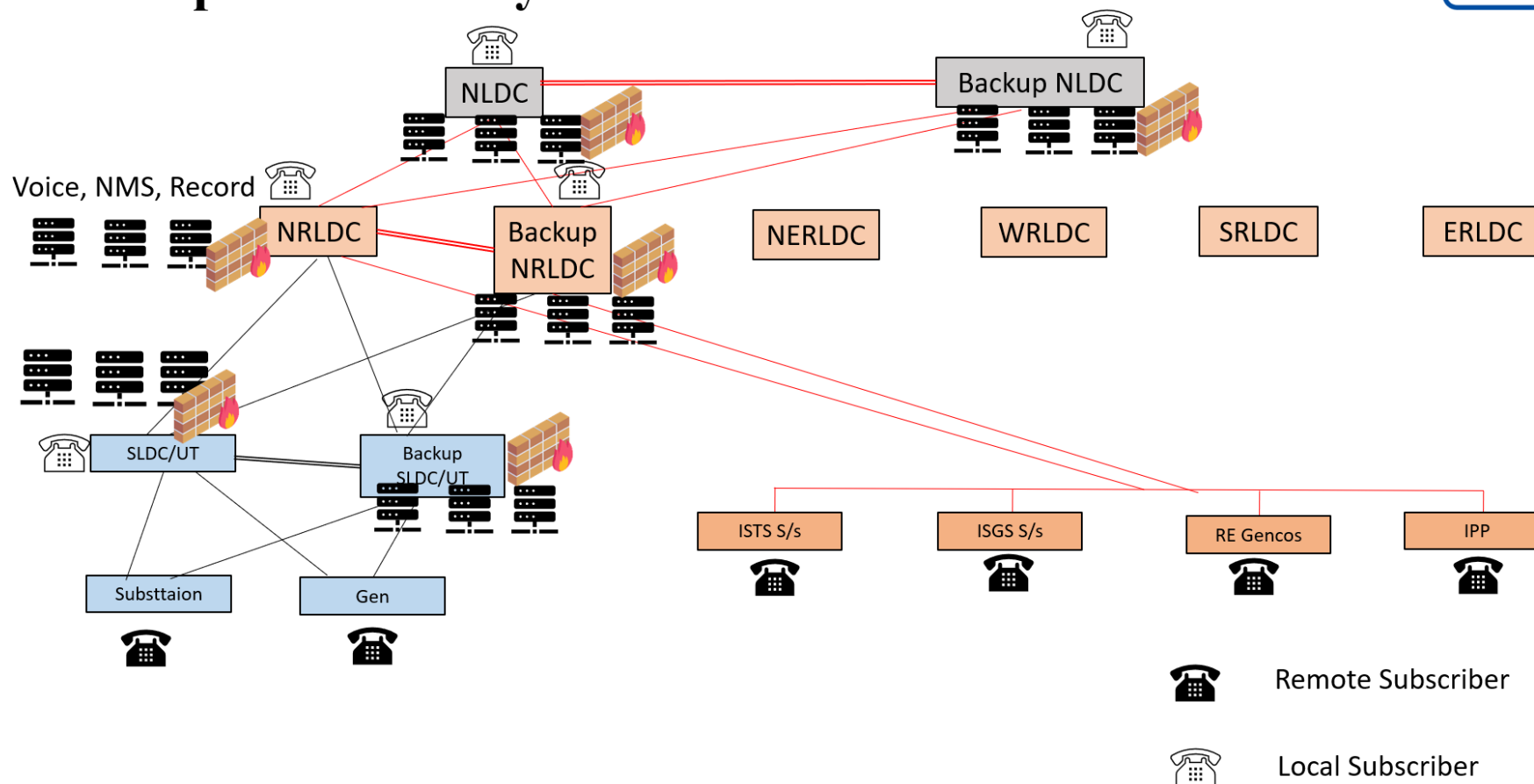

**Comparison of features between present and proposed VOIP System**

S. No	Present VOIP Exchange	Proposed VOIP system
1	Exchange based system	Server based system
2	Star based architecture and no redundancy between exchanges (SLDC/RLDC/NLDC)	Multiple level of Redundancy kept.  At phone level two channels are proposed for main and backup exchanges of SLDCs and RLDCs.  For State sector four level Hardware redundancy has been considered as e.g. Main SLDC/ Back Up SLDC/ Main RLDC/ Backup RLDC  For Central sector four level Hardware redundancy has been considered as e.g. Main RLDC/ Back Up RLDC/ Main NLDC/ Backup NLDC
3	Proprietary License based system	SIP based open source licenses
4	The IP Phones connected at NLDC, RLDC and	IP Phones shall not be proprietary in nature.

	SLDC are proprietary IP Phones of Alcatel	
5	No PoE Switches	POE switch with dual redundancy considered
6	NA	Firewall are considered for cyber security
7	NA	Cyber Security Audit is considered
8	NA	Provision of video phones at Control Centre for higher officials
9	NA	Sufficient numbers of licenses considered to cater future RE/ ISTS/ ISGS/ IPP and STU substations locations.
10	Recording done at one location	Recording at each Control Centre shall be done locally and later at regular intervals transferred to a backup server for storage and archival

Broad Specifications of proposed VOIP System

1. Server based architecture: Multiple level (4 level) of redundancy as compared to no redundancy in existing system.
2. SLDC & RLDC servers has Local (Control Centre phones) and Remote (Substation, Generators) Phone support. However, at NLDC only local phone support has been considered.
3. Power over ethernet (PoE) switches with dual DC supply ports has been considered for all VOIP phones at remote stations for redundancy and powering the phones.
4. One set of three servers are proposed for Voice (VOIP), NMS & Call Recording at each control centre.
5. There is no duplication of licenses for backup servers.
6. Server size and software has been considered by taking future requirement of phones.
7. Support for integration of future exchange of other utilities considered (their control centres).
8. NMS for adding/ deleting users shall be provided at RLDC/ SLDC levels
9. Operator console shall be provided to manage calls at RLDC/SLDC
10. Call recording features shall be provided at RLDC & SLDC level with backup.
11. VOIP, Analog & Four Wire E&M (at PLCC locations) phones are considered
12. Video Phones at RLDC/ SLDC for Senior officials
13. Sufficient numbers of licenses to cater future RE/ ISTS/ ISGS/ IPP and STU substations locations. The licenses for present and future requirement of the phones are considered under the scope of project, however phones for present requirement only shall be procured.
14. Firewall at control centres is considered
15. Installation with 100m Cat-6 cable considered at remote locations.
16. Integration with existing STU exchanges has been considered.
17. One Exchange for international communication for cross border links has been considered at NLDC main and Backup NLDC.
- 18. 6 year of AMC has been considered after 1 year warranty.**
19. Cyber Security Audit has been considered.



**Cost Breakup Between Regions and Central Sector and State Sector**

<b>Region</b>	<b>Central Sector (ISTS) (in Crs.)</b>	<b>State Sector (in Crs.)</b>	<b>Total (including 6yr AMC after completion of 1 yr warranty period &amp; excluding taxes) (in Crs.)</b>
<b>NR</b>	<b>₹18.54</b>	<b>₹15.92</b>	<b>₹ 34.46</b>
<b>SR</b>	<b>₹15.3</b>	<b>₹ 12.68</b>	<b>₹ 27.98</b>
<b>WR</b>	<b>₹14.61</b>	<b>₹ 11.74</b>	<b>₹ 26.35</b>
<b>ER</b>	<b>₹12.32</b>	<b>₹ 7.44</b>	<b>₹ 19.76</b>
<b>NER</b>	<b>₹16.91</b>	<b>₹5.45</b>	<b>₹ 22.36</b>
<b>National Component (NLDC, International exchange and Cyber audit)</b>	<b>₹ 6.55</b>	<b>₹ 0</b>	<b>₹ 6.55</b>

**Grand Total ₹ 137.46 Crs. (including 6year of AMC after completion of 1 yr warranty period) (excluding GST/TAXES)**

## Northern Region Cost Breakup

Northern Region Utility	Servers		Phones			POE Switch (with dual DC) (No.)	Cat 6 cable (100m set) incl. installation (No.)	NGFW* (No.)	Total Cost with AMC (6 Yr after 1 Yr. warranty (in Crs.))	Total cost (in Crs.)	Central Sector (CS)/State Sector (SS)
	Main (No.)	Backup (No.)	VOIP (Local) (No.)	VOIP (Remote) (No.)	Analog Phone (including gateway) (No.)						
NRLDC	1	1	28	450	350	450	450	2	18.44	18.44	CS*
SLDC DTL	1*	1*	33	193	0	193	193	2*	1.59	16.02	SS
SLDC, RRVPNL	1*	1*	24	0	49	24	25	2*	0.180		
SLDC, BBMB	1*	1*	30	152	116	152	152	2*	1.55		
SLDC, PSTCL, Patiala	1*	1*	6	197	8	197	197	2*	1.62		
SLDC, HPSEBL	1*	1*	30	152	164	152	152	2*	1.57		
SLDC, UPPTCL	1*	1*	20	800	0	800	800	2*	6.40		
SLDC, HVPNL	1*	1*	0	0	0	0	0	2*	0		
SLDC, JKPTCL	1*	1*	30	152	148	152	152	2*	1.56		
SLDC, PTCUL	1*	1*	30	152	116	152	152	2*	1.55		

\*Servers and NGFW shall be physically placed at SLDCs for STUs but their cost has been included in Central Sector Portion

Grand Total ₹34.46 Crs. (including AMC) (excluding GST/TAXES)

### Cost breakup of Southern Region

Southern Region Utility	Servers		Phones			POE Switch (with dual DC) (No.)	Cat 6 cable (100m set) incl. installation (No.)	NGFW* (No.)	Total Cost with AMC (6 Yr after 1 Yr. warranty) (in Crs.)	Total cost (in Crs.)	Central Sector (CS)/State Sector (SS)
	Main (No.)	Backup (No.)	VOIP (Local) (No.)	VOIP (Remote) (No.)	Analog Phone (including gateway) (No.)						
SRLDC	1	1	232	400	150	400	400	2	15.30	15.30	CS*
KSEB	1*	1*	17	546	0	546	546	2*	4.43	12.68	SS
TSTRANCO	1*	1*	62	800	20	800	800	2*	6.64		
KPTCL	1*	1*	2	0	0	0	0	2*	0.0015		
Puducheery	1*	1*	34	41	64	41	41	2*	0.49		
TANTRANSCO	1*	1*	11	130	18	130	130	2*	1.12		
APTRANSCO	1*	1*	0	0	0	0	0	2*	0.00		

\*Servers and NGFW shall be physically placed at SLDCs but cost has been included in Central Sector Portion

**Grand Total                    ₹27.98 Crs. (including AMC) (excluding GST/TAXES)**

### Cost breakup of Western Region

Western Region Utility	Servers		Phones			POE Switch (with dual DC) (No.)	Cat 6 cable (100m set) incl. installation (No.)	NGFW* (No.)	Total Cost with AMC (6 Yr after 1 Yr. warranty (in Crs.)	Total cost (in Crs.)	Central Sector (CS)/State Sector (SS)
	Main (No.)	Backup (No.)	VOIP (Local) (No.)	VOIP (Remote) (No.)	Analog Phone (including gateway) (No.)						
WRLDC	1	1	100	500	20	500	500	2	14.61	14.61	CS*
SLDC, Panjim	1*	1*	10	48	84	48	48	2*	0.87	11.74	SS
SLDC, Bhopal	1*	1*	30	400	220	400	400	2*	3.35		
SLDC, Raipur	1*	1*	30	400	148	400	400	2*	3.30		
SLDC, Vadodara	1*	1*	30	150	244	150	150	2*	1.75		
SLDC, Mumbai	1*	1*	30	200	244	200	200	2*	1.60		
SLDC Daman & Diu	1*	0	10	40	84	40	40	1*	0.48		
SLDC DNH	1*	0	10	40	0	40	40	1*	0.39		

\*Servers and NGFW shall be physically placed at SLDCs but their cost has been included in Central Sector Portion

**Grand Total ₹26.35 Crs. (including AMC) (excluding GST/TAXES)**

## Cost breakup of Eastern Region

Eastern Region Utility	Servers		Phones			POE Switch (with dual DC) (No.)	Cat 6 cable (100m set)incl. installation (No.)	NGFW* (No.)	Total Cost with AMC (6 Yr after 1 Yr. warranty (in Crs.)	Total cost (in Crs.)	Central Sector (CS)/State Sector (SS)
	Main (No.)	Backup (No.)	VOIP (Local) (No.)	VOIP (Remote) (No.)	Analog Phone (including gateway) (No.)						
ERLDC	1	1	150	200	100	200	200	2	12.32	<b>12.32</b>	<b>CS*</b>
SLDC, Ranchi	1*	1*	10	50	100	60	60	2*	0.58	<b>7.44</b>	<b>SS</b>
OPTCL	1*	1*	16	92	85	92	92	2*	0.84		
SLDC Bihar Patna	1*	1*	30	152	212	152	152	2*	1.59		
SLDC WB Howrah	1*	1*	30	152	212	152	152	2*	1.59		
SLDC DVC backup Maithan	0	1*	17	70	150	70	70	1*	0.70		
SLDC DVC Kolkata	1*	0	27	54	150	54	54	1*	0.60		
SLDC Sikkim	1*	1*	30	152	84	152	152	2*	1.54		

\*Servers and NGFW shall be physically placed at SLDCs but their cost has been included in Central Sector Portion  
**Grand Total ₹19.76 Crs. (including AMC) (excluding GST/TAXES)**

## Cost breakup of North Eastern Region

Northern Eastern Region Utility	Servers		Phones			POE Switch (with dual DC) (No.)	Cat 6 cable (100m set) incl. installation (No.)	NGFW* (No.)	Total Cost with AMC (6 Yr after 1 Yr. warranty (in Crs.))	Total cost (in Crs.)	Central Sector (CS)/State Sector (SS)
	Main (No.)	Backup (No.)	VOIP (Local) (No.)	VOIP (Remote) (No.)	Analog Phone (including gateway) (No.)						
NERLDC	1	1	210	600	100	600	600	2	16.91	16.91	CS*
SLDC Imphal	1*	1*	30	40	24	40	40	2*	0.46	5.45	SS
SLDC, Meghalaya	1*	1*	16	92	63	92	92	2*	1.01		
SLDC Guwahati	1*	1*	85	180	10	180	180	2*	1.66		
SLDC Mizoram	1*	1*	30	38	23	38	38	2*	0.44		
SLDC (Nagaland)	1*	1*	30	44	26	44	44	2*	0.49		
SLDC Agartala	1*	1*	30	60	34	60	60	2*	0.64		
SLDC Itanagar	1*	1*	30	84	46	84	84	2*	0.75		

\*Servers and NGFW shall be physically placed at SLDCs but cost has been included in Central Sector Portion

**Grand Total                      ₹22.36 (including AMC) (excluding GST/TAXES)**

### National Component of VOIP System

Utility	Servers		Phones			POE Switch (with dual DC) (No.)	Cat 6 cable (100m set)incl. installation (No.)	NGFW (No.)	Total Cost with AMC (6 Yr after 1 Yr. warranty (in Crs.)	Central Sector (CS)/State Sector (SS)
	Main (No.)	Backup (No.)	VOIP (Local) (No.)	VOIP (Remote) (No.)	Analog Phone (including gateway) (No.)					
NLDC	1	1	42	0	400	0	0	2	2.60	<b>CS</b>
International Exchange	1	1	30	0	0	0	0	2	1.19	
Cyber Audit Cost									2.76	
<b>Grand Total ₹6.55 (including AMC) (excluding GST/TAXES)</b>										

**Procedure for Approval of Protection Settings in Northern Region**  
**(Finalized in 50<sup>th</sup> PSC meeting held on 29.04.2024)**

1. ISTS users shall submit proposal for new/revised protection settings to NRLDC and similarly non-ISTS users shall submit to concerned SLDCs in the prescribed formats (of NRLDC/SLDC) in 2 weeks advance.
2. Further, NRLDC/SLDC (as the case may be) will scrutinize the proposal and any deficiency/additional data may be asked by NRLDC/NLDC. If required, NRLDC/SLDC may convene a meeting/interaction with stakeholders.
3. After scrutiny, NRLDC/SLDC will convey to user within 10 days (after receiving proposal) the accepted settings for implementation at site.
4. After implementation of approved settings, stakeholder will intimate to NRPC Secretariat via e-mail at [seo-nrpc@nic.in](mailto:seo-nrpc@nic.in) within a fortnight.
5. NRLDC/SLDCs shall place all accepted settings as agenda in upcoming PSC meeting for final approval of forum.

\*\*\*\*\*



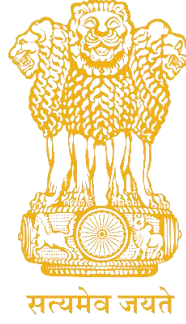

**उत्तर क्षेत्रीय विद्युत समिति**  
**NORTHERN REGIONAL POWER COMMITTEE**

**Procedure for Approval of Protection  
Settings in Northern Region**

**Version: 1.0**

*(Approved in 51st PSC meeting held on 23.07.2024)*

**August, 2024**

## **Procedure for Approval of Protection Settings in Northern Region**

### **A. Delegated Authority:**

NRLDC/SLDCs may accept protection settings and allow charging, if settings are as per protection philosophy of NRPC. However, approval of PSC forum shall be taken when protection settings require deviation from NRPC philosophy.

### **B. Procedure in case of new element charging**

1. ISTS users shall submit the protection settings to NRPC and NRLDC for every new element to be commissioned one month in advance through mail.  
In case of intrastate elements, users shall submit the protection settings to concerned SLDC and NRPC for every new element to be commissioned one month in advance through mail.
2. NRLDC shall allow integration of new element in the system based on the protection settings submitted by ISTS user during First Time Charging (FTC) request through Outage Management System (OMS) portal of NRLDC, after scrutiny of settings for compliance of NRPC protection philosophy.  
In case of intrastate elements, SLDC shall scrutinize the settings for compliance of NRPC protection philosophy and allow integration of new element in the system.
3. NRLDC/SLDCs may ask any other relevant data/information from concerned utilities during scrutiny of settings.
4. While accepting protection settings and allowing charging clearance, NRLDC/SLDCs shall convey other concerned utility of existing element, for revision of settings at their end, if required due to charging of new element.
5. If settings are not in line with NRPC protection philosophy, NRLDC/SLDC may reject the settings and the concerned utility (both ISTS and intrastate) shall put up an agenda for getting approval of settings in next PSC.
6. Utility shall intimate to NRPC Secretariat and NRLDC/SLDC (as applicable) within fortnight after implementation of settings for record in regional protection settings database.

### **C. Procedure in case of revision of settings of any existing element:**

1. Concerned utilities shall submit the proposal to NRLDC/SLDC (as applicable) for revision of protection settings arising due to any issue.

2. NRLDC/SLDC (as applicable) shall allow the revision if settings are as per NRPC protection philosophy. If settings are not in line with NRPC protection philosophy, NRLDC/SLDC may reject the settings and the concerned utility (both ISTS and intrastate) shall put up an agenda for getting approval of settings in next PSC.
3. Utility shall intimate to NRLDC/SLDC (as applicable) and NRPC Secretariat within fortnight after implementation of settings for record in database.

\*\*\*\*\*



सत्यमेव जयते

# उत्तर क्षेत्रीय विद्युत समिति

NORTHERN REGIONAL POWER COMMITTEE

## **Procedure for Approval of Protection Settings in Northern Region**

**(In reference to regulation 14 of IEGC 2023)**

Version: 1.0

*(Approved in 75<sup>th</sup> NRPC meeting held on 28.08.2024)*

August, 2024

**A. Procedure in case of new element charging**

1. ISTS users shall submit the protection settings to NRPC and NRLDC for every new element to be commissioned one month in advance through mail.  
In case of intrastate elements, users shall submit the protection settings to NRPC and concerned SLDC for every new element to be commissioned one month in advance through mail.
2. NRLDC based on the above information and the First Time Charging (FTC) request by user through Outage Management System (OMS) portal of NRLDC, shall allow integration of new element in the system as per NRLDC FTC procedure with the prevailing practice to avoid any delay in charging of the new element. The settings shall be treated as provisional arrangement till approval in PSC (Protection Sub-Committee).  
In case of intrastate elements, SLDC shall allow integration of new element in the system. This shall be treated as provisional arrangement till approval in PSC.
3. NRLDC/SLDCs may ask any other relevant data/information from concerned utilities during scrutiny of settings.
4. Users will be responsible for any revision in settings of the existing element required due to charging of new element. The settings shall be treated as provisional arrangement.
5. The concerned utility shall put up the agenda for getting final approval in next PSC.
6. NR PSC will review and approve the final settings based on the inputs submitted by the utility. In case of any change required in final protection settings of the new element than the provisional one, as decided by the committee, the same shall be implemented within 7 days by the concerned utility.
7. Utility shall intimate to NRPC Secretariat and NRLDC/SLDC (as applicable) within fortnight after implementation of settings for record in regional protection settings database.

**B. Procedure in case of revision of settings of any existing element (without any changes in network configuration):**

1. Any change in the existing protection settings shall be carried out only after prior approval from PSC Forum of NRPC.
2. The concerned utility (both ISTS and intrastate) shall put up an agenda regarding any changes required in existing protection settings due to integration of new element in the existing system or otherwise, in PSC.
3. Utility shall intimate to NRLDC/SLDC (as applicable) and NRPC about the changes implemented in protection system or protection settings within 15 days of such changes.

\*\*\*\*\*



भारत सरकार  
Government of India  
विद्युत मंत्रालय  
Ministry of Power  
उत्तर क्षेत्रीय विद्युत समिति  
Northern Regional Power Committee

**विषय: Minutes of the meeting to discuss HVPN proposal to connect 220kV BBMB Samaypur Ckt-1 to 220kV FGPP Ckt-1 directly instead of existing LILO arrangement-reg.**

Kindly find attached minutes of the meeting held on **03.06.2024 (11:00 AM)** to discuss the HVPN proposal to connect 220kV BBMB Samaypur Ckt-1 to 220kV FGPP Ckt-1 directly instead of existing LILO arrangement.

Encl: As above

Signed by Dharmendra  
Kumar Meena  
Date: 07-06-2024 12:56:46

(डी. के. मीना)  
अधीक्षण अभियंता (प्रचालन)

To,

1. Chief Engineer, PSPA-I, CEA ([cea-pspa1@gov.in](mailto:cea-pspa1@gov.in))
2. CGM(SO), NRLDC ([somara.lakra@grid-india.in](mailto:somara.lakra@grid-india.in))
3. GM, CTU ([kashish@powergrid.in](mailto:kashish@powergrid.in))
4. CGM, Powergrid NR-1 ([ravindrangupta@powergrid.in](mailto:ravindrangupta@powergrid.in))
5. Dy. General Manager, NTPC NRHQ ([hrastogi@ntpc.co.in](mailto:hrastogi@ntpc.co.in))
6. Dy. Chief Engineer BBMB ([dirpr@bbmb.nic.in](mailto:dirpr@bbmb.nic.in))
7. Chief Engineer (SO) Haryana SLDC ([cesocomml@hvpn.org.in](mailto:cesocomml@hvpn.org.in))
8. Chief Engineer (SO), HVPN ([cetspkl@hvpn.org.in](mailto:cetspkl@hvpn.org.in))

**Minutes of the meeting held on 03.06.2024 (11:00 HRS) to discuss HVPN proposal to connect 220kV BBMB Samaypur Ckt-1 to 220kV FGPP Ckt-1 directly instead of existing LILO arrangement**

1. Member Secretary NRPC welcomed all participants and informed that HVPN has submitted a proposal to connect 220kV BBMB Samaypur Ckt-1 to 220kV FGPP Ckt-1 directly instead of existing LILO arrangement
2. HVPN representative informed that a 220kV GIS S/stn. at sector-58, Faridabad (Haryana) with its feeding through LILO of both Ckts of 220kV D/C line from 400kV PGCIL Samaypur to FGPP Ballabgarh (line being maintained by PGCIL), was commissioned on 18.09.2021 and is in service since then. On 20.01.2024, 220kV indoor termination kit of R-phase of 220kV Sector-58 - FGPP Ckt-1 got damaged along with consequential loss in the associated GIS module which further resulted into tripping of the said circuit.
3. He also informed participants that the tentative time for restoration for R-phase termination kit and GIS module at 220kV GIS S/Stn. Sector-58, Faridabad is tentatively 08 to 10 months as per the communication received from OEM (M/s Siemens).
4. Further he stated that since the generation at FGPP has now started, so it will be appropriate that 220kV BBMB Samaypur Ckt-1 to 220kV FGPP Ckt-1 is connected directly by making flying jumpers as per site feasibility in order to ensure safe and reliable grid operation besides mitigating the issue of N-1 contingency for proper evacuation of power from both the sources i.e. FGPP end and Samaypur end as a stop-gap arrangement till the restoration work at 220V GIS S/stn. sector-58, Faridabad is completed by the OEM. This shall also result in restoration of complete 220kV level ring main system in Faridabad district which shall aid in coping up the load demand in the ongoing summer season which is likely to peak out in the coming months.
5. HVPN representative presented the existing as well as proposed arrangement. He mentioned that the load flow study case has been carried out considering the approved transmission network of Haryana in synchronization mode considering full generation of Faridabad Gas Plant along with Maximum demand observed till date on 400/220/66 kV level transformers in PSSe software. While carrying out load flow study, none of the transmission elements are found overloaded in Base Case (i.e. LILO of one ckt. of 220kV Samaypur-FGTPP D/C line at 220kV S/stn., Sec-58 Faridabad and its contingencies.
6. NRLDC representative pointed out that the maximum load at 220kV ICTs at Faridabad Sec-58 is around 200 MW. In the event when Faridabad gas is not running, the proposal of Haryana to connect 220kV BBMB Samaypur Ckt-1 to 220kV FGPP Ckt-1 directly instead of existing LILO arrangement of 220kV BBMB Samaypur-FGPP Ckt-1 at 220kV S/stn, Sector-58, Faridabad, will overload the remaining 220kv Samaypur-Faridabad Sec-58 line to 218 MW beyond its thermal rating. Sensitivity at the remaining 220kv Samaypur-Faridabad Sec-58 line is observed to be 66% in event of directly connecting

- 220kV BBMB Samaypur Ckt-1 to 220kV FGPP Ckt-1 instead of existing LILO arrangement.
7. HVPN representative mentioned that in their PSSe study for the event when Faridabad gas is not running, the loading at remaining 220kv Samaypur-Faridabad Sec-58 line would be around 235 MW.
  8. SE(TS) Faridabad, mentioned that there is no possibility to shift load at 220kV Faridabad Sec-58 S/s only load regulation is the option.
  9. MS, NRPC asked HVPN and Powergrid NR-1 to jointly conduct the survey of the site to access feasibility of making flying jumpers and thereafter may mutually decide the mode of implementation and terms of agreement, so that the proposal gets executed at the earliest.
  10. CGM(SO), NRLDC mentioned that in view of overloading at remaining 220kv Samaypur-Faridabad Sec-58 line in event of directly connecting 220kV BBMB Samaypur Ckt-1 to 220kV FGPP Ckt-1 instead of existing LILO arrangement, HVPN has stated that there would be doing load management accordingly.
  11. SE(TS) Faridabad, mentioned that upon restoration of R-phase terminal kit and GIS module at 220kV GIS S/stn. sec-58, Faridabad the original arrangement would be restored.
  12. CTU representative stated that with the implementation of interim arrangement HVPN shall monitor the load at the remaining 220kv Samaypur-Faridabad Sec-58 line with overcurrent relay and do load management at 210MW to avoid any major contingency.
  13. MS NRPC asked HVPN to explore the possibility of SPS at 220kV GIS S/stn. sec-58, Faridabad.
  14. To this query, SE(Planning) HVPN replied that rather SPS they would prefer to do manual rostering on rotational basis. Further, he mentioned that they are coming up with the proposal for reconductoring both the circuits of 220kv Samaypur-Faridabad Sec-58 line to HTLS.
  15. BBMB and NTPC representative mentioned that HVPN shall inform them well in advance before carrying out the interim arrangement to review protection settings at their end.
  16. CGM(SO), NRLDC mentioned that FTC clearance would be required as the existing network is getting modified.

**Decision of Meeting: -**

1. HVPN and Powergrid NR-1 to jointly conduct the survey of the site to access feasibility of making flying jumpers and thereafter may mutually decide the mode of implementation and terms of agreement, so that the proposal gets executed at the earliest.
2. HVPN shall inform to BBMB and NTPC well in advance before carrying out the interim arrangement to review protection settings at their end.
3. FTC clearance would be required as the existing network is getting modified.



Meeting ended with vote of thanks to the Chair.

\*\*\*\*\*

S.No.	Entity Name	User Type	Registration No	Registration Date	Registered Installed Capacity (MW)	Ckt kM Length
1	Delhi Buyer(DMRC Ltd)	Buyer	NRRDMRBY	26-02-2021	0	0
2	Delhi International Airport Limited	Buyer	NRRDE1BU	31-07-2023	0	0
3	National Fertilizers Limited, Nangal Punjab	Buyer	NRRNFNBY	26-03-2018	0	0
4	Northern Central Railway	Buyer	NRRRL1BY	20-05-2011	0	0
5	INVVN (SNA NEA-UP)	Buyer	NRRNE1BU	29-04-2024	0	0
6	INVVNL (SNA Nepal)	Buyer	NRRNVNBY	30-03-2020	0	0
7	PG-HVDC-NR	Buyer	NRRPGHBY	30-11-2023	0	0
8	Delhi	Distribution Licensee	NRRDL1DS	02-07-2010	0	0
9	Haryana	Distribution Licensee	NRRHR1DS	21-09-2011	0	0
10	Himachal Pradesh	Distribution Licensee	NRRHP1DS	09-06-2011	0	0
11	Punjab	Distribution Licensee	NRRPU1DS	30-08-2010	0	0
12	Rajasthan	Distribution Licensee	NRRRJ1DS	10-08-2011	0	0
13	UT Chandigarh	Distribution Licensee	NRRCH1DS	10-08-2011	0	0
14	UT J&K	Distribution Licensee	NRRJK1DS	30-09-2011	0	0
15	Uttar Pradesh	Distribution Licensee	NRRUP1DS	15-07-2011	0	0
16	Uttarakhand	Distribution Licensee	NRRUA1DS	03-08-2011	0	0
17	ADHPL	Generating Station	NRRAD1SL	10-09-2010	192	0
18	Anta GPP	Generating Station	NRRAN1GN	09-06-2011	419	0
19	Auraiya GPP	Generating Station	NRRAU1GN	09-06-2011	663	0
20	Bairasiul HPS	Generating Station	NRRBS1GN	01-06-2011	180	0
21	Bhakra Complex	Generating Station	NRRBC1GN	05-02-2016	1568.73	0
22	Budhil, HPS	Generating Station	NRRBD1SL	22-05-2012	70	0
23	Chamera-I HPS	Generating Station	NRRCM1GN	04-06-2010	540	0
24	Chamera-II HPS	Generating Station	NRRCM2GN	09-06-2011	300	0
25	Chamera-III HPS	Generating Station	NRRCM3GN	26-03-2012	231	0
26	Dadri GPP	Generating Station	NRRDD1GN	05-05-2011	830	0
27	Dadri NCTPS	Generating Station	NRRDA1GN	07-04-2010	840	0
28	Dadri Stage-II NCTPS	Generating Station	NRRDA2GN	05-05-2011	980	0
29	Dehar HEP	Generating Station	NRRDE1GN	05-02-2016	990	0
30	Dhauliganga HPS	Generating Station	NRRDG1GN	29-06-2011	280	0
31	Dulhasti HPS	Generating Station	NRRDU1GN	09-05-2011	390	0
32	IGSTPS	Generating Station	NRRIG1GN	02-12-2010	1500	0
33	Khurja STPP	Generating Station	NRRKH1GN	06-09-2022	1320	0
34	Kishanganga HEP	Generating Station	NRRKG1GN	01-03-2018	330	0
35	Koteshwar HPS	Generating Station	NRRKT1GN	25-06-2011	400	0
36	KWHPS	Generating Station	NRRKW1GN	18-05-2011	1045	0
37	NAPS	Generating Station	NRRNA1GN	10-05-2011	440	0
38	Nathpa-Jhakri HPS	Generating Station	NRRNJ1GN	06-07-2010	1500	0
39	NTPC KOLDAM HYDRO ELECTRIC POWER PLANT	Generating Station	NRRKD1GN	08-04-2015	800	0
40	Parbati-II, HEP	Generating Station	NRRPB2GN	18-09-2018	800	0
41	Parbati-III, HEP	Generating Station	NRRPB3GN	22-08-2013	520	0
42	Pong HEP	Generating Station	NRRPO1GN	05-02-2016	396	0
43	Rampur HEP	Generating Station	NRRRS1GN	07-02-2014	412	0
44	RAPP-7&8, NPCIL	Generating Station	NRRRADGN	04-04-2019	1400	0
45	RAPS - B	Generating Station	NRRRABGN	09-05-2011	440	0
46	RAPS-C	Generating Station	NRRRACGN	27-05-2011	440	0
47	Rihand -I STPS	Generating Station	NRRRI1GN	27-11-2011	1000	0
48	Rihand -II STPS	Generating Station	NRRRI2GN	27-11-2011	1000	0
49	Rihand-III, STPS	Generating Station	NRRRI3GN	25-04-2012	1000	0
50	Sainj HEP	Generating Station	NRRSJ1GN	26-05-2017	100	0
51	Salal HPS	Generating Station	NRRSL1GN	20-05-2011	690	0
52	SCL Bewar	Generating Station	NRRBW1SL	12-04-2011	300	0
53	SEWA-II	Generating Station	NRRSW1GN	09-05-2011	120	0
54	Singoli-Bhatwari HEP	Generating Station	NRRSBHGN	19-10-2020	99	0
55	Singrauli Small Hydro Station	Generating Station	NRRSH1GN	29-08-2017	8	0
56	Singrauli STPS	Generating Station	NRRSI1GN	04-05-2011	2000	0
57	SORANG HEP	Generating Station	NRRSP1GN	23-09-2013	100	0
58	Tanakpur HPS	Generating Station	NRRTP1GN	01-06-2011	94	0
59	Tanda Stage II	Generating Station	NRRTN2GN	07-11-2019	1320	0
60	Tehri HPS	Generating Station	NRRTE1GN	20-04-2010	1000	0
61	Unchahar-I TPS	Generating Station	NRRUN1GN	10-05-2017	420	0
62	Unchahar-II TPS	Generating Station	NRRUN2GN	10-05-2017	420	0
63	Unchahar-III TPS	Generating Station	NRRUN3GN	10-05-2017	210	0
64	Unchahar-IV TPS	Generating Station	NRRUN4GN	22-12-2016	500	0
65	URI 2 HEP	Generating Station	NRRUR2GN	14-03-2013	240	0
66	Uri HPS	Generating Station	NRRUR1GN	18-05-2011	480	0
67	Adani Renewable Energy Park Rajasthan Limited Fatehgarh-I	Others (SPPD/ WPPD/ HPPD)	NRRAR1HPPD	15-11-2021	1406	0
68	Prerak Greentech Private Limited	Others (SPPD/ WPPD/ HPPD)	NRRRGSPPD	28-12-2023	400	0
69	Rajasthan Solar Park Development Company Limited	Others (SPPD/ WPPD/ HPPD)	NRRRS1SPPD	21-07-2023	190	0
70	ABC Renewable Energy (RJ-01) Private Limited	RE Generating Station (SPD/ WPD / HPD)	NRRABCGN	12-04-2022	300	0
71	ACME Chittorgarh Solar Energy Pvt Ltd	RE Generating Station (SPD/ WPD / HPD)	NRRAC1GN	03-10-2019	250	0
72	ACME Deoghar Solar Power Private Limited	RE Generating Station (SPD/ WPD / HPD)	NRRADSGN	03-04-2024	300	0
73	ACME Heergarh Powertech Private Limited	RE Generating Station (SPD/ WPD / HPD)	NRRAC2GN	24-03-2022	300	0
74	Adani Hybrid Energy Jaisalmer Four Limited Fatehgarh-I	RE Generating Station (SPD/ WPD / HPD)	NRRAH4GN	16-11-2021	1110.36	0
75	Adani Hybrid Energy Jaisalmer One Limited	RE Generating Station (SPD/ WPD / HPD)	NRRAH1GN	26-07-2021	461	0
76	Adani Hybrid Energy Jaisalmer Three Limited	RE Generating Station (SPD/ WPD / HPD)	NRRAH3GN	01-10-2021	375.8	0
77	Adani Hybrid Energy Jaisalmer Two Limited	RE Generating Station (SPD/ WPD / HPD)	NRRAH2GN	01-10-2021	375.8	0
78	Adani Renewable Energy (RJ) Limited Rawara	RE Generating Station (SPD/ WPD / HPD)	NRRAS1GN	13-04-2020	200	0

79	Adani Solar Energy Four Limited, Rawara	RE Generating Station (SPD/ WPD / HPD)	NRRKS1GN	13-04-2020	50	0
80	Adani Solar Energy Jaisalmer One Private Limited	RE Generating Station (SPD/ WPD / HPD)	NRRAJ1GN	13-10-2022	526.87	0
81	Adani Solar Energy Jaisalmer Two Private Limited	RE Generating Station (SPD/ WPD / HPD)	NRRSB3GN	11-08-2021	150	0
82	Adani Solar Energy Jaisalmer Two Private Limited (Project-2)	RE Generating Station (SPD/ WPD / HPD)	NRRSBP2GN	12-09-2023	150	0
83	Adani Solar Energy Jodhpur Five Private Limited Bhadla	RE Generating Station (SPD/ WPD / HPD)	NRRSB1GN	26-04-2019	200	0
84	Adani Solar Energy Jodhpur Two Limited, Rawara	RE Generating Station (SPD/ WPD / HPD)	NRRAG1GN	06-07-2020	50	0
85	Adani Solar Energy RJ One Private Limited Bhadla	RE Generating Station (SPD/ WPD / HPD)	NRRSB6GN	07-05-2021	300	0
86	ADANI SOLAR ENRGY RJ TWO PRIVATE LIMITED	RE Generating Station (SPD/ WPD / HPD)	NRRAS2GN	17-01-2024	180	0
87	ADEPT RENEWABLE TECHNOLOGIES PRIVATE LIMITED	RE Generating Station (SPD/ WPD / HPD)	NRRARTGN	01-01-2024	110	0
88	Altra Xergi Power Private Limited	RE Generating Station (SPD/ WPD / HPD)	NRRAXPGN	05-12-2023	380	0
89	AMP ENERGY GREEN FIVE PRIVATE LIMITED	RE Generating Station (SPD/ WPD / HPD)	NRRAM5GN	01-04-2024	100	0
90	AMP Energy Green Six Private Limited	RE Generating Station (SPD/ WPD / HPD)	NRRAMPGN	31-10-2023	100	0
91	AMPLUS AGES PRIVATE LIMITED	RE Generating Station (SPD/ WPD / HPD)	NRRRAAGN	30-10-2023	100	0
92	Auraiya Solar Power Plant NTPC Ltd.	RE Generating Station (SPD/ WPD / HPD)	NRRASUGN	28-09-2020	40	0
93	Avaada RJHN Private Limited Bikaner	RE Generating Station (SPD/ WPD / HPD)	NRRAV2GN	09-12-2021	240	0
94	Avaada Sunce Energy Private Limited Bikaner	RE Generating Station (SPD/ WPD / HPD)	NRRAV1GN	03-12-2021	350	0
95	Avaada Sunrays Energy Private Limited	RE Generating Station (SPD/ WPD / HPD)	NRRAV4GN	29-07-2022	320	0
96	Avaada Sustainable RJProject Private Limited Bikaner	RE Generating Station (SPD/ WPD / HPD)	NRRAV3GN	05-01-2022	300	0
97	Ayana Renewable Power One Private Limited, Bikaner	RE Generating Station (SPD/ WPD / HPD)	NRRAY1GN	30-12-2021	300	0
98	AYANA RENEWABLE POWER THREE PRIVATE LIMITED	RE Generating Station (SPD/ WPD / HPD)	NRRAY3GN	01-04-2024	300	0
99	Azure Power Forty One Private Limited Bhadla	RE Generating Station (SPD/ WPD / HPD)	NRRAZ4GN	07-07-2021	300	0
100	Azure Power Forty Three Private Limited	RE Generating Station (SPD/ WPD / HPD)	NRRAZ3GN	09-11-2020	600	0
101	AZURE POWER INDIA Pvt. Ltd., Bhadla (SPD)	RE Generating Station (SPD/ WPD / HPD)	NRRAB1GN	23-04-2019	200	0
102	Azure Power Maple Private Limited	RE Generating Station (SPD/ WPD / HPD)	NRRAZ5GN	27-09-2021	300	0
103	Azure Power Thirty Four Pvt. Ltd. Bhadla	RE Generating Station (SPD/ WPD / HPD)	NRRAZ2GN	29-08-2019	130	0
104	Banderwala Solar Plant TPPL	RE Generating Station (SPD/ WPD / HPD)	NRRTP2GN	01-02-2024	300	0
105	Clean Solar Power (Bhadla) Pvt. Ltd	RE Generating Station (SPD/ WPD / HPD)	NRRCB1GN	03-10-2019	300	0
106	Clean Solar Power (Jodhpur) Private Limited Bhadla	RE Generating Station (SPD/ WPD / HPD)	NRRCB2GN	09-02-2022	250	0
107	DADRI SOLAR PV POWER STATION	RE Generating Station (SPD/ WPD / HPD)	NRRDS1GN	06-02-2013	5	0
108	Devikot Solar Power Plant NGEL	RE Generating Station (SPD/ WPD / HPD)	NRRND1GN	10-11-2022	240	0
109	Eden Renewable Cite Private Limited	RE Generating Station (SPD/ WPD / HPD)	NRRD1GN	31-05-2021	300	0
110	Grian Energy Private Limited	RE Generating Station (SPD/ WPD / HPD)	NRRRGEGN	30-10-2023	100	0
111	Kolayat Solar Power Plant NGEL	RE Generating Station (SPD/ WPD / HPD)	NRRNK1GN	06-06-2022	550	0
112	Mega Solis Renewables Private Limited	RE Generating Station (SPD/ WPD / HPD)	NRRMRSGN	04-02-2021	250	0
113	Mega Suryaurja Private Limited	RE Generating Station (SPD/ WPD / HPD)	NRRMS1GN	09-05-2022	250	0
114	Nidan Solar Power Plant NGEL	RE Generating Station (SPD/ WPD / HPD)	NRRNSFGN	03-12-2021	296	0
115	Nokhra Solar Plant NGEL	RE Generating Station (SPD/ WPD / HPD)	NRRNN1GN	25-11-2022	300	0
116	NTPC ANTA SOLAR PV STATION	RE Generating Station (SPD/ WPD / HPD)	NRRASPGN	26-03-2024	90	0
117	Onevolt Energy Private Limited	RE Generating Station (SPD/ WPD / HPD)	NRRQEPGN	11-09-2023	100	0
118	Phalodi Solar Plant ASERJ2PL	RE Generating Station (SPD/ WPD / HPD)	NRRAS3GN	27-03-2024	150	0
119	ReNew Solar Energy Jharkhand Three Pvt. Ltd.	RE Generating Station (SPD/ WPD / HPD)	NRRRF2GN	11-08-2021	300	0
120	Renew Solar Power Pvt Ltd, Bikaner (250MW)	RE Generating Station (SPD/ WPD / HPD)	NRRRB2GN	22-10-2019	250	0
121	RENEW SOLAR POWER Pvt. Ltd. Bhadla, (SPD)	RE Generating Station (SPD/ WPD / HPD)	NRRRB1GN	22-04-2019	50	0
122	ReNew Solar Urja Pvt Ltd	RE Generating Station (SPD/ WPD / HPD)	NRRRF4GN	22-11-2021	300	0
123	Renew Sun Bright Private Limited	RE Generating Station (SPD/ WPD / HPD)	NRRRF3GN	14-10-2021	300	0
124	ReNew Sun Waves Private Limited, Fatehgarh-II	RE Generating Station (SPD/ WPD / HPD)	NRRRF1GN	23-07-2021	300	0
125	Renew Surya Aayan Private Limited	RE Generating Station (SPD/ WPD / HPD)	NRRRSAGN	27-12-2023	300	0
126	Renew Surya Pratap Private Limited	RE Generating Station (SPD/ WPD / HPD)	NRRRSPGN	08-12-2023	200	0
127	Renew Surya Ravi Private Limited Bikaner	RE Generating Station (SPD/ WPD / HPD)	NRRRB3GN	12-01-2022	300	0
128	Renew Surya Roshni Private Limited	RE Generating Station (SPD/ WPD / HPD)	NRRRSRGN	25-01-2024	423	0
129	Renew Surya Vihaan Private Limited	RE Generating Station (SPD/ WPD / HPD)	NRRRSVGN	12-12-2023	100	0
130	Rising Sun Energy (K) Private Limited	RE Generating Station (SPD/ WPD / HPD)	NRRRSEGN	21-07-2023	190	0
131	Serentica Renewables India 4 Private Limited	RE Generating Station (SPD/ WPD / HPD)	NRRSR4GN	07-03-2024	180	0
132	SERENTICA RENEWABLES INDIA 5 PVT LTD	RE Generating Station (SPD/ WPD / HPD)	NRRSR5GN	27-03-2024	220	0
133	SINGRAULI SOLAR PV POWER STATION	RE Generating Station (SPD/ WPD / HPD)	NRRS1GN	26-12-2014	15	0
134	Tata Power Green Energy Limited	RE Generating Station (SPD/ WPD / HPD)	NRRTPGGN	04-07-2022	225	0
135	Thar Surya 1 Private Limited	RE Generating Station (SPD/ WPD / HPD)	NRRTS1GN	14-01-2022	300	0
136	TP Saurya Limited	RE Generating Station (SPD/ WPD / HPD)	NRRTPSGN	18-05-2023	110	0
137	TPREL (Chhayan)	RE Generating Station (SPD/ WPD / HPD)	NRRTC1GN	21-08-2019	300	0
138	TRANSITION CLEANTECH SERVICES PRIVATE LIMITED	RE Generating Station (SPD/ WPD / HPD)	NRRTC5GN	30-01-2024	24.4	0
139	TRANSITION ENERGY SERVICES PRIVATE LIMITED	RE Generating Station (SPD/ WPD / HPD)	NRRTESGN	08-01-2024	84.4	0
140	TRANSITION GREEN ENERGY PRIVATE LIMITED	RE Generating Station (SPD/ WPD / HPD)	NRRTEGEGN	19-03-2024	100	0
141	TRANSITION SUSTAINABLE ENERGY SERVICES PRIVATE LIMITED	RE Generating Station (SPD/ WPD / HPD)	NRRTESEGN	19-03-2024	50	0
142	Unchahar Solar PV Plant	RE Generating Station (SPD/ WPD / HPD)	NRRUS1GN	27-03-2014	10	0
143	Delhi Seller (PPCL, Bawana)	Seller	NRRPPDSL	01-03-2021	274	0
144	Haryana Seller	Seller	NRRHR1SL	21-09-2011	124	0
145	HP Seller	Seller	NRRHP1SL	09-06-2011	217.1	0
146	Rajasthan Seller	Seller	NRRRJ1SL	10-08-2011	58	0
147	UP Seller (MUNPL)	Seller	NRRMU1SL	26-02-2021	0	0
148	AD Hydro Power Limited (ADHPL)	Transmission Licensee	NRRAD1TL	08-05-2023	0	353.3
149	Adani Transmission India Ltd.	Transmission Licensee	NRRAP1TL	23-09-2013	0	2528
150	Aravali Power Company Private Limited	Transmission Licensee	NRRAR1TL	02-04-2014	0	131.38
151	BIKANER-KHETRI TRANSMISSION LIMITED	Transmission Licensee	NRRBK1TL	23-04-2021	0	481.3
152	Fatehgarh Bhadla Transmission Limited	Transmission Licensee	NRRFB1TL	16-12-2020	0	291.94
153	Gurgoan Palwal Transmission Limited	Transmission Licensee	NRRGP1TL	26-04-2019	0	272.92
154	NRSS XXIX Transmission Ltd.	Transmission Licensee	NRRN29TL	05-06-2015	0	853.62
155	NRSS XXXI (B) Transmission Ltd.	Transmission Licensee	NRR31BTL	23-11-2016	0	577.6
156	NRSS XXXVI Transmission Ltd.	Transmission Licensee	NRRN36TL	14-06-2017	0	225
157	Parbati Koldam Transmission Company LTD.	Transmission Licensee	NRRPK1TL	11-02-2014	0	457.92
158	PATRAN TRANSMISSION COMPANY LIMITED	Transmission Licensee	NRRPT1TL	07-05-2016	0	0.1
159	Power Grid Corporation India Ltd.	Transmission Licensee	NRRPG1TL	09-06-2011	0	52670.35

160	Power Transmission corporation of Uttarakhand Ltd.	Transmission Licensee	NRRUT1TL	29-09-2016	0	178.48
161	POWERGRID AJMER PHAGI TRANSMISSION LIMITED	Transmission Licensee	NRRPAPTL	07-03-2022	0	268.8
162	Powergrid Aligarh Sikar Transmission Limited	Transmission Licensee	NRRPASTL	08-08-2023	0	0
163	Powergrid Bhadla Transmission Limited	Transmission Licensee	NRRPB2TL	27-04-2023	0	0
164	POWERGRID BIKANER TRANSMISSION SYSTEM LIMITED	Transmission Licensee	NRRPB1TL	14-09-2022	0	1353.32
165	POWERGRID Fatehgarh Transmission Limited	Transmission Licensee	NRRPF1TL	13-07-2021	0	370.37
166	Powergrid Himachal Transmission Limited	Transmission Licensee	NRRJP1TL	16-05-2011	0	448.95
167	POWERGRID KALA AMB Transmission Ltd.	Transmission Licensee	NRRPGKTL	03-07-2017	0	2.47
168	Powergrid Khetri Transmission System Limited	Transmission Licensee	NRRKT1TL	26-07-2021	0	448.2
169	POWERGRID NARELA TRANSMISSION LIMITED	Transmission Licensee	NRRPN1TL	02-02-2024	0	0
170	POWERGRID NEEMUCH TRANSMISSION LIMITED	Transmission Licensee	NRRPNTTL	20-02-2024	0	116.2
171	POWERGRID RAMGARH TRANSMISSION LIMITED	Transmission Licensee	NRRPR1TL	27-06-2023	0	188.12
172	POWERGRID SIKAR TRANSMISSION LIMITED	Transmission Licensee	NRRPS1TL	24-05-2024	0	0
173	POWERGRID UNCHAHAR TRANSMISSION Ltd.	Transmission Licensee	NRRPU1TL	31-03-2017	0	106.74
174	Powergrid Varanasi Transmission System Limited	Transmission Licensee	NRRPV1TL	14-07-2021	0	189.42
175	POWERLINKS Transmission Limited	Transmission Licensee	NRRPL1TL	07-04-2010	0	1224.11
176	RAPP Transmission Company Ltd.	Transmission Licensee	NRRRA1TL	29-09-2015	0	201.6

Note :

1. Malana -II HPS (Registration No - NRRMA2SL) has been de- registered from 05.12.2019 due to change in control area from NRLDC to HP SLDC
2. Mahoba Solar (UP) Pvt Ltd. has been registered as Adani Renewable Energy (RJ) Limited Rawara (NRRAS1GN)
3. Name of Kilaj Solar (Maharashtra) Private Limited Rawara has been changed to Adani Solar Enqrqy Four Private Limited. Rawara
4. Name of 'Jaypee Powergrid Limited' has been changed to 'Powergrid Himachal Transmission Limited'
5. Name of 'SB ENERGY FOUR PRIVATE LIMITED, Bhadla,' has been changed to 'Adani Solar Energy Jodhpur Five Private Limited' vide letter dated 12.04.2022
6. Name of 'SB Energy Six Private Limited (SPD)' has been changed to 'Adani Solar Energy RJ One Private Limited' vide letter dated 12.04.2022
7. Name of "Adani Solar Enqrqy Four Private Limited Rawara" has been changed to Adani Solar Energy Four Limited, Rawara on dated 07.09.2022
8. Name of "Devikot Solar Power Plant NTPC Ltd" has been changed to "Devikot Solar Power Plant NGEL" on dated 15.05.2023
9. Name of "Nidan Solar Power Plant NTPC LTD" has been changed to "Nidan Solar Power Plant NGEL" on dated 15.05.2023
10. Name of "Nokhra Solar Plant NTPC LTD" has been changed to "Nokhra Solar Plant NGEL" on dated 15.05.2023
11. Name of "Kolayat Solar Power Plant NTPC LTD" has been changed to "Kolayat Solar Power Plant NGEL" on dated 26.06.2023
12. Name of "SBSR Power Cleantech Eleven Private Limited, Bikaner" has been changed to "Adani Solar

NRPC

Sub: Medical Bill reimbursement req.

SM,

The medical bill of my mother are attached herewith for necessary action please.



10/6/24  
Sunny Mann  
JSH

~~DDO~~!

Jugal Kumar  
10/06/2024

SH. Ravinder : for necessary action.

**CENTRAL GOVERNMENT HEALTH SCHEME**  
**MEDICAL REIMBURSEMENT CLAIM FORM**

(To be filled up by the Principal Card holder in **BLOCK LETTERS**)

1. (a) Name of the Principal CGHS Card Holder : Sunny Mann  
(b) CGHS Ben ID No. : 5179513  
(c) Employee Code No. :  
(d) Ward Entitlement – Pvt./Semi-Pvt./General : General ward  
(e) Full Address : H.No. 364, Kheda Khurd  
Delhi - 110082  
(f) Mobile telephone No. and e-mail address, if any : 9964880380
2. (a) Patient's Name : Shakuntla  
(b) Patient's CGHS Ben ID No. : 5179515  
(c) Relationship with the Principal CGHS card holder : Mother
3. Name & address of the hospital / diagnostic center / imaging center where treatment is taken or tests done: MAX Super Speciality Hospital, Shalimar Bagh, Delhi
4. Whether the hospital/diagnostic/imaging center is empanelled under CGHS :  Yes/No
5. Treatment for which reimbursement claimed  
(a) OPD Treatment /Test & investigations :  
(b) Indoor Treatment :
6. Whether treatment was taken in emergency :  Yes/No
7. Whether prior permission was taken for the treatment : Yes/No
8. Whether subscribing to any health/medical insurance scheme, If yes, amount claimed/received : Yes/No
9. Details of Medical Advance taken, if any : NIL
10. **Total amount claimed**  
(a) OPD Treatment :  
(b) Indoor Treatment :  
(c) Tests/Investigation : 5,92,541/-
11. Name of the Bank : PNB SB A/c No.: 46070010017660  
Branch MICR Code: 115024425 IFSC Code: PUNB0460700

**DECLARATION**

I hereby declare that the statements made in the application are true to the best of my knowledge and belief and the person for whom medical expenses were incurred is wholly dependent on me. I am a CGHS beneficiary and the CGHS card was valid at the time of treatment. I agree for the reimbursement as is admissible under the rules.

Date : 10/06/2024

Place : Delhi

Signature of the Principal CGHS card holder





**EMERGENCY CERTIFICATE**

Max Super Speciality Hospital  
Shalimar Bagh

31603

This is to certify that Mr./Mrs./Ms. Shakuntla

Age/Sex 62y/F S/o/D/o/W/o \_\_\_\_\_

I.P. No. 326379 Reg. No. SHBG-575187 was admitted in this

hospital on 3 May 2024 in emergency condition.

He/She is / was suffering from HF, EF, EF > 5% LPO, CHF

and got discharged / Dama/Lama/DOR/Expired on 08 May 2024

He/She has been under the care of Doctor Dr Chandrashekhar

Date of emergency certificate issued 08 May 2024

Consultant Name Dr Chandrashekhar

Signature of Consultant Dr. [Signature]

Unit/Department \_\_\_\_\_

DMC Reg.No. DMC - 5685

**Dr. Chandrashekhar**  
MBBS, MD, DM (Cardiology)  
FSCAI (USA), FACC (USA), FESC (EUROPE), FCSI  
Associate Director - Interventional Cardiology  
Mobile No. : +91-9560401055, 6368068204  
Max Super Speciality Hospital, Shalimar Bagh  
DMC Regn. No. - 5185



For Max Super Speciality Hospital,  
Shalimar Bagh, Delhi





# MAX

Healthcare

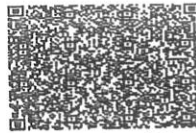

## Bill of Supply Inpatient Bill for Corporate (Summary)

<b>IPID</b> :	326379	<b>MaxID</b> :	SHBG .0000575187
<b>Patient Name</b> :	MRS SHAKUNTLA .	<b>BillNo</b> :	SBIC381789
<b>PatientAddress</b> :	H NO 364 KHERA KHURD New Delhi, Khera Khurd, DELHI, 110082, India	<b>Bill Date</b> :	08/05/2024 11:58
<b>Patient PAN/ Form 60</b> :	SHBG/03-05-2024/326379	<b>Admit Date&amp;Time</b> :	03/05/2024 0:37
<b>Patient State</b> :		<b>Discharge Date&amp;Time</b> :	08/05/2024 11:58
<b>Bed</b> :	SB-CCU-2FLR-02	<b>PAN No.</b> :	AADCM0815B
<b>Doctor</b> :	Chandrashekhar and Team	<b>GSTN No.</b> :	07AADCM0815B1Z4
<b>Company</b> :	CGHS Others/Cash (SHB)	<b>Place of Supply</b> :	DELHI-(07)
<b>Company Cr. Limit</b> :		<b>SACCODE</b> :	999311
<b>CompGSTNNo.</b> :		<b>GST Bill No.</b> :	MS24ID0000002478
<b>Str</b> :			

SI.No.	Service Name	Amount(Rs.)	Discount(Rs.)	Amount(Rs.)
1 ✓	Coronary Angiography(CGHS) (50%) (Four Bed) 601	5,951.50	0.00	5,951.50
2 ✓	ICD Combo Device (CGHS) (100%) (Four Bed)	53,100.00	0.00	53,100.00
3 ✓	TPI (Temporary Cardiac Pacing) Single chamber (CGHS) (50%) (Four Bed) 558	8,640.00	0.00	8,640.00
4 ✓	Drugs	1,569.68	0.00	1,569.68
5	Medical Consumable	523,280.00	0.00	523,280.00
6	Room Rent			0.00
<b>Grand Total :</b>		<b>592,541.18</b>	<b>0.00</b>	<b>592,541.18</b>

Patient Name: MRS SHAKUNTLA  
 Bill Date: 08/05/2024 11:58:30 AM

Patient Name: MRS SHAKUNTLA  
 Bill Date: 08/05/2024 11:58:30 AM

Patient Name: MRS SHAKUNTLA  
 Bill Date: 08/05/2024 11:58:30 AM

**Max Super Speciality Hospital, Shalimar Bagh**  
 FC - 50, C & D Block, Shalimar Bagh,  
 New Delhi - 110 088  
 For medical service queries or appointments,  
 call: +91-11-6642 2222, 7194 1000  
 www.maxhealthcare.in

**Max Healthcare Institute Limited**  
 Regd. Office: 401, 4th Floor, Man Excellence, S. V. Road,  
 (West), MS24ID0000002478 - 400 004  
 T: +91-22 2610 0461/62  
 E: secretarial@maxhealthcare.com  
 (CIN: L72200MH2001PLC322854)

Print Date: 08/05/2024

IPID: 326379

GST Bill No. MS24ID0000002478 Bill Date: 08/05/2024 11:58



MC-2262

H-2013-0177  
15<sup>th</sup> Sep'22 - 7<sup>th</sup> May'26  
Since 8<sup>th</sup> May 2013

Sl.No.	Service Name	Amount(Rs.)	Discount(Rs.)	Amount(Rs.)
--------	--------------	-------------	---------------	-------------

**Deposit Details :**

SNo.	Date	GSTSeriesNo.	Amount
1	3/5/2024	MS24ED0000000831	20,000.00
2	4/5/2024	MS24IF0000002827	1,50,000.00
3	4/5/2024	MS24IF0000002828	20,000.00
4	6/5/2024	MS24IF0000002972	1,00,000.00
5	6/5/2024	MS24IF0000002979	1,00,000.00
6	6/5/2024	MS24IF0000002989	50,000.00
7	6/5/2024	MS24IF0000002990	1,00,000.00
8	6/5/2024	MS24IF0000002991	30,000.00
9	8/5/2024	MS24IF0000003145	22,541.00

**Total Deposit Amount : 592,541.00**

 Patient Name: MRS SHAKUNTLA  
 Bill Date: 5-8-2024 11:58:34AM

 Patient Name: MRS SHAKUNTLA  
 Bill Date: 5-8-2024 11:58:34AM

**Bill Amount: 592,541.18**  
**Deposit: 592,541.00**
**Net Amount to be paid by patient : 0.18**

( Amount includes discount (if any) as per Agreement )

Aman Singh

**Patient Care Coordinator**

**Bill of Supply Inpatient Bill for Corporate (Detailed)**

**IPID** : 326379  
**Patient Name** : MRS SHAKUNTLA  
**Patient Address** : H NO 364 KHERA KHURD New Delhi, Khera Khurd, DELHI, 110082, India  
**Patient PAN/ Form 60** : SHBG/03-05-2024/326379  
**Bed** : SB-CCU-2FLR-02  
**Doctor** : Chandrashekhar and Team  
**Secondary Doctor** :  
**Company** : CGHS Others/Cash (SHB)

**MaxId** : SHBG .0000575187  
**Admit Date&Time** : 03/05/2024 0:37  
**BillNo** : SBIC381789  
**Bill Date** : 08/05/2024 11:58  
**Discharge Date&Time** : 08/05/2024 11:58  
**PAN No.** : AADCM0815B  
**Place Of Supply** : DELHI-(07)  
**GSTNo.** : 07AADCM0815B1Z4  
**SACCODE** : 999311  
**GST Bill No.** : MS24ID0000002478

**Company GSTNo.** :  
**Company Address** :  
**Company State** :

Sl. No.	Item Name	Item Code	Date	Qty	Unit Price	GST Amt (GST%)	Amount(Rs.)	Discount (Rs.)	Net Amt(Rs.)
1	Coronary Angiography(CGHS) (50%) (Four Bed) CGHS601	3/5/24 0:3	04/05/24 00:	1	5,951.50#		5,951.50	0.00	5,951.50
2	TPI (Temporary Cardiac Pacing) Single chamber(CGHS (50%) (Four Bed) 558	3/5/24 0:3	04/05/24 00:	1	8,640.00#		8,640.00	0.00	8,640.00
3	ICD Combo Device (CGHS) (100%) (Four Bed) CGHS565	3/5/24 0:4	08/05/24 11:	1	53,100.00#		53,100.00	0.00	53,100.00
<b>Sub Total :</b>							67,691.50	0.00	67,691.50

**Drugs**

4	CONCOR 2.5MG TAB (X10) (Batch : 07AL24024 / DOE : 31-12-25)(Routine)	7/5/24	10	8.59		85.90	0.00	85.90
5	FORXIGA 10MG TAB (1X14) (Batch : FT2401 / DOE : 31-08-26)(Routine)	7/5/24	5	36.29		181.44	0.00	181.44
6	PANTOCID D CAPSULE** (Batch : SIE1531A / DOE : 31-07-25)(Routine)	7/5/24	5	12.00		59.98	0.00	59.98

SHAKUNTLA Bill Date: 5/8/2024 11:58:31AM  
 SHAKUNTLA Bill Date: 5/8/2024 11:58:31AM  
 SHAKUNTLA Bill Date: 5/8/2024 11:58:31AM

ICD - 53,100/-



Sl. No.	Item Name	Item Code	Date	Qty	Unit Price	GST Amt (GST%)	Amount(Rs.)	Discount (Rs.)	Net Amt(Rs.)
7	TEMFIK TR TABLET (Batch : PLWRAU05 / DOE : 30-11-25) (Routine)		7/5/24	10	12.70		127.01	0.00	127.01
							Sub Total :	454.33	
<b>DPCO</b>									
8	ATORVADOC 20MG TAB (1X10) (Batch : E3L0864 / DOE : 31-05-26)(Routine)		7/5/24	5	14.06		70.28	0.00	70.28
9	CLONOTRIL 0.5MG TAB (1X15) (Batch : 2JC6K015, / DOE : 31-10-26)(Routine)		7/5/24	5	3.86		19.32	0.00	19.32
10	CRITICEF 500MG TAB (1X10) (Batch : DB230295 / DOE : 31-10-25)(Routine)		7/5/24	10	57.60		576.02	0.00	576.02
11	EVOFLOX 500MG TAB (1X10) (Batch : 4SB0234 / DOE : 31-01-27)(Routine)		7/5/24	5	10.07		50.34	0.00	50.34
12	LINOMORE 600MG TAB (1X10) (Batch : DMT-1777A / DOE : 30-11-25)(Routine)		7/5/24	10	39.94		399.39	0.00	399.39
							Sub Total :	1,115.35	
<b>Sub Total :</b>							1,569.68	0.00	1,569.68

**Medical Consumable**

13	CPS IMPLANT KIT/GDWR - DISPOSABLE; (410190/404578) - ST. JUDE (Batch : 814-9942835 / DOE : 31-01-26)(Routine)		6/5/24	1	1,680.00		1,680.00	0.00	1,680.00
14	CRT-D COMBO DEVICE - QUADRA ASSURA; MRI DF4; W/O ACCESSORIES; (CD3365-40Q) - ST. JUDE MEDICAL (Batch : 814-8983412 / DOE : 31-03-26)(Routine)		6/5/24	1	414,750.00		414,750.00	0.00	414,750.00
15	DURATA DEFIBRILLATION LEAD- (7120/7121/7122/7170/ 7171/Q) - ST. JUDE (Batch : 814-BNY232861 / DOE : 31-12-26)(Routine)		6/5/24	1	61,600.00		61,600.00	0.00	61,600.00

Max Super Speciality Hospital, Shalimar Bagh

EC - 50, C &amp; D Block, Shalimar Bagh,

Print Date: 08/05/2024 IPID : 326379

 For medical service queries or appointments,  
 call: +91-11-6642 2222, 7194 1000

www.maxhealthcare.in

Max Healthcare Institute Limited

 Regd. Office: 401, 4th Floor, Man Excellence, S. V. Road,  
 Vile Parle (West), Mumbai, Maharashtra - 400 056

 T: +91-22 2610 0461/62  
 E: secretarial@maxhealthcare.com

(CIN: L72200MH2001PLC322854)

GST Bill No: MS24ID0000002478 Bill Date: 08/05/2024 11:58

Page 2 of 4

 H-2013-0177  
 15<sup>th</sup> Sep'22 - 7<sup>th</sup> May'26  
 Since 8<sup>th</sup> May 2013

MC-2262

Sl. No.	Item Name	Item Code	Date	Qty	Unit Price	GST Amt (GST%)	Amount(Rs.)	Discount (Rs.)	Net Amt(Rs.)
16	LEAD INTRODUCER (PLI)- ST JUDE (Batch : 814-10097706 / DOE : 31-10-26)(Routine)		6/5/24	1	1,680.00		1,680.00	0.00	1,680.00
17	LEAD INTRODUCER (PLI)- ST JUDE (Batch : 814-9237174 / DOE : 31-08-26)(Routine)		6/5/24	1	1,680.00		1,680.00	0.00	1,680.00
18	QUARTET LEFT VENTRICULAR (LV) LEAD - (1457Q/1456Q/86;1458 Q/86) - ST. JUDE (Batch : 814-DCC056006 / DOE : 31-01-27)(Routine)		6/5/24	1	29,500.00		29,500.00	0.00	29,500.00
19	TENDRIL STS - CARDIAC PACING LEAD; (2088TC/46/52/58) - ST JUDE MEDICAL (Batch : 14-CPR318875 / DOE : 31-01-27)(Routine)		6/5/24	1	12,390.00		12,390.00	0.00	12,390.00
<b>Sub Total :</b>							523,280.00	0.00	523,280.00
<b>Grand Total :</b>							592,541.18		592,541.18
<b>Total Deposit :</b>							592,541.00		
<b>Net Amount to be Paid by Patient :</b>							0.18		

 Patient Name: MRS SHAKUNTALA  
 Bill Date: 5/8/2024 11:58:34AM

 Patient Name: MRS SHAKUNTALA  
 Bill Date: 5/8/2024 11:58:34AM

 Patient Name: MRS SHAKUNTALA  
 Bill Date: 5/8/2024 11:58:34AM

Handwritten notes:

49.7

523280

4,90,000



Sl. No.	Item Name	Item Code	Date	Qty	Unit Price	GST Amt (GST%)	Amount(Rs.)	Discount (Rs.)	Net Amt(Rs.)
---------	-----------	-----------	------	-----	------------	----------------	-------------	----------------	--------------

**Deposit Details :**

SNo.	Date	ReceiptNo.	Amount
1	3/5/2024	MS24ED0000000831	20,000.00
2	4/5/2024	MS24IF00000002827	150,000.00
3	4/5/2024	MS24IF00000002828	20,000.00
4	6/5/2024	MS24IF00000002979	100,000.00
5	6/5/2024	MS24IF00000002972	100,000.00
6	6/5/2024	MS24IF00000002991	30,000.00
7	6/5/2024	MS24IF00000002989	50,000.00
8	6/5/2024	MS24IF00000002990	100,000.00
9	8/5/2024	MS24IF00000003145	22,541.00
<b>Total Deposit Amount :</b>			<b>592,541.00</b>

Patient Name MRS SHAKUNTLA . Bill Date 5/8/2024 11:58:34AM

Patient Name MRS SHAKUNTLA . Bill Date 5/8/2024 11:58:34AM

Patient Name MRS SHAKUNTLA . Bill Date 5/8/2024 11:58:34AM

 Man Singh  
 Patient Care Coordinator



## TAX INVOICE

(ORIGINAL FOR RECIPIENT)

e-Invoice

IRN : e3ee86311e4be54265578b815309d3c84e7fe-6c16591b9482a54d1fba988635e  
 Ack No. : 132418219610356  
 Ack Date : 6-May-24

**KOX MED & LAB PRIVATE LIMITED**

605, 6th Floor, Magnum Towers-1  
 Golf Course Extension Road, Sector 58  
 Gurgaon Haryana -122011  
 DL NO: 21B: WLF21B2023HR001713, 20B: WLF20B2023HR001725  
 GSTIN/UIN: 06AACCK9179M1ZV  
 State Name : Haryana, Code : 06  
 E-Mail : INFO@KOXMED.COM

Consignee (Ship to)

**Max Healthcare Institute Ltd-Shalimar Bagh**  
 F.C.50, Block ? C& D, Near Kanishka Apartment  
 Shalimar Bagh, New Delhi ? 110088

DL No:104640,41 on Form 20B, 21B  
 GSTIN/UIN : 07AADCM0815B1Z4  
 State Name : Delhi, Code : 07

Buyer (Bill to)

**Max Healthcare Institute Ltd-Shalimar Bagh**  
 F.C.50, Block ? C& D, Near Kanishka Apartment  
 Shalimar Bagh, New Delhi ? 110088

DL No:104640,41 on Form 20B, 21B  
 GSTIN/UIN : 07AADCM0815B1Z4  
 State Name : Delhi, Code : 07

Invoice No. 24-25/KOXG-820	e-Way Bill No. 301772380962	Dated <b>6-May-24</b>
Delivery Note	Mode/Terms of Payment <b>45 Days</b>	
Reference No. & Date.	Other References	
Buyer's Order No.	Dated	
Dispatch Doc No.	Delivery Note Date	
Dispatched through	Destination	

Terms of Delivery

**Pt. Name MRS SHANKUNTLA**  
**DOU 05.05.24**  
**IP NO 326379**  
**CHALLAN NO 814**  
**DR. NAME DR. CHANDRASHEKHAR**

Sl No.	Description of Goods	HSN/SAC	Part No.	Quantity	Rate	per	Disc. %	Amount
1	<b>QUADRA ASSURA (CD3365-40Q)</b> Batch : 8983412 Expiry : 31-Mar-26	90219090		1 Unit 1 Unit	3,95,000.00	Unit		3,95,000.00
2	<b>LEAD 2088-52</b> Batch : CPR318875 Expiry : 31-Jan-27	90330000		1 Unit 1 Unit	10,500.00	Unit		10,500.00
3	<b>LEAD 7122Q</b> Batch : BNY232861 Expiry : 31-Dec-26	90189099		1 Unit 1 Unit	55,000.00	Unit		55,000.00
4	<b>LEAD 1456Q/86</b> Batch : Dcc056006 Expiry : 31-Jan-27	90330000		1 Unit 1 Unit	25,000.00	Unit		25,000.00
5	<b>405108 (INTRODUCER 7F)</b> Batch : 10097706 Expiry : 31-Oct-26	90183990		1 Unit 1 Unit	1,500.00	Unit		1,500.00
6	<b>405112 (INTRODUCER 8F)</b> Batch : 9237174 Expiry : 31-Aug-26	90183990		1 Unit 1 Unit	1,500.00	Unit		1,500.00
7	<b>404578 (GDWR J3 FX 150CM 035 STD G4)</b> Batch : 9942835 Expiry : 31-Jan-26	90183990		1 Unit 1 Unit	1,500.00	Unit		1,500.00
8	<b>GUIDE WIRE-DS2G003/DS2G001/DS2G002</b> Batch : 8207632 Expiry : 28-Feb-26	90183990		1 Unit 1 Unit	8,000.00	Unit	100 %	
9	<b>GUIDE WIRE-DS2G003/DS2G001/DS2G002</b> Batch : 8452676 Expiry : 30-Jun-26	90183990		1 Unit 1 Unit	8,000.00	Unit	100 %	
10	<b>GUIDE WIRE-DS2G003/DS2G001/DS2G002</b> Batch : 8452674 Expiry : 30-Jun-26	90183990		2 Unit 2 Unit	8,000.00	Unit	100 %	
11	<b>CATHETER DS2N021-59</b> Batch : 8955862 Expiry : 28-Feb-26	90183920		1 Unit 1 Unit	8,800.00	Unit	100 %	

continued to page number 2

SUBJECT TO DELHI JURISDICTION

This is a Computer Generated Invoice

**KOX MED & LAB PRIVATE LIMITED**  
 605, 6th Floor, Magnum Towers-1  
 Golf Course Extension Road, Sector 58  
 Gurgaon Haryana -122011  
 DL NO: 21B: WLF21B2023HR001713, 20B: WLF20B2023HR001725  
 GSTIN/UIN: 06AACCK9179M1ZV  
 State Name : Haryana, Code : 06  
 E-Mail : INFO@KOXMED.COM

Invoice No. 24-25/KOXG-820	e-Way Bill No. 301772380962	Dated <b>6-May-24</b>
Delivery Note	Mode/Terms of Payment <b>45 Days</b>	
Reference No. & Date.	Other References	
Buyer's Order No.	Dated	
Dispatch Doc No.	Delivery Note Date	
Dispatched through	Destination	

Consignee (Ship to)  
**Max Healthcare Institute Ltd-Shalimar Bagh**  
 F.C.50, Block ? C & D, Near Kanishka Apartment  
 Shalimar Bagh, New Delhi ? 110088  
 DL No:104640,41 on Form 20B, 21B  
 GSTIN/UIN : 07AADCM0815B1Z4  
 State Name : Delhi, Code : 07

Terms of Delivery  
**Pt. Name MRS SHANKUNTLA**  
**DOU 05.05.24**  
**IP NO 326379**  
**CHALLAN NO 814**  
**DR. NAME DR. CHANDRASHEKHAR**

Buyer (Bill to)  
**Max Healthcare Institute Ltd-Shalimar Bagh**  
 F.C.50, Block ? C & D, Near Kanishka Apartment  
 Shalimar Bagh, New Delhi ? 110088  
 DL No:104640,41 on Form 20B, 21B  
 GSTIN/UIN : 07AADCM0815B1Z4  
 State Name : Delhi, Code : 07

Sl No.	Description of Goods	HSN/SAC	Part No.	Quantity	Rate	per	Disc. %	Amount
12	<b>DS2N027-65 (CATHETER DS2N027-65)</b> Batch : 8954245 Expiry : 28-Feb-26	90183920		<b>1 Unit</b> 1 Unit	8,800.00	Unit	100 %	
13	<b>CATHETER DS2C019</b> Batch : 10070649 Expiry : 31-Oct-26	90183920		<b>1 Unit</b> 1 Unit	8,800.00	Unit	100 %	
14	<b>CATHETER 410212</b> Batch : 9182443 Expiry : 31-Jul-26	90183920		<b>1 Unit</b> 1 Unit	8,800.00	Unit	100 %	
15	<b>CATHETER 410212</b> Batch : 9244871 Expiry : 31-Aug-26	90183920		<b>1 Unit</b> 1 Unit	8,800.00	Unit	100 %	
16	<b>CATHETER 410213</b> Batch : 8830924 Expiry : 31-Dec-25	90183920		<b>1 Unit</b> 1 Unit	8,800.00	Unit	100 %	
17	<b>4051L (DISPOSABLE CABLE)</b> Batch : 2312507	85441990		<b>1 Unit</b> 1 Unit	1,100.00	Unit	100 %	
18	<b>SLITTER DS2A003</b> Batch : 9076978 Expiry : 31-May-26	90183990		<b>1 Unit</b> 1 Unit	8,000.00	Unit	100 %	
<b>OUTPUT IGST</b>								4,90,000.00
<b>Total</b>								<b>5,23,280.00</b>

Amount Chargeable (in words) **Five Lakh Twenty Three Thousand Two Hundred Eighty INR Only** E. & O.E

HSN/SAC	Taxable Value	IGST		Total Tax Amount
		Rate	Amount	
90219090	3,95,000.00	5%	19,750.00	19,750.00
90330000	35,500.00	18%	6,390.00	6,390.00
90189099	55,000.00	12%	6,600.00	6,600.00
90183990	4,500.00	12%	540.00	540.00
90183920		12%		
85441990		12%		
<b>Total</b>			<b>33,280.00</b>	<b>33,280.00</b>

Tax Amount (in words) : **Thirty Three Thousand Two Hundred Eighty INR Only**

Remarks:  
 INVOICE NO 820

Declaration  
 1) We are Registered as MSME vide UDYAM REGISTRATION NUMER-UDYAM-DL-03-0005875. Interest and other Provisions of MSME Act apply on Late Payments.  
 2) Provisions of GST law requires input credit to be reversed if the payment is not made within 180 days from

Company's Bank Details  
 Bank Name : **ICICI BANK LTD A/C 661451200008**  
 A/c No. : **661451200008**  
 Branch & IFS Code : **QUTAB ENCLAVE, DLF PHASE-1 & ICIC0006614**  
 for KOX MED & LAB PRIVATE LIMITED

Authorised Signatory



## e-Way Bill

e-Way Bill

Doc No. : Tax Invoice - 24-25/KOXG-820  
Date : 6-May-24

IRN : e3ee86311e4be54265578b815309d3c84e7fe6c16591b9482a54d1fba988635e  
Ack No. : 132418219610356  
Ack Date : 6-May-24



## 1. e-Way Bill Details

e-Way Bill No. : 301772380962 Mode : 1 - Road Generated Date : 6-May-24 3:15 PM  
Generated By : 06AACCK9179M1ZV Approx Distance : 40 KM Valid Upto : 7-May-24 11:59 PM  
Supply Type : Outward-Supply Transaction Type : Regular

## 2. Address Details

**From**  
KOX MED & LAB PRIVATE LIMITED  
GSTIN : 06AACCK9179M1ZV  
Haryana

**To**  
Max Healthcare Institute Ltd-Shalimar Bagh  
GSTIN : 07AADCM0815B1Z4  
Delhi

**Dispatch From**  
605, 6th Floor, Magnum Towers-1, Golf Course Extension  
Road, Sector 58, Gurgaon Haryana -122011, DL NO: 21B:  
WLF21B2023HR001713, 20B: WLF20B2023HR001725

**Ship To**  
F.C.50, Block ? C & D, Near Kanishka Apartment, Shalimar  
Bagh, New Delhi ? 110088

## 3. Goods Details

HSN Code	Product Name & Desc	Quantity	Taxable Amt	Tax Rate (%)
90219090	QUADRA ASSURA (CD3365-40Q) & QUADRA ASSURA (CD3365-40Q)	1 UNT	3,95,000.00	5
90330000	LEAD 2088-52 & LEAD 2088-52	1 UNT	10,500.00	18
90189099	LEAD 7122Q & LEAD 7122Q	1 UNT	55,000.00	12
90330000	LEAD 1456Q/86 & LEAD 1456Q/86	1 UNT	25,000.00	18
90183990	INTRODUCER 7F & INTRODUCER 7F	1 UNT	1,500.00	12
90183990	INTRODUCER 8F & INTRODUCER 8F	1 UNT	1,500.00	12
90183990	GDWR J3 FX 150CM 035 STD G4 & GDWR J3 FX 150CM 035 STD G4	1 UNT	1,500.00	12
90183990	GUIDE WIRE-DS2G003/DS2G001/DS2G002 & GUIDE WIRE-DS2G003/DS2G001/DS2G002	1 UNT		12
90183990	GUIDE WIRE-DS2G003/DS2G001/DS2G002 & GUIDE WIRE-DS2G003/DS2G001/DS2G002	1 UNT		12
90183990	GUIDE WIRE-DS2G003/DS2G001/DS2G002 & GUIDE WIRE-DS2G003/DS2G001/DS2G002	1 UNT		12
90183920	CATHETER DS2N021-59 & CATHETER DS2N021-59	2 UNT		12
90183920	CATHETER DS2N027-65 & CATHETER DS2N027-65	1 UNT		12
90183920	CATHETER DS2C019 & CATHETER DS2C019	1 UNT		12
90183920	CATHETER 410212 & CATHETER 410212	1 UNT		12
90183920	CATHETER 410212 & CATHETER 410212	1 UNT		12
90183920	CATHETER 410213 & CATHETER 410213	1 UNT		12
85441990	DISPOSABLE CABLE & DISPOSABLE CABLE	1 UNT		12
90183990	SLITTER DS2A003 & SLITTER DS2A003	1 UNT		12

Tot. Taxable Amt : 4,90,000.00 Other Amt : Total Inv Amt : 5,23,280.00  
IGST Amt : 33,280.00

## 4. Transportation Details

Transporter ID :  
Name :  
Doc No. :  
Date : 6-May-24

## 5. Vehicle Details

Vehicle No. : DL06SZX2074 From : HARYANA CEWB No. :

**Discharge Summary Clinical Cardiology****Patient Demography Details :**

<b>Name</b> : Shakuntla .	<b>Patient ID</b> : SHBG.575187	<b>IP No.</b>	: 326379
<b>DOB</b> : 01 MAY, 1962	<b>Age/Gender</b> : 62 Years/FEMALE	<b>Primary Consultant</b>	: Chandrashekhar
<b>DOA</b> : 03 MAY, 2024 00:37	<b>Ward</b> : SHBG-2NDFLR-CCU	<b>Treating Consultant</b>	: Rameshwar Lal Bishnoi
<b>Address</b> : H NO 364 KHERA KHURD , Khera Khurd, DELHI, 110082		<b>Mobile No.</b>	: 9964880380

**Date and Time of Discharge** : 08 MAY, 2024 09:00**Diagnosis:**

HFrEF (Improved)  
DCMP / LBBB  
SEVERE LV DYSFUNCTION, LVEF ~ 20%  
CAG (05/05/2024) - NORAMAL EPICARDIAL CORONARIES with ECTATIC RCA  
P/CRT-D - QUADRA ASSURA on 05/05/2024

**Presenting Complaints:**

-Difficulty in breathing since past one month which worsened and became severe X 1 day prior to admission  
-Dyspnea on exertion  
  
no known comorbidity

**On Examination:**

Primary survey  
Airway assessment : patent  
  
Breathing assessment  
  
Respiration(RR/min) :18/min  
Laboured : no  
SPO2 : 92 % on room air  
  
Circulation

For post-hospital care at home, call Max@Home at 8744 888 888 (24x7 helpline). Services include Critical Care@home Nursing Healthcare Attendant, Physio-therapy, X-Ray, Sample Collection, Medicine Delivery, Medical Equipment and more

**IN CASE OF ANY EMERGENCY PLEASE CONTACT 01166422222/ 011-71942222/ 011-40554055**

"This is a computer generated document and does not require any signature"

Pulse :99/min

BP :160/100 mmHg

Peripheral pulses : present

Temperature :98 f

ECG :sinus rhythm with LBBB

GRBS : 148mg/dl

Pupils :

right eye : NSNR

left eye : NSNR

Secondary survey

HEENT : no pallor, no icterus, no previous headinjuries, tongue moist, neck movements active

Chest : B/L crepts present

CVS : S1 S2 present , no murmur

Abd : soft, non tender, bowel sounds present

Ext : warm, no pitting pedal edema

Neuro : conscious, oriented, GCS-15/15, no abnormal movements

#### Course in Hospital:

Patient was admitted with above mentioned history and complaints. Routine investigations were done. Patient was initially evaluated in emergency and then shifted to critical care unit for further management and care. Echo was done that Global LV hypokinesia. Aortic valve thick. Severe LV systolic dysfunction. LVEF 20%. grade II LV diastolic dysfunction. Patient was initially managed with decongestive therapy, antiplatelet, statin and other supportive medications. After stabilisation and after informed written consent taken CAG was done on 05/05/2024 which revealed NORAMAL EPICARDIAL CORONARIES with ECTATIC RCA. With another written and informed consent CRT -D done on 05.05.2024. Patient responded well to the given treatment. Regular monitoring was done. Now patient is being discharged in stable condition with further follow up advice.

#### Condition on Discharge:

stable

#### Lab Result:

All investigation reports were handed over to the patient

#### Procedure:

For post-hospital care at home, call Max@Home at 8744 888 888 (24x7 helpline). Services include Critical Care@hc Nursing Healthcare Attendant, Physio-therapy, X-Ray, Sample Collection, Medicine Delivery, Medical Equipment and more

**IN CASE OF ANY EMERGENCY PLEASE CONTACT 01166422222/ 011-71942222/ 011-40554055**

"This is a computer generated document and does not require any signature"

Max Super Speciality Hospital, Shalimar Bagh

FC - 50, C & D Block, Shalimar Bagh,  
New Delhi - 110 088

For medical service queries or appointments,  
call: +91-11-6642 2222, 7194 1000

www.maxhealthcare.in

Max Healthcare Institute Limited

Regd. Office: 401, 4th Floor, Man Excellenza, S. V. Road,  
Vile Parle (West), Mumbai, Maharashtra - 400 056

T: +91-22 2610 0461/62

E: secretarial@maxhealthcare.com

(CIN: L72200MH2001PLC322854)



MC-2262



H-2013-0177  
15<sup>th</sup> Sep'22 - 7<sup>th</sup> May'26  
Since 8<sup>th</sup> May 2013

Echo done on 03.05.2024.  
LAE. LVE.  
Global LV hypokinesia.  
Aortic valve thick.  
Severe LV systolic dysfunction  
LVEF 20%  
Grade II LV diastolic dysfunction  
Trace AR.  
Mild MR.  
Normal RV function (tapse 19).  
RA, RV normal.  
Mild TR, PASP - 30mmhg  
IVC normal size with normal respiratory variation  
No intracavitary mass/clot/pericardial effusion.

---

**PROCEDURE NOTES : CRT-D**

Name of the Procedure done : CRT-D ✓  
Name of the surgeon : Dr rameshwar bishnoi  
Procedure: CRT- D implantation

Lt subclavian venous access was taken. ICD lead positioned at RV apex, RA lead positioned at RA appendage.,  
Lead parameters were satisfactory. Pulse generator was connected to leads.  
Pocket closed in layers.  
No procedural complication.

Device-quadra assura CRT-D

RA lead- P wave 4 mv; impedance-450 ohm; threshold-0.5 volt @ 0.4 sec pulse width

ICD lead - R wave 12mv; impedance-500 ohm; threshold-0.5 volt @ 0.4 sec pulse width

LV lead - R -wave 12 mv, impedance 700 ohm ,threshold -0.75 volt @ 0.4 sec pulse

---

**Medications During Stay:**

---

For post-hospital care at home, call Max@Home at 8744 888 888 (24x7 helpline). Services include Critical Care@home Nursing Healthcare Attendant, Physio-therapy, X-Ray, Sample Collection, Medicine Delivery, Medical Equipment and more.

---

**IN CASE OF ANY EMERGENCY PLEASE CONTACT 01166422222/ 011-71942222/ 011-40554055**

---

"This is a computer generated document and does not require any signature"

**Max Super Speciality Hospital, Shalimar Bagh**  
FC - 50, C & D Block, Shalimar Bagh,  
New Delhi - 110 088  
For medical service queries or appointments,  
call +91-11-6642 2222, 7194 1000  
www.maxhealthcare.in

**Max Healthcare Institute Limited**  
Regd. Office: 401, 4th Floor, Man Excellenza, S. V. Road,  
Vile Parle (West), Mumbai, Maharashtra - 400 056  
T: +91-22 2610 0461/62  
E: secretarial@maxhealthcare.com  
(CIN: L72200MH2001PLC322854)



MC-2262

H-2013-0177  
15<sup>th</sup> Sep'22 - 7<sup>th</sup> May'26  
Since 8<sup>th</sup> May 2013



- 1) ACETYLSALICYLIC ACID UD 75MG TAB 75MG PO QHS(DAILY 10:00PM)
  - 2) ATORVASTATIN UD 40MG TAB 40MG PO QHS(DAILY 10:00PM)
  - 3) AZMARDA 50MG TAB 1TABLET PO BID(10&22HRS)
  - 4) BUDECORT RESPULE 1MG 1x5 (New) INJ 1 RESP INHL BID(10&22HRS) RINSE MOUTH AFTER NEBS
  - 5) CLONAZEPAM UD 0.5MG TAB 0.5MG PO QHS(DAILY 10:00PM)
  - 6) CORBIS 2.5MG (1X15)\* TAB 1TABLET PO BID(10&22HRS)
  - 7) DUOLIN RESPULE 2.5ML AMP CAP,INHL 2.5ML INHL TID(6,14&22HRS)
  - 8) EPLERENONE UD 25MG TAB 25MG PO QDAILY(10HRS)
  - 9) FORXIGA 10MG TAB 1TABLET PO QDAILY(10HRS)
  - 10) LACTULOSE UD 10GM 450ML SYRUP 10GM PO QHS(DAILY 10:00PM)
  - 11) LASIX 4ML\* VIAL 20 MG IV BID(08&20HRS)
  - 12) LINEZOLID UD 600MG TAB,ORAL 600MG PO BID(10&22HRS)
- ## Indication: Others : POST CRTD## Drug  
 Justification: Empirical##Risk Category:Risk  
 Category 1
- 13) ONDANSETRON 2MG/ML 2ML UD AMP INJ,SOLN 2MG/1ML IV PRN SOS/PRN FOR VOMITTING. Max Dosage - 32 MG / DAY  
 SOS/PRN FOR VOMITTING. Max Dosage - 32 MG / DAY
  - 14) PANTOPRAZOLE UD 40MG TAB,EC 40MG PO QAM(06HRS)
  - 15) TARGOCID 400MG INJ INJ,SUSP 400MG IV QHS(DAILY 10:00PM)
  - 16) TAZACT 4.5GM VIAL VIAL 4.5GM IV Q8H(6,14&22 HRS)
  - 17) ULTRACET (1X15)\* TAB 1 TABLET PO BID(10&22HRS)

**Medications on Discharge:**

TAB CORBIS 2.5 MG TWICE DAILY ✓  
 TAB EPLEBLESS 25 MG ONCE DAILY ✓ 10 PM.  
 TAB LV EFFECT 10 MG ONCE DAILY ✓ 10 AM.  
 TAB AVAS 20 MG AT BED TIME •  
 TAB CLONAFIT 0.5 MG AT BED TIME •  
 TAB VELOZ D TWICE DAILY •  
 CAP NEUROKIND GOLD ✗ ———  
 TAB MYMARDA 50 MG TWICE DAILY ✓

TAB CEFTUM 500 MG TWICE DAILY X 5 DAYS ✓  
 TAB LINEZOLID 600 MG TWICE DAILY X 5 DAYS ✓  
 TAB LEVOFLOX 500 MG ONCE DAILY X 5 DAYS ✓  
 TAB ULTRACET TWICE DAILY X 5 DAYS ✓

For post-hospital care at home, call Max@Home at 8744 888 888 (24x7 helpline). Services include Critical Care@home, Nursing Healthcare Attendant, Physio-therapy, X-Ray, Sample Collection, Medicine Delivery, Medical Equipment and more.

**IN CASE OF ANY EMERGENCY PLEASE CONTACT 01166422222/ 011-71942222/ 011-40554955**

"This is a computer generated document and does not require any signature"

Max Super Speciality Hospital, Shalimar Bagh  
 EC - 50, C & D Block, Shalimar Bagh,  
 New Delhi - 110 088  
 For medical service queries or appointments,  
 call: +91-11-6642 2222, 7194 1000  
 www.maxhealthcare.in

Max Healthcare Institute Limited  
 Regd. Office: 401, 4th Floor, Man Excellenza, S. V. Road,  
 Vile Parle (West), Mumbai, Maharashtra - 400 056  
 T: +91-22 2610 0461/62  
 E: secretarial@maxhealthcare.com  
 (CIN: L72200MH2001PLC322854)



H-2013-0177  
 15<sup>th</sup> Sep'22 - 7<sup>th</sup> May'26  
 Since 8<sup>th</sup> May 2013

MC-2262

SSN No. 170575187 Patient Name: Shakuntla

**Advice:**

DO NOT STOP ANY MEDICATION WITHOUT DOCTOR'S ADVISE

**Follow Up Advice:**

Please follow-up with Dr. Chandrashekhar in Cardiology OPD after 3 days for dressing / SOS.

Please visit the front-office to get your next appointment booked or call at 011-6642-2222.

Avoid changing/stopping medicines without medical guidance.

Patient was verbalized understanding of the discharge instructions.

In case of

- chest pain

- shortness of breath

- BLEEDING / SWELLING / OOZING

Contact max hospital at 011-4055-4055.

I \_\_\_\_\_ have understood and have been given an opportunity to clarify my concerns in the language I/we understand & hereby acknowledge receipt of the discharge summary.

Patient/Attendant \_\_\_\_\_ Nurse \_\_\_\_\_

/es/ Virender Singh Bhati  
Associate Consultant

/es/ Virender Singh Bhati  
Associate Consultant

Entered Date : 07 MAY, 2024 21:49

Signed: 08 MAY, 2024 10:59

Cosigned: 08 MAY, 2024 11:00  
for Chandrashekhar  
Associate Director

Prepared By: Virender Singh Bhati

ADDENDUM (Author: Virender Singh Bhati Entered Date:08 MAY, 2024 11:05 )

KINDLY ADD IN DISCHARGE MEDICATION

SYP POTKLOR 3 TSF BD X 3 DAY WITH FRESH TENDER COCONUT WATER

R/V IN OPD WITH FRESH KFT.REPORTS

/es/ Virender Singh BHATI  
Associate Consultant

Signed: 08 MAY, 2024 11:06

For post-hospital care at home, call Max@Home at 8744 888 888 (24x7 helpline). Services include Critical Care@home, Nursing Healthcare Attendant, Physio-therapy, X-Ray, Sample Collection, Medicine Delivery, Medical Equipment and more

**IN CASE OF ANY EMERGENCY PLEASE CONTACT 01166422222/ 011-71942222/ 011-40554055**

"This is a computer generated document and does not require any signature"

Max Super Speciality Hospital, Shalimar Bagh

FC - 50, C & D Block, Shalimar Bagh,  
New Delhi - 110 088

For medical service queries or appointments,  
call: +91-11-6642 2222, 7194 1000

www.maxhealthcare.in

Max Healthcare Institute Limited

Regd. Office: 401, 4th Floor, Man Excellenza, S. V. Road,  
Vile Parle (West), Mumbai, Maharashtra - 400 056

T: +91-22 2610 0461/62

E: secretarial@maxhealthcare.com

(CIN: L72200MH2001PLC322854)



MC-2262

H-2019-0177  
15<sup>th</sup> Sep'22 - 7<sup>th</sup> May'26  
Since 8<sup>th</sup> May 2013



medical.abbott/manuals



Abbott Medical  
15900 Valley View Court  
Sylmar, CA 91342 USA  
+1 818 362 6822



Abbott

Patient Identification Card



MRS. SHAKUNT LA



medical.abbott/manuals



05-05-2024



DR- CHANDRASHEKHAR



011-49782222

600185481 C

 **Quadra Assura™**

**UDI**   
(01)05414734508292(17)260331(21)8983412

	<b>2026-03-31</b>
<b>REF</b>	CD3365-40Q
<b>SN</b>	8983412

GTIN: 05414734502887 **REF** 2088TC 52 cm  2027-01-31 **SN** CPR318875

  
(01)05414734502887(17)270131(21)CPR318875

TENDRIL™ STS

 St. JUDE MEDICAL

GTIN: 05414734503174 **REF** 7122Q 58 cm  2026-12-31 **SN** BNY232861

  
(01)05414734503174(17)261231(21)BNY232861

DURATA™

 St. JUDE MEDICAL

GTIN: 05414734510158 **REF** 1456Q 86 cm  2027-01-31 **SN** DCC056006

  
(01)05414734510158(17)270131(21)DCC056006

QUARTET™

 St. JUDE MEDICAL





केन्द्रीय सरकार स्वास्थ्य योजना  
CENTRAL GOVERNMENT HEALTH SCHEME



SHAKUNTLA

5179515 - सर्विस / Service

जन्म तिथि / Date of Birth: 01-05-1962

वार्ड / Ward: General

रक्त वर्ग / Blood Group: -

वैधता / Valid Upto: Dec 2026

जारी करने की तिथि / Date of Issue: Dec 2021



8018890327300051795155

निदेशक

निदेशक / Director



केन्द्रीय सरकार स्वास्थ्य योजना  
CENTRAL GOVERNMENT HEALTH SCHEME



SUNNY MANN

5179513 - सर्विस / Service

जन्म तिथि / Date of Birth: 10-06-1993

वार्ड / Ward: General

रक्त वर्ग / Blood Group: -

वैधता / Valid Upto: Dec 2026

जारी करने की तिथि / Date of Issue: Dec 2021



8018890327300051795131

निदेशक

निदेशक / Director



No: 12034/02/2014/Misc/-CGHS D.III  
 Government of India  
 Ministry of Health & Family Welfare  
 Department of Health & Family Welfare  
 CGHS(P)

Nirman Bhawan, New Delhi  
 Dated the 21<sup>st</sup> July, 2014.

**OFFICE MEMORANDUM**

**Sub: Ceiling Rates for reimbursement of the cost of Cardiac pacemaker, AICD, Combo-device, Rotablator and Aortic Stent Graft to beneficiaries of CGHS/CS(MA) Rules.**

With reference to the above mentioned subject the undersigned is directed to draw attention to the Office Memoranda No. S-11011/7/95-CGHS(P) dated 12/6/1996 and 26-164/98-R&H/CGHS/CGHS(P) dated 22/11/1999 vide which ceiling rates and guidelines were prescribed for various types of Pacemakers, Rotablator and AICD and to state that while the ceiling rates for coronary stents have been revised from time to time separately the rates and guidelines for pacemakers, Rotablator and AICD were not revised. The matter has been examined by the Ministry and it has been decided to revise the ceiling rates (incl. of all taxes) for these devices as per the details given below:

1.	Single Chamber Cardiac Pacemaker without rate response -	Rs.34,840/-
2.	Single Chamber Cardiac Pacemaker with rate response	Rs.44,928/-
3.	Dual Chamber Cardiac Pacemaker	Rs.83,200/-
4.	Bi-Ventricular Pacemaker (CRT-P)	Rs.1,95,000/-
5.	Implantable Cardioverter Defibrillator (Single Chamber) (ICD /AICD- Single Chamber)	Rs.1,75,786/-
6.	Implantable Cardioverter Defibrillator (Dual Chamber) (ICD /AICD- Dual Chamber)	Rs.3,75,000/-
7.	Combo Device (CRT-D)	Rs.4,90,000/-
8.	Aortic Stent Graft (expandable, bifurcated and including delivery system)	Rs.4,40,960/-
9.	Rotablator with advancer	Rs.49,920/-
10.	Rotablator Burr	Rs.23,920/-

2. Permission for the above mentioned implants shall be granted on the basis of advice of Govt. cardiologist by CMO in-charge / Additional Director / Joint Director, CGHS in case of pensioners, former Governors, former Vice-Presidents, ex-MPs, Freedom Fighters, etc., by Rajya Sabha / Lok Sabha



the concerned Ministry / Department / Organization in case of service of Government employees, serving employees and pensioners of autonomous bodies covered under CGHS. The reimbursement shall be limited to the ceiling rate or actual rate, whichever may be less.

3. The Warranty terms and conditions as specified by the manufacturer shall be applicable in case of replacement of a device.
4. In case of requests for replacement of a device, a copy of the details of the earlier device as well as a copy of terms and conditions of Warranty shall be enclosed along with the advice of Govt. specialist.
5. A copy of the device 'ID No Sticker' and a copy of terms of warranty shall be enclosed along with the bill of device for reimbursement.
6. In case of implantation of any of the devices in emergency, reimbursement shall be subject to ex-post facto approval by Addl. Director/Joint Director, CGHS of city, in consultation with experts, if necessary.
7. These orders are in supersession of earlier guidelines and ceiling rates issued in this regard.
8. The rates shall be valid for a period of two years or till further revision, whichever may be earlier.
9. This issues with the concurrence of Integrated Finance Division vide CD No C 756 dated 14/07/2014.



(Ravi Kant)  
Under Secretary to Government of India  
011-23061141

To

1. All Ministries / Departments, Government of India
2. Director, CGHS, Nirman Bhawan, New Delhi
3. AD(Hq), CGHS, Bikaner House, New Delhi
4. AdII.DDG(HQ), CGHS, MoHFW, Nirman Bhavan, New Delhi
5. All Additional Directors /Joint Directors of CGHS cities outside Delhi
6. Additional Director (SZ)/ (CZ)/(EZ)/(NZ)/(MSD), MCTC CGHS, New Delhi
7. JD(HQ),/JD (Grievance)/JD(R&H), CGHS Delhi
8. DDG(M)/Addl DDG(SRA), Dte. GHS, MoHFW, Nirman Bhavan, New Delhi
9. Rajya Sabha / Lok Sabha Secretariat, New Delhi
10. Registrar, Supreme Court of India, New Delhi
11. U.P.S.C. Dholpur House, Shahjahan Road, New Delhi.
12. O/o the C&AG, Bahadur Shah Zafar Marg, New Delhi
13. Director, DoP&PW, Lok Nayak Bhavan, Khan Market, New Delhi
14. PPS to Secretary (H&FW)/ Secretary (AYUSH)/ Secretary(HR)/ Secretary(AIDS Control), Ministry of Health & Family Welfare

**Government of India**  
**Ministry of Health and Family Welfare**  
**Department of Health & Family Welfare**  
**Directorate General of CGHS**  
**Office of the Director, CGHS**

No: S-11011/29/2018-CGHS(HEC)/ DIR/CGHS

Nirman Bhawan, New Delhi

Dated the 6<sup>th</sup> August, 2018

**OFFICE MEMORANDUM**

**Subject:-** Revision of ceiling rates for reimbursement of the cost of Cardiac pacemaker , AICD, Combo-device, Rotablator and Aortic Stent Graft for beneficiaries of CGHS/CS(MA) Rules

\*\*\*\*

With reference to the above subject attention is drawn to the OM No 12034/02/2014/Misc./-CGHS D.III dated 22<sup>nd</sup> July 2014 vide which ceiling rates for reimbursement of the cost of Cardiac pacemaker, AICD, Combo-device, Rotablator and Aortic Stent Graft for beneficiaries of CGHS/CS (MA) Rules were prescribed and to state that the matter has been reviewed by the Ministry and it is decided to revise the ceiling rates as per the details given under:

Sr. No.	Cardiac Device	Ceiling Rate
1	Single Chamber Cardiac Pacemaker without Rate Response	Rs. 34,840/- + GST
2	Single Chamber Cardiac Pacemaker with Rate Response	Rs. 44,928/-+ GST
3	Dual Chamber Cardiac Pacemaker	Rs.83,200/-+ GST
4	Bi-Ventricular Cardiac Pacemaker	Rs.1,95,000/-+ GST
5	Implantable Cardioverter Defibrillator (Single Chamber) (ICD/AICD-Single Chamber)	Rs.1,75,786/-+ GST
6	Implantable Cardioverter Defibrillator (Dual Chamber) (ICD/AICD-Single Chamber)	Rs. 3,75,000/-+ GST
7	Combo Device (CRT-D)	Rs. 4,90,000/-+ GST
8	Aortic Stent Graft (expandable, bifurcated and including delivery system)	Rs. 4,40,960/- + GST
9	Rotablator with Advancer	Rs.49,920/-+ GST
10	Rotablator Burr	Rs.23,920/-+ GST

1/11/18



2. Other terms and conditions prescribed under OM No 12034/02/2014/Misc./-CGHS D.III dated 22<sup>nd</sup> July 2014 shall remain unchanged.

3. These rates shall remain valid till the rates for the above devices are notified by National Pharmaceutical Pricing Authority (NPPA).

4. Issued with the concurrence of SS&FA, Ministry of Health & Family Welfare vide CD - No 1295 dated 25.07.2018.

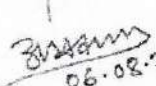
  
06.08.2018  
(Dr. Atul Prakash)  
Director, CGHS

To:

- 1 All Ministries / Departments, Government of India
- 2 Director, CGHS, Nirman Bhawan, New Delhi
- 3 Addl. DDG (HQ)/All Additional Directors /Joint Directors of CGHS cities outside Delhi
- 4 All Pay & Accounts Officers under CGHS
- 5 Additional Director (Hqrs) / Additional Director (SZ)/ (CZ)/(EZ)/(NZ), CGHS, New Delhi
- 6 JD (Gr.)/JD(R&H), CGHS Delhi
- 7 CGHS Desk-I/Desk-II/CGHS-I/CGHS-II, Dte.GHS, Nirman Bhawan, New Delhi
- 8 Estt.I/ Estt.II/ Estt.III/ Estt.IV Sections, Ministry of Health & Family Welfare
- 9 Admn.I / Admn.II Sections of Dte.GHS
- 10 Rajya Sabha / Lok Sabha Secretariat
- 11 Registrar, Supreme Court of India /Punjab & Haryana High Court, Chandigarh
- 12 U.P.S.C.
- 13 Finance Division
- 14 Deputy Secretary (Civil Service News), Department of Personnel & Training, 5th Floor, Sardar Patel Bhawan, New Delhi.
- 15 PPS to Secretary (H&FW)/ Secretary (AYUSH)/ Secretary (HR)/ Secretary(AIDS Control), Ministry of Health & Family Welfare
- 16 PPS to DGHS /SS&MD, NRHM / AS (H) /AS & DG (CGHS)
- 17 Shri Umraomal Purohit, Secretary, Staff Side, 13-C, Ferozshah Road, New Delhi
- 18 All Staff Side Members of National Council (JCM) (as per list attached)
- 19 Office of the Comptroller & Auditor General of India, 10 Bahadur Shah Zafar Marg, New Delhi
- 20 All Offices / Sections / Desks in the Ministry
21. UTI-ITSC , 153/1, First floor, Old Madras Road, Ulsoor, Bengaluru-560008.
- 22 Nodal Officer, MCTC, CGHS with a request to upload a copy of OM on CGHS Web-site
- 23 Office Order folder

हिंदी में काम करना सरल है, आवश्यकता है एक शुरुआत की।

मिसिल संख्या/ File No.S- 7711/2024/CGHS HQ/R&H/1044

भारत सरकार  
अपर निदेशक का कार्यालय  
के.स.स्वा.यो. (मु.), प्रति.एवं अस्पताल अनुभाग  
सै.- 13, रा.कृ.पु., नई दिल्ली - 110066



GOVT. OF INDIA  
OFFICE OF THE ADDITIONAL DIRECTOR  
C. G. H. S. (HQ), R&H Section  
Sector - 13, Rama Krishna Puram  
New Delhi - 110066

दूरभाष: 011-20863437

दिनांक 30.07.2024

**Sub: - Clarification regarding reimbursement of medical claim in r/o Smt. Shakuntla Devi M/o Sh. Sunny Mann.**

**Ref: Your Letter No.CEA-GO-17-15(12)/11/2023-NRPC, Dated: 24.06.2024.**

Kindly refer to your letter on the subject noted above and as it is a diagnosed case of Heart failure with reduced EF, DCMP, LBBB, Severe LV dysfunction, LVEF-25%.

Ex-post facto approval is hereby granted for :-

1. CRT-D implantation is listed CGHS procedure (CGHS code-565).
2. CRT-D – listed implant as per ceiling rate vide OM dated 06.08.2018 – Rs.4,90,000/- +GST. (copy enclosed)

This issue with the approval of the Competent Authority.

भवदीया/ Yours sincerely



सुसाना तिग्गा  
29/7/24  
(डॉ. सुसाना तिग्गा)/(Dr. Susana Tigga),  
अपर निदेशक (प्र. एवं अ.)/ के.स.स्वा.यो.(मु.)  
Addl. Director (R&H), CGHS (HQ)

To

The Assistant Secretary  
Ministry of Power  
Northern Regional Power Committee  
18-A, S. Jeet Singh Marg, Katwaria Sarai,  
New Delhi - 110016

PPU  
AS, NRPC

\* Please collect your original documents  
from R&H section (Room No. 105), CHS  
HQ, CHS Bhawan,

जे. रामिंदर, एए  
may be prep up  
for NRPC meeting.  
aganda.

245/c

Government of India  
Ministry of Health and Family Welfare  
Department of Health & Family Welfare  
Directorate General of CGHS  
Office of the Director, CGHS

No: S-11011/29/2018-CGHS(HEC)/ DIR/CGHS

Nirman Bhawan, New Delhi

Dated the 6<sup>th</sup> August, 2018

OFFICE MEMORANDUM

**Subject:-** Revision of ceiling rates for reimbursement of the cost of Cardiac pacemaker , AICD, Combo-device, Rotablator and Aortic Stent Graft for beneficiaries of CGHS/CS(MA) Rules

\*\*\*\*

With reference to the above subject attention is drawn to the OM No 12034/02/2014/Misc./-CGHS D.III dated 22<sup>nd</sup> July 2014 vide which ceiling rates for reimbursement of the cost of Cardiac pacemaker, AICD, Combo-device, Rotablator and Aortic Stent Graft for beneficiaries of CGHS/CS (MA) Rules were prescribed and to state that the matter has been reviewed by the Ministry and it is decided to revise the ceiling rates as per the details given under:

Sr. No.	Cardiac Device	Ceiling Rate
1	Single Chamber Cardiac Pacemaker without Rate Response	Rs. 34,840/- + GST
2	Single Chamber Cardiac Pacemaker with Rate Response	Rs. 44,928/-+ GST
3	Dual Chamber Cardiac Pacemaker	Rs.83,200/-+ GST
4	Bi-Ventricular Cardiac Pacemaker	Rs.1,95,000/-+ GST
5	Implantable Cardioverter Defibrillator (Single Chamber) (ICD/AICD-Single Chamber)	Rs.1,75,786/-+ GST
6	Implantable Cardioverter Defibrillator (Dual Chamber) (ICD/AICD-Single Chamber)	Rs. 3,75,000/-+ GST
7	Combo Device (CRT-D)	Rs. 4,90,000/-+ GST
8	Aortic Stent Graft (expandable, bifurcated and including delivery system)	Rs. 4,40,960/- + GST
9	Rotablator with Advancer	Rs.49,920/-+ GST
10	Rotablator Burr	Rs.23,920/-+ GST



Revision of ceiling rates for reimbursement of the cost of Cardia...

2. Other terms and conditions prescribed under OM No 12034/02/2014/Misc./-CGHS D.III dated 22<sup>nd</sup> July 2014 shall remain unchanged.
3. These rates shall remain valid till the rates for the above devices are notified by National Pharmaceutical Pricing Authority (NPPA).
4. Issued with the concurrence of SS&FA, Ministry of Health & Family Welfare vide CD - No.1295 dated 25.07.2018.

*Atul Prakash*  
06.08.2018  
(Dr. Atul Prakash)  
Director, CGHS

- To:
- 1 All Ministries / Departments, Government of India
  - 2 Director, CGHS, Nirman Bhawan, New Delhi
  - 3 Addl. DDG (HQ)/All Additional Directors /Joint Directors of CGHS cities outside Delhi
  - 4 All Pay & Accounts Officers under CGHS
  - 5 Additional Director (Hqrs) / Additional Director (SZ)/ (CZ)/(EZ)/(NZ), CGHS, New Delhi
  - 6 JD (Gr.)/JD(R&H), CGHS Delhi
  - 7 CGHS Desk-I/Desk-II/CGHS-I/CGHS-II, Dte.GHS, Nirman Bhawan, New Delhi
  - 8 Estt.I/ Estt.II/ Estt.III/ Estt.IV Sections, Ministry of Health & Family Welfare
  - 9 Admn.I / Admn.II Sections of Dte.GHS
  - 10 Rajya Sabha / Lok Sabha Secretariat
  - 11 Registrar, Supreme Court of India /Punjab & Haryana High Court, Chandigarh
  - 12 U.P.S.C.
  - 13 Finance Division
  - 14 Deputy Secretary (Civil Service News), Department of Personnel & Training, 5th Floor, Sardar Patel Bhawan, New Delhi.
  - 15 PPS to Secretary (H&FW)/ Secretary (AYUSH)/ Secretary (HR)/ Secretary(AIDS Control),



File No.S.14025/24/2023-EHS  
 Government of India  
 Ministry of Health & Family Welfare  
 (EHS Section)  
 .....

Nirman Bhawan, New Delhi  
 Dated 15th January, 2024

**OFFICE MEMORANDUM**

**Subject:** Enhancement in delegation of powers to HoDs in various Ministries/ Departments for settling permission cases and post facto approval relating to referral system and medical reimbursement under CS(MA) Rules, 1944.

The undersigned is directed to refer to this Ministry's OM No. S.14025/01/2014-MS dated 05.06.2014, vide which financial powers were delegated to the Heads of Departments/ Ministries to settle all such cases where there is no relaxation of rules involved and admissibility of claim was worked out with reference to the CGHS approved rates and CS(MA) guidelines.

2. This matter regarding enhancement of delegation of financial powers to the Heads of Departments/ Ministries was under consideration in this Ministry. Now, it has been decided with the approval of competent authority to enhance the existing limit of delegation from Rs. 2 Lakhs to Rs. 5 Lakhs, to settle all cases, in line with O.M. no. S.11011/20/2014-CGHS(P)/EHSS dated 23.11.2016, where there is no relaxation of rules and the entitlement was worked with reference to prescribed rate list.

3. In respect of cases involving payment exceeding Rs. 5 Lakhs but as per the prescribed rate list, the Departments/Ministries concerned may settle such cases in consultation with their respective Internal Finance Division. Only in those cases, where the settled rules/ schemes are required to be relaxed, should the case be referred to the Ministry of Health & Family Welfare.

This has the concurrence of IFD vide CD No. 2961 dated 03.01.2024.

Signed by  
 Hemlata Singh

Date: 15-01-2024 10:04:48  
 (Hemlata Singh)

Under Secretary to the Government of India  
 Tel No. 011-23061778

To

1. All Ministries/Departments, Government of India
2. DDG(M), Dte.GHS/CMO(SRA), Dte.GHS, Dte.GHS, MoHFW
3. Director, CGHS, Nirman Bhawan, New Delhi.
4. Addl.DDG(HQ), CGHS, MoHFW, Nirman Bhawan, New Delhi
5. AD(HQ), CGHS, R.K.Puram, Sector-12, New Delhi
6. All Addl. Directors/Joint Directors of CGHS cities outside Delhi
7. Additional Director (SZ)/(CZ)/(EZ)/(NZ)/(MSD), MCTC CGHS, New Delhi
8. JD(HQ), JD (Grievance)/JD (R&H), CGHS, Delhi
9. Rajya Sabha/Lok Sabha Secretariat, New Delhi

139

No. S.11011/20/2014-CGHS (P)/EHSS  
Government of India  
Ministry of Health & Family Welfare  
Department of Health & Family Welfare  
EHS Section  
\*\*\*\*\*

Ref. No. 409237/16

Nirman Bhawan, New Delhi  
Dated: the 25 November, 2016

OFFICE MEMORANDUM

**Subject:** Delegation of powers to Heads of Departments in various Ministries/Departments for settling permission cases and post facto approval relating to referral system and medical reimbursement under CGHS – Enhancement of ceiling rate from Rs. 2 Lakhs to Rs. 5 Lakhs without consultation of IFD of concerned Ministry - Reg.

The undersigned is directed to refer to this Ministry's OM No. S.12020/4/97-CGHS (P), dated 27.12.2006 and its clarification issued vide this Ministry's OM No. S.11011/20/2014-CGHS (P), dated 20.06.2014, wherein financial powers were delegated to the Heads of Departments/Ministries to settle all such cases where there is no relaxation of rules involved and admissibility of claim was worked out with reference to the CGHS approved rate list and guidelines.

2. This Ministry has been receiving requests from different Ministries/Departments for enhancement of delegation of financial powers to Head of Departments to settle medical claims/medical advance cases involving financial implications upto Rs. 5 Lakhs without referring the case to Internal Finance Division (IFD).

3. The matter regarding enhancement of delegation of financial powers to the Heads of Departments/Ministries has been examined in this Ministry and it has been decided with the approval of the competent authority to enhance the existing limit of Rs. 2 Lakhs to Rs. 5 Lakhs to settle all cases where there is no relaxation of rules and the entitlement was worked out with reference to the rate list prescribed.

In respect of cases involving payment exceeding Rs. 5,00,000/- (Rupees 5 Lakhs only) but as per the prescribed rate list, the concerned Departments/Ministries may settle such cases in consultation with their respective Internal Finance Division. Only in those cases where the settled scheme/rules are required to be relaxed, should the case be referred to the Ministry of Health and Family Welfare.

4. This issue with concurrence of Internal Finance Division vide FTS No. 91725, dated 01.11.2016.

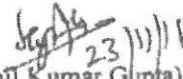
  
(Sunil Kumar Gupta)  
Under Secretary to the Govt. of India  
(Tel 2306 1986)

To

- 1) All Ministries/Departments, Government of India
- 2) Director, CGHS, Nirman Bhawan, New Delhi
- 3) Addl.DDG(HQ), CGHS, MoHFW, Nirman Bhawan, New Delhi

 Contd....2/-



भारत सरकार / Government of India  
विद्युत मंत्रालय / Ministry of Power  
केन्द्रीय विद्युत प्राधिकरण / Central Electricity Authority  
Sewa Bhavan, R.K.Puram, New Delhi-110066

\*\*\*\*\*

## Budget Section

\*\*\*\*\*

No. 1/1/2023-Bud(CEA)//302-1308

Date: 01/05/2023

To

The Member Secretary, North Eastern Regional Power Committee, NERPC Complex Dong Parmaw Lapalangi, Shillong 793009.	The Member Secretary, Western Regional Power Committee, F-3, MIDC Area, Marol, Opp. SEEPZ, Central Road, Andheri (East), Mumbai 400093
The Member Secretary, Southern Regional Power Committee Central Electricity Authority 29 Race Course Cross Road, Bangalore-560009	The Member Secretary, Eastern Regional Power Committee 14, Golf Club Road, Tollygunj, Kolkata-700033
The Member Secretary, Northern Regional Power Committee, 18A, Qutab Institutional Area, Shaheed Jeet Singh Marg, Katwaria Sarai, New Delhi 110016	

**Subject: - Implementation of the recommendation of streamlining the process of fund utilization/budgetary provisions of all RPCs – Minutes of meeting chaired by Chairperson, CEA on 06.04.2023 -reg.**

Sir,

The undersigned is directed to enclose herewith a copy of Standard Operating Procedure (SoP) and Minutes of the Meeting held under the Chairmanship of Chairperson, CEA on 06.04.2023 to streamlining the process of fund utilization/budgetary provisions of all RPCs, for your kind information and further necessary action.

This issues with the approval of Chairperson, CEA.

Encl.: as above.

Yours faithfully,

*V. Karthik*  
1/5/23  
(Vagicharla Karthik)  
Deputy Director (B&A)

Copy for information to: -

1. PPS to Chairperson, CEA.
2. PS to Secretary, CEA.

वागिचर्ला कार्तिक / Vagicharla Karthik  
उप निदेशक / Deputy Director  
केन्द्रीय विद्युत प्राधिकरण / C.E.A.  
विद्युत मंत्रालय / Ministry of Power  
भारत सरकार / Govt. of India  
नई दिल्ली / New Delhi-66



भारत सरकार  
Government of India  
विद्युत मंत्रालय  
Ministry of Power  
उत्तर क्षेत्रीय विद्युत समिति  
Northern Regional Power Committee

सं. उक्षेविस/प्रशासन/509/2023/4379 - 4386

दिनांक: 24<sup>th</sup> April, 2023

**Sub: Minutes of the meeting taken by Chairperson, CEA for streamlining the process of fund utilization/ budgetary provisions of all RPCs-reg**

A meeting was taken by Chairperson, CEA for streamlining the process of fund utilization/ budgetary provisions of all RPCs on 06.04.2023 (10:30 AM) via video-conferencing. Minutes of the same may be found attached.  
This issues with approval of Chairperson, CEA.

(Reeturaj Pandey)  
Assistant Secretary &  
HoO

सेवा में,

1. Member Secretary, WRPC, Mumbai-400093.
2. Member Secretary, SRPC, Bangalore-560009
3. Member Secretary, ERPC, Kolkata-700033.
4. Member Secretary, NERPC, Shillong-793003.
5. Director (B&A), CEA, New Delhi - 110066

Copy for information to: -

1. Chairperson, CEA, Sewa Bhawan, R. K. Puram sector – 1. New Delhi - 66
2. Secretary, CEA, Sewa Bhawan, R. K. Puram sector – 1. New Delhi – 66
3. Member Secretary, NRPC, Katwaria Sarai, New Delhi-16



**Minutes of the meeting taken by Chairperson, CEA on 06.04.2023 for streamlining the process of fund utilization/ budgetary provisions of all RPCs**

MS, NRPC welcomed Chairperson, CEA, Member Secretaries of RPCs, and Director (B&A), CEA.

List of participants in the meeting is attached as **Annexure-I**.

1. MS, NRPC apprised that Central Electricity Authority (CEA) vide its order no. 17-11/16/2022-Budget/CEA/02-07 dtd. 02.01.2023 constituted the committee consisting of the following officers for streamlining the process of fund utilization/ budgetary provisions of all RPCs:
  - i. Member Secretary, NRPC, *Chairman*
  - ii. Member Secretary, WRPC, *Member*
  - iii. Member Secretary, ERPC, *Member*
  - iv. Member Secretary, SRPC, *Member*
  - v. Member Secretary, NERPC, *Member*
  - vi. Director/DS (B&A), CEA, *Member & Convenor*
2. Committee had meeting on 23.01.2023 under chairmanship of Member Secretary, NRPC. The meeting was attended by all committee members. Recommendation of committee are:
  - i. RPCs budget head of Salary, Leave Encashment, Allowances, LTC, Medical, DTE, and FTE may be taken from CEA as it is done currently. However, expenditure under other heads which do not impact employees salary and allowances directly such as office expenses, procurement, civil and electric works, training, workshop, meetings etc. may be done from RPC Fund.
  - ii. RPCs may formulate PSM (Payment Security Mechanism) by making Late Payment Surcharge (LPS) Rules.
  - iii. RPCs may formulate SOP (Standard Operating Procedure) for expenses to be done from RPCs fund and its audit.
  - iv. NERPC may take up the matter regarding funding of office expenses of NERPC in their board meeting for reconsideration by the constituents.
3. He apprised that draft Report of committee and draft SoP was prepared by NRPC Sectt. and it was circulated to all members of the committee vide mail dtd. 11.02.2023 for comments. Comments received from SRPC, ERPC, and NERPC. No comments received from WRPC, and Director (B&A), CEA.
4. Based on comments received, Report and SOP has been prepared and proposed for approval.
5. MS, NRPC presented SOP in detail.
6. MS, ERPC stated that it shall be made mandatory to take approval of CEA/MoP for capital expenditure. Chairperson, CEA stated that all capital expenditure shall not require approval but expenditure like construction of new building may be done after prior approval of CEA/MoP.
7. MS, NERPC raised concern that their constituents are not contributing for RPC Fund. They contribute only for expenditure of meetings. Chairperson, CEA suggested that

he may take up the matter in their next NERPC meeting for collection of contribution amount.

8. After deliberation, following was decided to be included in SOP:
- i. All expenditure of 'Salary' head shall be met by fund provided by CEA. The same shall be reimbursed by RPCs to CEA quarterly as per existing practice.
  - ii. All expenditure of heads other than 'Salary', shall be met by RPC Fund.
  - iii. RPCs shall have an standing quarterly agenda in RPC meeting regarding intimation/approval of expenditure from RPC Fund.
  - iv. CEA shall be IFD for only those budget heads (Salary) which has been allocated by CEA. For all other expenditure, approvals shall be taken in RPC meeting.
  - v. Procurement from RPC Fund shall be done from GeM portal only. Any relaxation of GeM portal may be permissible in accordance with government order/rules only.
  - vi. Internal audit shall be done by Director level official(s) (not dealing administration matters) of same RPC.
  - vii. External audit shall be done by a CA firm.
  - viii. All type of new construction/project, intended for long duration (such as construction of new building), shall be done after approval of CEA/MoP. For all kind of maintenance work, it shall be done with the approval of MS of respective RPC.
9. Final SOP after above inclusion is attached as **Annexure-II**.

Meeting ended with vote of thanks to the Chair.

\*\*\*\*\*

**CEA**

1. Sh. Ghanshyam Prasad, Chairperson, CEA
2. Sh. Anand Upadhyay, Director (B&A), CEA

**NRPC**

1. Sh. Naresh Bhandari, Member Secretary, NRPC
2. Sh. Reeturaj Pandey, Assistant Secretary, NRPC

**WRPC**

1. Sh. Satya Narayan, Member Secretary, WRPC

**SRPC**

1. Sh. Asit Singh, Member Secretary, SRPC

**ERPC**

1. Sh. N. S. Mondal, Member Secretary, ERPC

**NERPC**

1. Sh. Kishore Jagtap, Member Secretary, NERPC

**Standard Operating Procedure (SOP)**  
**For budgeting and expenditure of RPCs**

**1. Budget of RPCs:**

- 1.1 RPCs shall decide and collect contribution amount from their member organizations after approval in committee meeting.
- 1.2 RPCs shall finalize its annual internal Budget (except Salary head) and get its approval in committee meeting. Quarterly expenditure from 'RPCs internal budget' shall be put up for intimation/approval in concerned RPCs meeting.
- 1.3 CEA shall provide budget to RPCs for 'Salary' head only.

**2. Expenditure of RPCs:**

- 2.1 All expenditure of 'Salary' head shall be met by budget provided by CEA. The same shall be reimbursed by RPCs to CEA quarterly in line with MoP letter no. 6/10/90-Trans dtd. 03.04.2006 (**Annexure-1**).
- 2.2 All expenditure of heads other than 'Salary', shall be met by concerned RPCs Fund.

**3. Delegation of Financial Power:**

- 3.1 Member Secretary, RPC shall have following financial powers for expenditure:

Recurring Expenditure	Upto 10 Lakh (per case)
Non-Recurring Expenditure	Upto 25 Lakh (per case)

- 3.2 For amount more than mentioned above, Member Secretary may incur after prior discussion and approval in respective RPCs meeting.
- 3.3 All type of new construction/project, intended for long duration (such as construction of new building) shall be done after approval of CEA/MoP. For all kind of maintenance work, it shall be done with the approval of MS of respective RPC.



**4. IFD for expenditure:**

4.1 CEA shall be IFD for only those budget heads (Salary) which has been allocated by CEA. For all other expenditure, approvals shall be taken in RPC meeting only.

**5. Compliance of government rules:**

5.1 Any expenditure from RPCs fund shall be done as per GFR and other applicable rules, guidelines and manuals of Central Government.

**6. Mode and payment of procurement:**

6.1 Procurement from RPC Fund shall be done from GeM portal only. Any relaxation of GeM portal may be permissible in accordance with government order/rules only.

**7. Creation of Other Specific Funds:**

7.1 The RPCs may create any other Fund for any specific purpose with approval of RPC committee.

**8. Procedure for audit:**

8.1 Internal audit shall be done by Director level official(s) (not dealing administration matters) of same RPC.

8.2 External audit shall be done from a CA Firm.

**9. Amendment in SOP:**

9.1 Amendment in SOP may be proposed after joint discussion by all Member Secretaries of RPCs for approval of Chairperson, CEA.

\*\*\*\*\*

F.No.6/10/90-Trans  
Government of India  
Ministry of Power  
\*\*\*

True Copy

New Delhi the 3<sup>rd</sup> April, 2006

To  
The Chairperson  
Central Electricity Authority,  
Sewa Bhawan, R.K.Puram,  
New Delhi.

Subject: Reimbursement of expenditure incurred by the Regional Power Committees by their constituents.

Sir,  
I am directed to refer to this Ministry's letter of even number dated the 20<sup>th</sup> March, 2006 and to say that the following may be added at the end of the second paragraph of the said letter:

" For a transition period of six months the establishment expenditure of RPC would be met out of the budget of the CEA and the same will be reimbursed by the constituent members of the RPCs. Meanwhile, the constituents of RPCs will finalise the share of expenditure to be borne by the constituents of RPCs so that the RPCs become self-financing. The expenditure meted out from the budget and contribution of share by the constituent members will be reviewed by the Ministry of Power, every quarter".

2. This issues with the approval of the Internal Finance Vide their Dy. No. 486/DS (F) dated 3.4.2006.

Yours faithfully,  
Sd/-

(K.V.Gopala Rao)

Under Secretary to the Government of India  
Tel No. 2371-9710

Copy to:

1. Pay & Accounts Officer, Ministry of Power, New Delhi
2. Controller of Accounts, Ministry of Power, New Delhi
3. Member (G & O), Central Electricity Authority, New Delhi
4. Member Secretaries, All RPCs.

Copy also to:

PPS to Secretary (P) / PS to AS (P)/JS (A)/JS (Trans)/ JS (FA)/DS (A). Ministry of Power/US (Budget).

NRPC Members for FY 2024-25			
S. No.	NRPC Member	Category	Remarks
1	Member (GO&D), CEA	Member (Grid Operation & Distribution), Central Electricity Authority (CEA)	-
2	Member (PS), CEA	Nodal Agency appointed by the Government of India for coordinating cross-border power transactions	-
3	CTUIL	Central Transmission Utility	-
4	PGCIL	Central Government owned Transmission Company	-
5	NLDC	National Load Despatch Centre	-
6	NRLDC	Northern Regional Load Despatch Centre	-
7	NTPC	Central Generating Company	-
8	BBMB		-
9	THDC		-
10	SJVN		-
11	NHPC		-
12	NPCCIL		-
13	Delhi SLDC	State Load Despatch Centre	-
14	Haryana SLDC		-
15	Rajasthan SLDC		-
16	Uttar Pradesh SLDC		-
17	Uttarakhand SLDC		-
18	Punjab SLDC		-
19	Himachal Pradesh SLDC	State Transmission Utility	-
20	DTL		-
21	HVPLN		-
22	RRVPLN		-
23	UPPTCL		-
24	PTCUL		-
25	PSTCL	State Generating Company	-
26	HPPTCL		-
27	IPGCL		-
28	HPGCL		-
29	RRVUNL		-
30	UPRVUNL		-
31	UJVNL	State Generating Company & State owned Distribution Company	-
32	HPPCL		-
33	PSPCL	State owned Distribution Company (alphabetical rotational basis/nominated by state govt.)	-
34	UHBVN		There are only 2 STATE DISCOMs DHBVN & UHBVN
35	Jodhpur Vidyut Vitran Nigam Ltd.		Jodhpur Vidyut Vitran Nigam Ltd. Comes after Jaipur Vidyut Vitran Nigam Ltd. as per alphabetic rotation. There are 3 state DISCOMs Ajmer, Jaipur & Jodhpur.
36	Paschimanchal Vidyut Vitaran Nigam Ltd.		Paschimanchal Vidyut Vitaran Nigam Ltd. comes after MVVNL as per alphabetical rotation. There are 4 state DISCOMs: Dakshinanchal, Madhyanchal, Paschimanchal, Purvanchal.
37	UPCL	UPCL is sole state DISCOM	-
38	HPSEB		HPSEB is sole state DISCOM
39	Prayagraj Power Generation Co. Ltd.	IPP having more than 1000 MW installed capacity	-
40	Aravali Power Company Pvt. Ltd		-
41	Apraava Energy Private Limited		-
42	Talwandi Sabo Power Ltd.		-
43	Nabha Power Limited		-
44	Lanco Anpara Power Ltd		-
45	Rosa Power Supply Company Ltd		-
46	Lalitpur Power Generation Company Ltd		-
47	MEJA Urja Nigam Ltd.		-
48	Adani Power Rajasthan Limited		-
49	JSW Energy Ltd. (KWHEP)	-	
50	TATA POWER RENEWABLE	IPP having less than 1000 MW installed capacity (alphabetical rotational basis)	TATA POWER RENEWABLE comes after RENEW
51	UT of J&K	From each of the Union Territories in the region, a representative nominated by the administration of the Union Territory concerned out of the entities engaged in generation/ transmission/ distribution of electricity in the Union Territory.	JKPCL has been considered.
52	UT of Ladakh		LPPD has been considered.
53	UT of Chandigarh		Electricity Wing of Engineering Department, Chandigarh Administration
54	NPCL	Private Distribution Company in region (alphabetical rotational basis)	NPCL comes after BYPL. There are 4 private DISCOMs in NR i.e. BRPL, BYPL, NPCL and TPDDL.
55	Fatehgarh Bhadla Transmission Limited	Private transmission licensee (nominated by central govt.)	As nominated by CEA on alphabetical rotational basis.
56	NTPC Vidyut Vyapar Nigam Ltd.	Electricity Trader (nominated by central govt.)	As nominated by CEA.



**NORTHERN REGIONAL POWER COMMITTEE**  
**KATWARIA SARAI, NEW DELHI**

**CONDUCT OF BUSINESS**  
**Rules, 2024**

**August 2024**

# Contents

CHAPTER-I: GENERAL.....	1
1. Short title and commencement .....	1
2. Definitions .....	1
3. Functions of NRPC .....	2
4. Secretariat of NRPC .....	3
5. Furnishing of data / information to Secretariat of RPC.....	5
6. Chairperson of NRPC .....	5
7. Website of NRPC.....	5
CHAPTER-II: PROCEDURE FOR CONDUCTING NRPC MEETINGS.....	6
8. Place and date of NRPC Meeting.....	6
9. Periodicity of meetings.....	6
10. Notice for the Committee meetings and Agenda .....	6
11. Effect of Non-receipt of Notice of Meeting by a Member .....	6
12. Cancellation / re-scheduling of Meeting .....	7
13. Quorum of NRPC Meeting.....	7
14. Presiding Authority.....	7
15. Recording of the minutes .....	7
16. Confirmation of the Minutes.....	7
CHAPTER-III: SUB-COMMITTEES OF NRPC.....	8
17. Constitution of Sub-Committees of NRPC.....	8
18. Technical Co-Ordination Sub-Committee (TCC) .....	8
19. Operation Co-Ordination Sub-Committee (OCC) .....	9
20. Commercial Sub-Committee (CSC):.....	10
21. Protection Sub-Committee (PSC) .....	10
22. System Study Sub-Committee (SSC):.....	11
23. LGBR Sub-Committee .....	12
24. Telecommunication, Scada & Telemetry (TeST) Sub-Committee .....	12
25. Renewable Energy Sub-Committee (REC) .....	13
CHAPTER-IV: PROCEDURE FOR CONDUCTING SUB-COMMITTEE MEETINGS OF NRPC .....	14
26. Conducting of Sub-Committee Meetings, issue of Notice, Agenda & its Minutes.....	14
CHAPTER-V: Operation of “NRPC-Fund” .....	15
27. NAME:.....	15

28.	PURPOSE:.....	15
29.	CONTRIBUTION:.....	15
30.	OPERATION:.....	15
31.	MAINTENANCE OF ACCOUNTS:.....	16
32.	VERIFICATION OF ACCOUNTS:.....	16
CHAPTER-VI: REPORTS.....		17
33.	REPORTS BY NRPC .....	17
CHAPTER-VII: MISCELLANEOUS.....		18
34.	Saving of inherent Power of the NRPC.....	18

## CHAPTER-I: GENERAL

### 1. Short title and commencement

- 1.1 Government of India, under the provision of Section 2, Subsection 55 of the Electricity Act 2003 vide resolution F.No. 23/21/2021-R&R dated 3<sup>rd</sup> December 2021 (copy enclosed) published in the Gazette of India has established the Northern Regional Power Committee herein after referred to as NRPC comprising of states of Delhi, Haryana, Himachal Pradesh, Punjab, Rajasthan, Uttaranchal and Uttar Pradesh and the Union Territories of Chandigarh, Jammu & Kashmir and Ladakh.
- 1.2 As per the clause-9 of the aforesaid resolution dated 3<sup>rd</sup> December 2021, the NRPC hereby makes the following rules which may be called "The Northern Regional Power Committee (Conduct of Business) Rules, 2024".
- 1.3 These rules shall come into force from the date of its approval by the NRPC and shall remain in force unless otherwise modified.

### 2. Definitions

- 2.1. In these Rules unless the context otherwise requires:

- (a) 'Act' means the Electricity Act, 2003.
- (b) 'Agenda' means the list of business proposed to be transacted at a meeting of the Committee or Sub-Committee.
- (c) 'Authority' means Central Electricity Authority.
- (d) 'Commercial Sub-Committee (CSC)' means a sub-committee constituted by the Committee to consider commercial related issues.
- (e) 'Commission' means Central Electricity Regulatory Commission.
- (f) 'Committee' means the Northern Regional Power Committee constituted by the Central Government under Sub-Section (55) of Section 2 of the Electricity Act, 2003.
- (g) 'Government Resolution' means resolution No. 23/21/2021-R&R dated 3<sup>rd</sup> December 2021, notified by Government of India and amendment(s) thereon.
- (h) 'IEGC' means the Indian Electricity Grid Code, specified by Central Electricity Regulatory Commission.
- (i) LGBR Sub-Committee means a sub-committee constituted by the committee to -
  - i. finalise annual outage plan of generating stations
  - ii. prepare anticipated power supply position for next fiscal and
  - iii. for periodic review of (i) & (ii).

- (j) 'Meeting' means a meeting of the committee / sub-committee convened by the Member Secretary, NRPC Secretariat or any member authorized to convene a meeting in the absence of the head of Secretariat.
- (k) 'Member' means the member of the as per Resolution of the Government of India on establishment of NRPC dated 3<sup>rd</sup> December 2021 and as amended from time to time.
- (l) 'NLDC' means National Load Despatch Centre.
- (m) 'NRLDC' means Northern Regional Load Despatch Centre
- (n) 'Operational Coordination Sub-Committee (OCC)' means a sub-committee constituted by the NRPC to consider all issues related to operation of the regional grid.
- (o) 'Protection Sub-Committee (PSC)' means a sub-committee constituted by the Committee to consider all power system protection related issues.
- (p) 'Renewable Energy Sub-Committee (REC)' means a sub-committee constituted by the Committee to consider all Renewable Energy related issues.
- (q) 'Rule' means Northern Regional Power Committee (Conduct of Business) Rules as amended.
- (r) 'SLDC' means State Load Despatch Centre.
- (s) 'Sub-Committee' means the Sub-Committees constituted by NRPC to guide and assist it in conducting the functions assigned to it.
- (t) 'System study Sub-Committee' means a sub-committee constituted by NRPC to carry out the Power System studies.
- (u) 'Technical Coordination Sub-Committee (TCC)' means a sub-committee constituted by the NRPC to assist the NRPC on all technical, commercial and other matters.
- (v) 'TeST Sub-Committee' means a sub-committee constituted by the NRPC to assist the NRPC on all Telecommunication, SCADA & Telemetry related issues.
- (w) 'Year' means Financial Year.

2.2. The words and expressions used and not defined in these Rules shall be construed as having the same meaning as defined in the Act.

2.3. Reference to any Acts, Rules and Regulations shall include amendments or consolidation or re-enactment thereof.

### **3. Functions of NRPC**

3.1. The committee shall carry out following functions:

3.1.1 To undertake Regional Level operation analysis for improving grid performance.



- 3.1.2 To facilitate inter-state/inter-regional transfer of power.
- 3.1.3 To facilitate all functions of planning relating to inter-state/ intra-state transmission system with CTU/STU.
- 3.1.4 To provide views on the inter-state transmission system planned by CTU within 45 days of receipt of the proposal by the concerned NRPC. The views of NRPC will be considered by National Committee on Transmission for sending their recommendation to Ministry of Power for approval of new inter-state transmission system.
- 3.1.5 To coordinate planning & maintenance of generating machines of various generating companies of the region including those of inter-state generating companies supplying electricity to the Region on an annual basis and also to undertake review of maintenance programme on a monthly basis.
- 3.1.6 To undertake planning of outage of transmission system on a monthly basis.
- 3.1.7 To undertake operational planning studies including protection studies for stable operation of the grid.
- 3.1.8 To undertake planning for maintaining proper voltages through review of reactive compensation requirement through system study committee and monitoring of installed capacitors.
- 3.1.9 To evolve consensus on all issues relating to economy and efficiency in the operation of power system in the region.

#### **4. Secretariat of NRPC**

- 4.1. Secretariat, NRPC shall perform the following duties namely;
  - 4.1.1. Keep custody of records of proceedings of the Committee, sub-committees, task force and working groups of the NRPC.
  - 4.1.2. Prepare agenda for the Committee and Sub-Committee meetings.
  - 4.1.3. Prepare minutes of Committee and Sub-Committee meetings.
  - 4.1.4. Take follow-up action on the decision taken in the Committee & Sub-Committee meetings.
  - 4.1.5. Maintain archive of data and information pertaining to commercial accounts, operating parameters, protection system and communication system of the regional power system.
  - 4.1.6. Collect from constituent members or other offices, companies, firms or any other party as may be considered useful for the efficient discharge of functions of NRPC under the Resolution and place the information before the Committee and its sub-committees.
  - 4.1.7. Certification of open cycle generation carried out by central sector gas-based stations.

- 4.2. The duties and responsibility envisaged under Indian Electricity Grid Code (IEGC) Regulations made by CERC, NRPC Resolution and NRPC from time to time shall be carried out by the NRPC Secretariat.
- 4.3. In line with the provisions of IEGC the details of functions are given below:
- 4.3.1. The Member Secretary, NRPC shall investigate and endeavour to resolve the grievance regarding unfair practices, delays, discrimination, lack of information, supply of wrong information or any other matter related to open access in inter-state transmission system.
  - 4.3.2. The Member Secretary, NRPC shall, for the purpose of payment of transmission charges/ capacity charges and incentives, certify:
    - (i) Availability of Regional AC system and outage hours of HVDC transmission system.
    - (ii) Availability and Plant Load Factor for ISGS.
  - 4.3.3. Member Secretary, NRPC, shall verify and take up the matter regarding persistent non-compliance of IEGC with the defaulting agency for expeditious termination of the non-compliance. NRPC Secretariat shall maintain appropriate records of such violation.
  - 4.3.4. NRPC Secretariat is to carry out periodic inspection of Under Frequency Relays installed by the constituents and investigate cases of non-operation of such relays at set frequency in actual system operation.
  - 4.3.5. The NRPC Secretariat shall review on monthly basis the Annual outage plan prepared by CEA in consultation with all parties concerned.
  - 4.3.6. The NRPC Secretariat shall be responsible for analyzing the outage schedule given by all Regional Constituents, preparing a draft annual outage schedule and finalization of the annual outage plan for the following financial year by 31<sup>st</sup> December of each year.
  - 4.3.7. Any other responsibilities assigned by CERC/ CEA Regulations/ NRPC Resolution shall also be carried out by secretariat.

#### **4.4. Human Resources**

- 4.4.1. Officers and staff to man the Secretariat shall be provided by CEA. As and when CEA is unable to provide requisite number of Group "C" or "D" officials, the vacant posts shall be got outsourced through competitive bidding route for a period up to two (2) years or until CEA provides the manpower. Their remuneration shall be within the ambit of "Minimum Wages Act, 1948".
- 4.4.2. Member Secretary is also empowered to appoint personnel in case of shortage of staff at other levels on secondment basis.
- 4.4.3. For discharging the functions other than those assigned by the Resolution, NRPC may hire adequate number of persons, experts or consultants.

- 4.4.4. For the purpose of handling NRPC fund, Member Secretary shall appoint one nodal officer from the constituents of NRPC on secondment basis. In the absence of nodal officer from NRPC constituent, MS, NRPC can temporarily appoint one officer of NRPC Secretariat to handle NRPC fund.

#### **4.5. Contribution towards NRPC Fund**

- 4.5.1. An NRPC fund shall be maintained from contributions from members of NRPC for a particular year. A nodal officer shall be appointed as per clause 4.4.4. for the purpose of handling this fund.
- 4.5.2. The constituents shall deposit their contributions towards NRPC fund, based on the figures approved in the first NRPC meeting held in that financial year. The fund shall be utilized for reimbursement of budgetary allocation from Government of India, expenditure for conducting various meetings/training programs, expenditure for maintenance of NRPC Secretariat, hiring of additional staff/consultants, or any other expenditure as approved by the NRPC forum. Any surplus/ deficits of a particular year shall be adjusted in the subsequent financial year.
- 4.5.3. All the member constituents of NRPC except CEA, NLDC, NRLDC and CTU shall equally share the expenditure of NRPC Secretariat.
- 4.5.4. Audit shall be done as per SOP issued by Central Electricity Authority and reports for the same shall be placed before NRPC forum.

#### **5. Furnishing of data / information to Secretariat of RPC**

- 5.1. NRLDC and the constituents of the region shall make available all data / information required by the Secretariat to discharge its functions or to carry out any other responsibility / function assigned to it by the Authority / Commission / Committee. It shall also be responsibility of the constituents to ensure that any data though not specifically asked for by the Secretariat, but which may be required for the specific responsibility / function assigned to the Secretariat is also made available to the secretariat.
- 5.2. NRLDC shall provide to Member Secretary, NRPC a computer terminal to have a view of all the parameters in real time frame of Northern Regional grid system.

#### **6. Chairperson of NRPC**

The Chairperson of NRPC would be appointed as per 'Government Resolution'.

#### **7. Website of NRPC**

The NRPC shall have its own website which shall be maintained by NRPC Secretariat.

## **CHAPTER-II: PROCEDURE FOR CONDUCTING NRPC MEETINGS**

### **8. Place and date of NRPC Meeting**

- 8.1. The place and date of the meeting will be decided by Member Secretary, NRPC in consultation with Chairperson, NRPC. The meeting will generally be held within the region.
- 8.2. Meeting will be hosted by the member organizations as per the roster prepared by Member Secretary, NRPC in consultation with the members of the NRPC.
- 8.3. In case the situations are not conducive for physical meetings, the meetings will be conducted through Video Conferencing.

### **9. Periodicity of meetings**

- 9.1. The Committee members shall **meet at least once in a month**, as per para-11 of "Resolution". However, the Committee may meet to discuss any issue as and when required in consultation with Chairperson, RPC.

### **10. Notice for the Committee meetings and Agenda**

- 10.1. Notice for the Committee meetings shall be issued by Member Secretary, NRPC at least 3 weeks in advance in consultation with Chairperson, NRPC. In case of exigency or meeting through video conferencing, meetings required to be conducted to carry out urgent business, notice of one week is to be given.
- 10.2. The agenda points for the meeting shall be sent to the Member Secretary by the members at least 2 weeks in advance of the meeting. The member Secretary, NRPC shall finalize the agenda and circulate the same to all its members at least 1 week in advance and also be posted on the website.
- 10.3. Normally, NRPC shall meet to discuss the agenda related to transmission planning submitted by CTU on monthly basis. Discussions other than those related to transmission planning shall generally be put up after discussions in Technical Co-ordination Sub-Committee (TCC) which will be held as and when required.
- 10.4. Member Secretary, NRPC may also put any agenda involving urgent matters / policy issue directly before NRPC in consultation with Chairperson, NRPC.
- 10.5. Member Secretary, NRPC may convene a meeting on short notice on any urgent matter in consultation with Chairperson of the committee.
- 10.6. On receipt of specific request from a member too, Member Secretary, NRPC may convene a meeting in accordance with clause 10.5 above.

### **11. Effect of Non-receipt of Notice of Meeting by a Member**

- 11.1. The non-receipt of notice by any member of NRPC or sub-committee shall not invalidate the proceeding of the meeting or any decision taken in the meeting.

## **12. Cancellation / re-scheduling of Meeting**

- 12.1. If a meeting is required to be cancelled or rescheduled the same shall be intimated to the members at the earliest by e-mail and also posted in NRPC website immediately.

## **13. Quorum of NRPC Meeting**

- 13.1. The Quorum of the meeting shall be at least 50% of its members.
- 13.2. All decision in the NRPC shall be taken by consensus.
- 13.3. The decisions / ratifications made by the Committee during the meeting with the above quorum shall be treated as final.
- 13.4. The decision of the NRPC arrived at for Operation of the Regional Grid and Scheduling and dispatch of electricity shall be followed by Northern Regional Load Despatch Centre (NRLDC) subject to the directions or regulations of the Commission.
- 13.5. Only members of NRPC and not more than two representatives of his organization shall participate in the Committee meeting. Other persons may attend the meeting by invitation / permission only. However, voting rights will be available only to the Members of NRPC.

## **14. Presiding Authority**

- 14.1. The Chairperson, NRPC shall preside over the meeting of NRPC and conduct business. The Member Secretary, NRPC shall assist the Chairperson of NRPC in conducting the meeting. If the Chairperson is unable to be present at the meeting for any reason, the senior member of NRPC from the State utilities present in the meeting shall be requested by Member Secretary to preside over the meeting.
- 14.2. In the absence of Member Secretary, NRPC the next senior most officer of the NRPC Secretariat shall convene the meeting.

## **15. Recording of the minutes**

- 15.1 The minutes of the meeting shall be finalized and circulated to all its members by the Members Secretary, NRPC within 15 working days from the date of the Committee Meeting. The minutes shall also be posted on the website of NRPC.
- 15.2 The discussions during the meeting shall be Audio recorded and the record shall be kept at the secretariat of NRPC till the confirmation of the minutes. The member organization hosting the meeting shall extend all facilities for audio recording of the proceedings of the meeting.

## **16. Confirmation of the Minutes**

- 16.1 Minutes of the NRPC meeting shall be placed in the next meeting for confirmation. However, in case of urgency the minutes may be confirmed by circulation.

## **CHAPTER-III: SUB-COMMITTEES OF NRPC**

### **17. Constitution of Sub-Committees of NRPC**

17.1. Following Sub-Committees will be constituted by NRPC to guide and assist it in conducting the functions assigned to it:

- (a) Technical Co-Ordination Sub-Committee (TCC)
- (b) Operation Co-Ordination Sub-Committee (OCC)
- (c) Commercial Sub-Committee (CSC)
- (d) Protection Sub-Committee (PSC)
- (e) System Study Sub-Committee (SSC)
- (f) LGBR Sub-Committee
- (g) Telecommunication, SCADA & Telemetry (TeST) Sub-Committee
- (h) Renewable Energy Sub-Committee (REC)

17.2. NRPC or Member Secretary, NRPC or any Sub-Committee may constitute task force, core group for specific purpose from among the members and external experts to advice on any specific issue.

### **18. Technical Co-Ordination Sub-Committee (TCC)**

#### **18.1. Functions:**

18.1.1. Technical Co-ordination Sub-Committee, shall consider all issues referred by the Operation Co-Ordination Sub-Committee, Commercial Sub-Committee, Protection Sub-Committee, System Study Sub-Committee, LGBR Sub-Committee and TeST Sub-Committee concerning operation of regional grid, commercial aspects, inter-state/ inter-regional transfer of power, grid stability etc. leading to economy and efficiency in the operation of power system in the region.

18.1.2. TCC shall implement the decisions of the NRPC and also provide guidance and assist NRPC in discharge of its functions and formulation of policy matters on regional grid operation, grid security, and commercial matters.

#### **18.2. Composition of Technical Co-ordination Sub-Committee:**

18.2.1. TCC shall be represented by the Technical Members of the NRPC constituents dealing with the Generation / transmission / Distribution and representative from Central Electricity Authority. The representation shall be at the level of Technical Heads in State Utilities, Executive Directors / Chief General Managers or equivalent in PSUs / Technical Heads of Distribution company / Traders / IPPs and Chief Engineer in CEA.

18.2.2. Chairperson, NRPC from their concerned State shall appoint the Chairperson of TCC. Chairperson, TCC shall be rotated every year from among the States in the same order as Chairperson of NRPC.

**18.3. Meetings:**

18.3.1. TCC shall meet as and when required, and put up its recommendations to the NRPC.

18.3.2. TCC shall meet separately also as and when needed to address urgent issues or specific issues, if any, concerning the operation of regional grid, security of the grid, commercial matters and other issues.

18.3.3. The Chairperson of the TCC shall preside over the meeting. In case Chairperson is unable to be present, Member Secretary, NRPC shall request a person among TCC members to preside over the meeting.

18.3.4. Member Secretary, NRPC shall assist Chairperson, TCC in conducting TCC Meeting.

**19. Operation Co-Ordination Sub-Committee (OCC)**

**19.1. Functions:**

Operation Co-ordination Committee(OCC) shall discuss all issues related to operation of the regional grid viz. estimating availability of power and energy from each power station and demand of each State for the current and next month; drawing up coordinated maintenance schedule for generating units and major transmission lines; reviewing operational discipline and its norms to be observed by constituents; reviewing the operation of Automatic Under-Frequency Relays; discussing system occurrences, if any, during the previous month and reviewing the status of implementation of the recommendations of the Inquiry Committees; monitoring / reviewing violation of provisions of IEGC related to grid operation; discussing / reviewing measures for ensuring economic grid operation including optimisation of energy transfer with other regions; examining possibility of optimising intra-regional energy exchanges; discussing optimisation of energy transfer with other regions; and any other matter referred by the TCC/NRPC.

**19.2. Composition of Operation Co-Ordination Committee:**

19.2.1. OCC shall be represented by the representatives of the constituent members of NRPC. The nominated representative shall be at the level of Chief Engineers in State Utilities/ General Manager in CPSEs or equivalent level conversant with operational issues.

19.2.2. Member Secretary, NRPC shall be Chairperson of the OCC and preside over the meetings. Superintending Engineer of secretariat shall be convener of the OCC.

**19.3. Meetings:**

The meeting will be held every month generally before 20<sup>th</sup> day of that month.

## **20. Commercial Sub-Committee (CSC):**

### **20.1. Functions:**

Commercial Sub-Committee(CSC) shall discuss all commercial related issues viz. energy accounting, schemes required for inclusion in the Bulk Power Supply Agreements, requirement of power from the new projects, installation of special energy meters and its cost sharing, etc., metering aspects, reviewing of the payments towards Regulatory accounts, issues related to transmission charges, commercial issues in inter-state and inter-regional exchange of power, issues concerning settlement of payments among constituents, if any, etc. and any other matter referred by the TCC/NRPC. Commercial Committee shall audit the Regional Energy Accounts and DSM, Reactive Energy and other Pool Accounts.

### **20.2. Composition of Commercial Sub-Committee (CSC):**

- 20.2.1. Commercial sub-committee shall be represented by the representatives of the constituent members of RPC.
- 20.2.2. The nominated representative shall be at the level of Chief Engineers in State Utilities/ General Manager in CPSEs or equivalent level conversant with commercial issues.
- 20.2.3. Member Secretary, NRPC shall be Chairperson of the CSC and preside over the meetings. Superintending Engineer of secretariat shall be convener of the CSC.

### **20.3. Meetings:**

The meeting will be held quarterly or as and when required to address the issues of urgent nature.

## **21. Protection Sub-Committee (PSC)**

### **21.1. Functions:**

Protection Sub-Committee (PSC) shall discuss all power system protection related issues viz. analysis of system disturbances in the region, review of protective relaying schemes, relay co-ordination islanding schemes, automatic under frequency load shedding schemes, review of the implementation of recommendations made by the Inquiry Committee of the grid disturbance in the region concerning the above matters, etc. and any other matter referred by the TCC/NRPC.

### **21.2. Composition of Protection Sub-Committee:**

- 21.2.1. Protection Sub-Committee shall be represented by constituent members of NRPC.



21.2.2. The nominated representative shall be at the level of Chief Engineers in State Utilities/ General Manager in CPSEs or equivalent level and concerns with power system protection / testing in the region.

21.2.3. Member Secretary, NRPC shall be Chairperson of the PC and preside over the meetings. Superintending Engineer of secretariat shall be convener of the PC.

**21.3. Meetings:**

The meeting will be held quarterly or as and when required to address the issues of urgent nature.

**22. System Study Sub-Committee (SSC):**

**22.1. Functions:**

System Study Sub-Committee shall carry out following system studies:

- i. Studies for assessment of the quantum of capacitors required in the region taking into account the expected additions in the generation and transmission systems and the low voltage conditions in the system.
- ii. Studies for review of reactive compensation requirement.
- iii. Operational load flow studies, as and when required, for peak conditions off peak conditions etc.
- iv. Short-circuit studies as and when required.
- v. Transient stability studies for major events like grid disturbances or other issues periodically or as and when requested by the constituent(s).
- vi. System studies related to transmission constraints.
- vii. Studies specific to high / low voltage conditions with specific reference to reactors or capacitors operation / requirement.
- viii. Identification of requirement of reactors as and when required
- ix. Co-relation of protection related issues from Studies as and when required.
- x. Any other technical study referred by the NRPC/TCC.

**22.2. Composition Of System Study Sub-Committee:**

22.2.1. System Study Sub-Committee shall be represented by constituent members of NRPC.

22.2.2. The nominated representative shall be at the level of Executive Engineers in State Utilities / Deputy General Manager in CPSEs or equivalent level and conversant with issues related to system studies in the region.

22.2.3. Member Secretary, NRPC shall be Chairperson of the SSC and preside over the meetings Superintending Engineer of secretariat shall be convener of this Sub-Committee.

### **22.3. Meetings:**

As and when required, as decided by the convener.

## **23. LGBR Sub-Committee**

### **23.1. Functions:**

LGBR Sub-Committee shall carry out the following functions in accordance with the provisions of Indian Electricity Grid Code:

- i. Finalise annual outage plan of generating stations.
- ii. Prepare anticipated power supply position for the next fiscal year.
- iii. Periodic review of annual outage plan of generating stations and anticipated power supply position.

### **23.2. Composition of LGBR sub-committee:**

- 23.2.1. LGBR Sub-Committee shall be represented by constituent members of NRPC.
- 23.2.2. The nominated representative shall be at the level of Chief Engineers in State Utilities/ General Manager in CPSEs or equivalent level and conversant with issues related to system studies in the region.
- 23.2.3. Member Secretary, NRPC shall be the Chairperson of the LGBR Sub-Committee and preside over the meetings. Superintending Engineer of secretariat shall be convener of the LGBR Sub-Committee.

### **23.3. Meetings:**

Meetings will be held as and when required to be decided by the convener.

## **24. Telecommunication, Scada & Telemetry (TeST) Sub-Committee**

### **24.1. Functions:**

TeST Sub-Committee shall meet to deliberate upon Telecommunication, SCADA and Telemetry schemes of NR and issues thereon in accordance with the provisions of Indian Electricity Grid Code.

### **24.2. Composition of TeST Sub-Committee:**

- 24.2.1. TeST Sub-Committee shall be represented by constituent members of NRPC.
- 24.2.2. The nominated representative shall be at the level of Chief Engineers of State Utilities/General Manager of CPSEs or equivalent level and conversant with Telecommunication, SCADA & Telemetry in the region.
- 24.2.3. Member Secretary, NRPC shall be Chairperson of the TeST Sub-Committee and preside over the meetings. Superintending Engineer of secretariat shall be convener of the TeST Sub-Committee.

### **24.3. Meetings:**

The meeting will be held as and when required to be decided by the convener.

## **25. Renewable Energy Sub-Committee (REC)**

### **25.1 Functions:**

RE Sub-Committee shall meet to deliberate upon issues related to Renewable Energy resources, its integration in grid, evacuation and other related issues.

### **25.2 Composition of RE Sub-Committee:**

- 25.2.1 RE Sub-Committee shall be represented by all ISTS connected RE generators, state RE generators having capacity 100 MW & above, MNRE, SECI, Association of RE Generators, NLDC, NRLDC, CTU, Powergrid, STU and SLDC of RE rich states where REMC is operated.
- 25.2.2 The nominated representative shall be at the level of Chief Engineers of State Utilities/General Manager of CPSEs or equivalent level and conversant with Renewable Energy domain in the region.
- 25.2.3 Member Secretary, NRPC shall be Chairperson of the RE Sub-Committee and preside over the meetings. Superintending Engineer of secretariat shall be convener of the RE Sub-Committee.

### **25.3 Meetings:**

- 25.3.1 The meeting will be held quarterly & as and when required to address the issues of urgent nature.

## **CHAPTER-IV: PROCEDURE FOR CONDUCTING SUB-COMMITTEE MEETINGS OF NRPC**

### **26. Conducting of Sub-Committee Meetings, issue of Notice, Agenda & its Minutes**

- 26.1 The notice for the above sub-committee meeting shall be issued at least 15 days before the date of meeting and agenda points one week before the meeting by the NRPC Secretariat. However, when the meeting is to be held through video conferencing, this period may be reduced to 10 days and 3 days respectively. The minutes of the meeting shall be finalized by Member Secretary and issued by NRPC Secretariat within 15 working days of the meeting.
- 26.2 The decision of the Committee arrived at for Operation of the Regional Grid and other above functions shall be implemented by the Constituents. In case the Sub-committee recommends the matter to the TCC / NRPC, for further deliberation or decision, the same shall be referred by NRPC secretariat to TCC/ NRPC.
- 26.3 The meetings will be conducted at the place and venue preferably located in the Region to be decided by Member Secretary, NRPC. In case the situations are not conducive for physical meetings, the meetings will be conducted through Video Conferencing.
- 26.4 Meeting may be hosted by the member organizations as decided by Member Secretary, NRPC in consultation with the members of the sub-committee. All the arrangements required for conducting the meeting shall be made by the host member organisation.

## **CHAPTER-V: Operation of “NRPC-Fund”**

### **27. NAME:**

The name of the fund shall be “NRPC-Fund”. The fund is accumulated amount of contribution fee collected from constituent members of NRPC.

### **28. PURPOSE:**

- i) The fund shall be utilized for meeting the reimbursement of the actual expenditure incurred (from budget provided by Central Electricity Authority) by the office of the NRPC Secretariat to the consolidated fund of Govt. of India/CEA through DDO, NRPC;
- ii) The fund shall be utilized for meeting the expenditure in the conduct of NRPC meetings, workshops, seminars etc.;
- iii) The fund shall be utilized to meet any other office expenditure considered necessary by Member Secretary, for efficient working of NRPC Sectt., with the approval of Chairman, NRPC;
- iv) The fund shall be used for meeting expenditure of NRPC Secretariat as per SOP issued by CEA.

### **29. CONTRIBUTION:**

All the Members and rotational members except the following shall contribute equally on annual basis, which shall be decided every year in NRPC meeting based on review of actual expenditure of the previous year and estimated expenditure in current/next year:

- i) NLDC/NRLDC/SLDCs
- ii) Member (Go&D), CEA
- iii) MS, NRPC
- iv) Exempted by MoP

### **30. OPERATION:**

The fund will be maintained with any Nationalized bank in the name of Northern Regional Power Committee (NRPC) and operate jointly by the nodal officer from the Constituent member along with two more signatory to be nominated with the approval of Member Secretary, NRPC on behalf of NRPC Members. The operation of account will be done under the administrative control / supervision of Member Secretary. All transaction from this account shall be through Cheque/NEFT/RTGS only.

**31. MAINTENANCE OF ACCOUNTS:**

The account of all the expenditure/receipts shall be maintained by the nodal officer (as per para 29 above) on behalf of NRPC Member. Such officer shall also maintain a cash book etc., where in details of all receipts and expenditure shall be recorded.

**32. VERIFICATION OF ACCOUNTS:**

The “NRPC – Fund” account for each financial year shall be audited as per SOP issued by CEA.

## CHAPTER-VI: REPORTS

### 33. REPORTS BY NRPC

33.1 The following reports shall be prepared and furnished by NRPC secretariat:

<b>S. No.</b>	<b>Name of the report</b>	<b>Periodicity</b>
1	Monthly Progress Report Northern Regional Grid / Operational Data	Monthly
2	Annual Report of NRPC	Annual

## CHAPTER-VII: MISCELLANEOUS

### **34. Saving of inherent Power of the NRPC**

- 34.1 Nothing in these Rules shall bar the NRPC from adopting in conformity with the Act a procedure that is at variance with provisions of these Rules, if the NRPC in view of the special circumstances of a matter or class of matters deem it necessary or expedient to deal with such a matter or class of matters.
- 34.2 Nothing in these Rules shall expressly or by implication, bar the NRPC to deal with any matter or exercise any power under the Act for which no Rules have been framed and NRPC may deal with such matters, and functions in a manner it thinks fit.

\*\*\*\*\*