



भारत सरकार

Government of India

विद्युत मंत्रालय

Ministry of Power

उत्तर क्षेत्रीय विद्युत समिति

Northern Regional Power Committee

सं. उक्षेविस/ वाणिज्यिक/ 209/ आर पी सी (71 वीं)/2024/

दिनांक: 23 फरवरी, 2024

सेवा में/To,

उ.क्षे.वि.स. के सभी सदस्य एवं विशेष आमंत्रित (संलग्न सूचीनुसार)

Members of NRPC &amp; Special Invitees (As per List)

**विषय: उत्तर क्षेत्रीय विद्युत समिति की 71 वीं बैठक का कार्यवृत्त।****Subject: 71<sup>st</sup> meeting of Northern Regional Power Committee-MoM**

महोदय/महोदया,

उत्तर क्षेत्रीय विद्युत समिति की 71 वीं बैठक दिनांक **29.01.2024 (10:30 AM)** को वीडियो कॉन्फ्रेंसिंग के माध्यम से आयोजित की गयी थी। बैठक का कार्यवृत्त संलग्न है। यह उ.क्षे.वि.स. की वेबसाइट (<http://164.100.60.165/>) पर भी उपलब्ध है।

The 71<sup>st</sup> meeting of Northern Region Power Committee (NRPC) was held on **29.01.2024 (10:30 AM)** via video conferencing. MoM of the same is attached herewith. The same is also available on NRPC Sectt. Website (<http://164.100.60.165/>).

भवदीय

Yours faithfully

Signed by Vijay Kumar  
Singh

Date: 23-02-2024 17:15:32

Reason: Approved

(वी.के. सिंह)

(V.K. Singh)

सदस्य सचिव

Member Secretary



**उत्तर क्षेत्रीय विद्युत समिति**  
**NORTHERN REGIONAL POWER COMMITTEE**



**Minutes of**  
**The 71<sup>st</sup> meeting of**  
**Northern Regional Power Committee**

**Date: 29<sup>th</sup> January 2024**

**Time: 10:30 AM**

**Via: Video Conferencing**

## Contents

A.1	Approval of MoM of the 48 <sup>th</sup> TCC & 70 <sup>th</sup> NRPC meeting.....	3
A.2	Delay in payment of Arrear Bills by PSPCL and interest on refund of arrear bills (agenda by SJVN).....	5
A.3	Conditional Payment of Energy bills by BRPL and BYPL (agenda by SJVN).....	7
A.4	Non-Opening of Letter of Credit by JKPC (formally PDD, J & K) for power supplied from NJHPS & RHPS (agenda by SJVN).....	8
A.5	OPGW installation on 400kV D/c Malerkotla-Kurukshetra line (Owned by M/s Sekura) (agenda by CTUIL).....	8
A.6	Review of communication schemes reviewed & agreed in 69th & 70th NRPC meeting in view of order of CERC on petition no. 94/MP/2021 dtd. 27.12.23 (agenda by CTUIL).....	12
A.7	Transmission system for Rajasthan REZ Ph-IV (Part-3 :6GW) & Transmission system for Rajasthan REZ Ph-IV (Part-4 :3.5GW) (agenda by CTUIL).....	15
A.8	Low voltage related issues in J&K control area (agenda by NRLDC).....	19
A.9	Implementation of islanding schemes in Agra (agenda by UPSLDC).....	24
A.10	Retaining of spare 500 MVA ICT at 400 kV Nakodar which was allocated by PGCIL as regional spare on returnable basis (agenda by PSTCL).....	25
A.11	Construction of 220/132 kV, 2X100 MVA Substation nearby Una and 220 kV (Twin Zebra) D/C line from 220/132 kV Nehrian Substation to proposed 220/132 kV, 2X100 MVA Substation near Una (agenda by HPPTCL).....	26
A.12	Mandatory Testing and Certification of Telecom Equipment (MTCTE) (agenda by NRPC Secretariat).....	28
A.13	Capacity Building Programme for Northern Regional Constituents through PSDF fund (agenda by NRPC Secretariat).....	29
A.14	Outstanding Contribution to NRPC fund (agenda by NRPC Secretariat).....	30
A.15	Outstanding Contribution from constituent member J&K (agenda by NRPC Secretariat).....	32
A.16	Approval of finalized protection philosophy for Northern Region (agenda by NRPC Secretariat).....	33
A.17	Issue of FTC for balance 765kV Bays (701, 702, 703, 705, 706) and Spare Reactor & ICT units w.r.t. M/s PMSTL at 765/400/220KV GIS Meerut substation (agenda by POWERGRID).....	33
A.18	Imposition of shutdown charges by Rajasthan Rajya Vidyut Prasaran Nigam Limited, Jaisalmer of their transmission lines for construction activities by POWERGRID, contrary to CERC Regulation (agenda by POWERGRID).....	36
A.19	Replacement of existing 420kV 50MVAR Bus Reactors at Mandola & Muradnagar substation with 125MVAR bus reactor (agenda by POWERGRID).....	37

I/34026/2024

*71<sup>st</sup> NRPC Meeting (29<sup>th</sup> January 2024)–MOM*

A.20	Scheme to relieve high loading of WR-NR Inter Regional Corridor (400 kV Bhinmal-Zerda line) (agenda by POWERGRID).....	39
A.21	Tapping arrangement for LILO of one ckt.(CKT-II) of existing 400KV D/C Ludhiana-Koldam line at proposed 400KV Substation Ropar (agenda by PSTCL).....	41
A.22	Installation of Reactive Power Solution on 33/11 kV Substations in Uttarakhand. (Rs. 58.99 Cr.) (agenda by UPCL).....	43
A.23	Implementation of Lucknow- Unchahar islanding scheme (agenda by UPSLDC).....	45

**उत्तरी क्षेत्रीय विद्युत समिति की 71<sup>वीं</sup> बैठक का कार्यवृत्त****Minutes of the 71<sup>th</sup> Meeting of Northern Regional Power Committee**Time & Date of meeting: 29<sup>th</sup> January 2024

Venue: Video-conferencing

**Minutes of Meeting**

Sh. Mohammed Shayin, Managing Director, HPGCL & Chairperson NRPC chaired the meeting. Member Secretary, NRPC welcomed the Chairperson, NRPC and other participants and after taking permission of Chair, requested EE(P) for presentation of the agenda items as given below;

**A.1 Approval of MoM of the 48<sup>th</sup> TCC & 70<sup>th</sup> NRPC meeting**

A.1.1 EE (P), NRPC apprised that minutes of the 48<sup>th</sup> TCC & 70<sup>th</sup> NRPC meeting (held on 17-18 November 2023) was issued vide letter dt. 08.12.2023. He further informed that comments on the circulated minutes have been received in NRPC Secretariat from NTPC, HPSLDC and POWERGRID.

A.1.2 After deliberation on comments received on MoM, forum approved the MoM with following inclusion/correction as below:

**Decision of the Forum:**

*Forum approved the issued MoM with following amendment:*

Agenda No.	Text as per MoM Issues	Amended Text
A.5 Guidelines/ Procedure for Certification of Open Cycle Operation of Combined Cycle Gas Based Generating Stations (agenda by NRPC Secretariat)	A.5.11 NTPC representative commented that operation of gas plant on closed cycle would depend upon the grid conditions and demand scenario.	A.5.11 NTPC representative conveyed following: (i) Rs 453 Crore is nothing but the reimbursement of differential fuel charges of Anta, Auraiya & Dadri GPS corresponding to Open Cycle scheduling for grid requirement for entire FY 2022- 23. These three stations supported grid with 452 mu during the FY 22-23, which comes out as 50 MW of average load for the year. (ii) Units were scheduled under RRAS by the Grid Operator/NLDC as per grid requirement. Presently they are utilized under TRAS & shortfall.

I/34026/2024

71<sup>st</sup> NRPC Meeting (29<sup>th</sup> January 2024)–MOM

		<p>(iii) The machines cannot be brought under combined cycle mode without continuous scheduling for the period required as per technical necessity. Many times, machines are scheduled at Tech min of one GT, when bringing ST is not possible. The grid scheduling takes place as per grid requirement, and open cycle operation becomes evident in such circumstances.</p> <p>(iv) The Open Cycle certification for reimbursement of fuel charges is necessary. It may be institutionalized as per requirement; however, the present practice of certification should continue.</p> <p>(v) Appropriate Grid security charges should be kept under consideration for supporting the grid.</p> <p>(vi) The Committee may review the Gas station operation in Open/Combined cycle, and related charges.</p>
A.14 Implementation of islanding schemes in NR (agenda by NRPC Secretariat)	A.14.4 <b>Islanding schemes of Himachal Pradesh Shimla-Solan Islanding scheme</b> The Himachal Pradesh representative informed that GE has confirmed capability of the generator working in the Power & opening mode. Further, response of GE is awaited on the switching of the generator to automatic mode.	A.14.4 <b>Islanding schemes of Himachal Pradesh Shimla-Solan Islanding scheme</b> HPSLDC apprised that as informed by HPSEBL, BHEL has confirmed that the generator of Bhaba HEP is capable of working in the power and opening mode, however, the control system at governor end is of GE make therefore they have taken up the matter with GE. But the response of GE is still awaited. Further, NRPC advised HPSEBL to expedite the matter with GE.
A.27 Extension of AMC and Upgradation of Hot Line Speech Communication System implemented by M/s ORANGE	A.27.10 POWERGRID apprised the forum that extension of AMC and Upgradation work will be done by 30th	A.27.10 POWERGRID apprised the forum that extension of AMC work will be done by 30th Nov 2023. <b>Decision of Forum-</b> POWERGRID was requested to expedite the

I/34026/2024

71<sup>st</sup> NRPC Meeting (29<sup>th</sup> January 2024)–MOM

(agenda by NRLDC)	Nov 2023.  <b>Decision of Forum-POWERGRID</b> was requested to expedite the extension of AMC and Upgradation work latest by 30th Nov 2023.	extension of AMC work latest by 30th Nov 2023.
-------------------	--	--

**A.2 Delay in payment of Arrear Bills by PSPCL and interest on refund of arrear bills (agenda by SJVN)**

**A.2.1** SJVN representative apprised that they had to file petitions before CERC for recovery of the Expenditures incurred by SJVN over the years. If the information furnished in the petition is in accordance with the regulations and is adequate for carrying out prudence check of the claims made, the Commission shall consider the suggestions and objections, if any, received from the respondents within one month from the date of filing of the petition and any other person including the consumers or consumer associations. The Commission shall issue the tariff order after hearing the petitioner, the respondents and any other person specifically permitted by the Commission.

**A.2.2** Point 11 to 13 of Clause 8 Chapter 13 of Tariff Regulation 2014-19 is reiterated below:

*(11) Where after the truing up, the tariff recovered exceeds the tariff approved by the Commission under these regulations, the generating company or the transmission licensee, shall refund to the beneficiaries or the long-term transmission customers /DICs, as the case may be, the excess amount so recovered as specified in the Clause 13 of this regulation.*

*(12) Where after the truing up, the tariff recovered is less than the tariff approved by the Commission under these regulations, the generating company or the transmission licensee shall recover from the beneficiaries or the long-term transmission customers / DICs, as the case may be, the under-recovered amount as specified in the Clause 13 of this regulation.*

*(13) The amount under-recovered or over-recovered, along with simple interest at the rate equal to the bank rate as on 1st April of the respective year, shall be recovered or refunded by the generating company or the transmission licensee, as the case may be,*

I/34026/2024

71<sup>st</sup> NRPC Meeting (29<sup>th</sup> January 2024)–MOM

*in six equal monthly instalments starting within three months from the date of the tariff order issued by the Commission.*

- A.2.3** As per Clause 8(13) of CERC regulation, Generators have to raise Arrear Bills within three months from the receipt of Tariff Order from CERC. Based on above clauses, SJVN is raising arrear bills to its beneficiaries of NJHPS and RHPS after receipt of CERC orders from time to time. The Arrear bills are to be recovered or refunded as per CERC order in single instalments or multiple instalments.
- A.2.4** Further, he stated that PSPCL had unilaterally taken the repayment date on 90<sup>th</sup> day from the date of issue of Tariff order instead of SJVN bill issue date.
- A.2.5** The Clause 8(13) of CERC regulation is very clear, arrear bills can be issued within three months from the date of tariff order rather than payment of Energy Bills from the date of Tariff order.
- A.2.6** While, PSPCL had deducted interest on negative arrear bills. This had resulted into accumulation of Late Payment Surcharge (LPS).
- A.2.7** PSPCL may be directed to treat the bill date when the bills had been issued and not to charge any interest negative bills which is contrary to any CERC regulation. Further, PSPCL may be directed to pay the LPS on delayed payments to avoid any penal action provided in CERC regulation.
- A.2.8** He informed that the matter was discussed in 68th NRPC meeting (18th August 2023) wherein both parties agreed to solve the matter mutually.
- A.2.9** Further, the agenda was discussed in 48th Commercial Sub-Committee Meeting (held on 04.12.2023). Forum agreed that PSPCL is not in compliance with CERC regulation. Therefore, PSPCL was advised to resolve this issue in accordance with CERC regulation and PSPCL agreed to solve the case in line with CERC regulation.
- A.2.10** SJVN representative highlighted that till now no action has been done by PSPCL in this regard.
- A.2.11** There was no representative from PSPCL in the meeting.
- A.2.12** Chairperson, NRPC take serious note of absence of PSPCL in meeting.

***Decision of Forum:***

*Forum deferred the agenda as there was no representation from concerned office of PSPCL.*

**A.3 Conditional Payment of Energy bills by BRPL and BYPL (agenda by SJVN)**



I/34026/2024

71<sup>st</sup> NRPC Meeting (29<sup>th</sup> January 2024)–MOM

- A.3.1 SJVN representative apprised that SJVN is supplying power to Delhi's Discoms from Nathpa Jhakri Hydro Power Project as per allocation order issued by MOP, GOI. Further, DERC had assigned power of Delhi (formally DTL) to BRPL, BYPL and TPDDL.
- A.3.2 Energy bills are being raised as per the terms of PPA and tariff determined by CERC. The payments are to be made by the beneficiaries as per the CERC rules and regulation and terms of the Power Purchase Agreement.
- A.3.3 He highlighted that SJVN is receiving timely payments from these Discoms, however, BRPL and BYPL is making the conditional payments without assigning any reason and by mentioning in their letter "Without Prejudice". BRPL and BYPL should specifically address the concern or objection through Letters and correspondences.
- A.3.4 He had already recommended that BRPL and BYPL may be requested to kindly issue Payment Receipt Letters without mentioning of the "Without Prejudice" remark as it leads to Audit Objection by the SJVN Auditors.
- A.3.5 EE (P), NRPC informed that the matter was discussed in the 70th NRPC meeting, wherein BRPL was suggested not to mention such words (i.e. "Without Prejudice") if SJVN is not party to writ.
- A.3.6 SJVN representative submitted that as of now, it has not been taken into consideration by BRPL and BYPL. It is wasting time and resources of SJVN to face the issue continuously.
- A.3.7 CGM, NRLDC asked NTPC about facing of same issues with Delhi DISCOMs.
- A.3.8 NTPC representative informed that Delhi DISCOMs write in their letters "Without Prejudice" for bills payments. We also reply to them for not mentioning such words.
- A.3.9 Representatives from BSES did not attend the meeting.
- A.3.10 MS, NRPC advised SE (Commercial), NRPC to have a separate meeting with SJVN and Delhi DISCOMs to resolve the same.

***Decision of Forum:***

*Forum decided to have a separate meeting with SJVN and Delhi DISCOMs to resolve the same.*

- A.4 Non-Opening of Letter of Credit by JKPCL (formally PDD, J & K) for power supplied from NJHPS & RHPS (agenda by SJVN)**

I/34026/2024

71<sup>st</sup> NRPC Meeting (29<sup>th</sup> January 2024)–MOM

- A.4.1** SJVN representative apprised that as per mutually signed Power Purchase Agreement and MOP, GOI various order/ gazette Notifications (e.g. 28.06.2019, 21.02.2021 and 03.06.2022), Beneficiary has to establish Letter of Credit in line with payment security Mechanism.
- A.4.2** The established LC should be confirmed, revolving, irrevocable and in favour of SJVN for an amount equivalent to 105% of average monthly billing of preceding 12 months with appropriate bank as mutually acceptable to both the parties. The LC shall be kept valid at all the time during the validity of the Power Purchase Agreement.
- A.4.3** He added that in spite of repeated reminders, JKPCCL had not opened Letter of Credit after 13.11.2019 for power supplied from NJHPS and RHPS. As such JKPCCL may be advised to submit Letter of Credit in favour of SJVN at the earliest.
- A.4.4** The matter was discussed in the 70<sup>th</sup> NRPC meeting, wherein J&K was addressed to expedite the process of LC opening.
- A.4.5** Further, the same agenda was discussed in 48<sup>th</sup> Commercial Sub-Committee meeting, wherein no representative from J&K was present in the meeting.
- A.4.6** J&K representative informed that matter has been taken up with finance department and some queries are to be addressed.
- A.4.7** MS, NRPC highlighted that DO letter has been sent to J&K Govt. and matter of non-opening of LC is pending for a lot of utilities including SJVN.

***Decision of Forum:***

*Forum requested J&K to expedite the process of opening of Letter of Credit for all concerned utilities.*

- A.5 OPGW installation on 400kV D/c Malerkotla-Kurukshetra line (Owned by M/s Sekura) (agenda by CTUIL)**
- A.5.1** CTUIL representative apprised that Reliable Communication Scheme for Central Sector in Northern region covering installation of 7398 kms OPGW was agreed for implementation by POWERGRID in the 39<sup>th</sup>, 40<sup>th</sup> & 47<sup>th</sup> NRPC meetings held on 02.05.2017, 28.10.2017 & 11.12.2019 respectively.
- A.5.2** As part of the above Scheme, Installation of OPGW (180km) on 400kV D/c Kurukshetra - Malerkotla line by POWERGRID through replacing the existing earth wire was also

I/34026/2024

71<sup>st</sup> NRPC Meeting (29<sup>th</sup> January 2024)–MOM

envisaged. It is pertinent to mention that 400kV Kurukshetra - Malerkotla transmission line was implemented under TBCB route & owned by M/s NRSS-XXXI (B) Trans Ltd (NTL) (M/s Sekura) & was commissioned on 18.01.2017 with Two Earthwire(s) without OPGW as per the relevant RFP.

- A.5.3 However, due to issues raised by M/s Sekura, like ownership of OPGW, identification towards outage/ tripping during the installation of OPGW and return of the earth wire replaced by OPGW etc. The work could not be started.
- A.5.4 In this regard, a petition vide No. 94/MP/2021 had been filed by CTU before Hon'ble Central Electricity Regulatory Commission (CERC) seeking directions regarding installation of OPGW on the 400kV Kurukshetra - Malerkotla transmission line.
- A.5.5 In the 62<sup>nd</sup> NRPC meeting, OPGW installation on the 400kV Kurukshetra - Malerkotla line was deliberated as POWERGRID has communicated to CTU that they have no objection if the implementation of laying of OPGW is undertaken by M/s Sekura, same was submitted by CTU before CERC on 29<sup>th</sup> Mar'22 in the compliance certificate.
- A.5.6 As per MoM of 62<sup>nd</sup> NRPC meeting (Relevant extract of MOM attached at **Annexure-I**) forum noted that issue may be worked out by CTU, POWERGRID and M/s Sekura and Hon'ble CERC may be apprised accordingly for decision on the matter. In view of this, CTU has convened various meetings and apprised CERC accordingly.
- A.5.7 CERC has issued the order of the said petition on 27.12.2023 (attached at **Annexure-II**). Which contains the text of minutes of meeting held on 08.05.2023 between CTUIL and ISTS licensees.
- A.5.8 After the views of NRPC the scheme as advised in the said CERC order shall be put up by CTU to NCT for approval as per MoP Guidelines on Planning of Communication System for Inter-State Transmission System (ISTS) dtd. 09.03.2022.
- A.5.9 Details of Scheme are proposed as below:

Name of Scheme - **OPGW installation on existing 400 kV Kurukshetra - Malerkotla line along with FOTE at both ends.**

Scheme has been bifurcated into two nos. as below for OPGW and FOTE:

- (a) OPGW installation on existing 400 kV Kurukshetra - Malerkotla line along with FOTE at both ends – Part-A**

S. No.	Items	Details
1.	Scope of the scheme	Supply and installation of 24 Fibre OPGW on 400 kV Kurukshetra - Malerkotla line (140 kms.)

I/34026/2024

71<sup>st</sup> NRPC Meeting (29<sup>th</sup> January 2024)–MOM

2.	Objective Justification	OPGW installation on 400 kV D/c Kurukshetra - Malerkotla line (180 kms.) was approved in the 39th, 40th & 47th NRPC meetings held on 02.05.2017, 28.10.2017 & 11.12.2019 respectively as part of reliable communication scheme to provide Reliable and Redundant communication to the ISTS wide band nodes of Northern Region.  As per CERC order of petition no. 94/MP/2021 dtd. 27.12.23, CTU proposal was agreed by CERC where OPGW work may be awarded to Transmission line asset owner.  M/s NRSS-XXXI (B) Transmission Ltd. is the asset owner of transmission line in this case.
3.	Estimated Cost	Rs. 9 crores (approx.) (excluding taxes and duties)
4.	Implementation timeframe	18 months from the date of allocation
5.	Implementation Agency	M/s NRSS-XXXI (B) Transmission Ltd.
6.	Implementation mode	As per CERC petition order 94/MP/2021 dtd. 27.12.23 under "Change in Law" of TSA

- A.5.10 CTUIL representative highlighted that OPGW installation was not in the scope of TSA for NRSS XXXI (B). He mentioned about CERC order that *"The transmission licensee is directed to follow a transparent process of competitive bidding while implementing such work. After implementation of the work, the transmission licensee is required to approach the Commission for approval of such expenditure along with audited data of the expenditure and details of competitive bidding carried out by it."*
- A.5.11 In view of above, CTU conveyed that Licensee needs to approach CERC for its tariff recovery mode under "change in Law" of TSA along with the documents as mentioned in the CERC order.
- A.5.12 Sekura representative also agreed upon the same and ready to do the work.
- A.5.13 Further, Sekura representative highlighted that implementation time frame for OPGW installation has been proposed for 18 months. While for FOTE installation, the same has been proposed for 12 months. He expressed concerns for different time frame of both activities and suggested for same time frame for both. So that overall scheme will be operational simultaneously.
- A.5.14 POWERGRID representative also agreed upon the proposal of Sekura of same time for both activities.

I/34026/2024

71<sup>st</sup> NRPC Meeting (29<sup>th</sup> January 2024)–MOM

A.5.15 Subsequently, it was decided finally that both part (OPGW and FOTE) should be commissioned in sync and maximum timeline shall be 18 months from the date of allocation.

**(b) OPGW installation on existing 400 kV Kurukshetra - Malerkotla line along with FOTE at both ends – Part-B**

S. No.	Items	Details
1.	Scope of the scheme	FOTE (STM-16) at Kurukshetra & Malerkotla locations (2 nos.)
2.	Objective / Justification	OPGW installation on 400 kV Kurukshetra - Malerkotla line (180 kms.) was approved in the 39th, 40th & 47th NRPC meetings held on 02.05.2017,28.10.2017 & 11.12.2019 respectively as part of reliable communication scheme to provide Reliable and Redundant communication to the ISTS wide band nodes.  As per CERC order of petition no. 94/MP/2021 dtd. 27.12.23, CTU proposal was agreed by CERC where OPGW work may be awarded to Transmission line asset owner. POWERGRID is the bay owner at both ends.
3.	Estimated Cost	0.6 crore (approx.) (excluding taxes and duties)
4.	Implementation timeframe	12 months from the date of allocation
5.	Implementation Agency	POWERGRID
6.	Implementation mode	<b>Implementation mode – To be deliberated</b>

A.5.16 CTU stated that CERC order of petition no. 94/MP/2021 dtd. 27.12.23 has mentioned methodology for installation of OPGW under change in law of TSA. However, order has no mention of methodology for installation of FOTE.

A.5.17 Further, CTU representative recommended that both bays at Kurukshetra & Malerkotla were commissioned under RTM and owned by POWERGRID. Therefore, FOTE installation may be implemented under RTM mode.

A.5.18 CGM, NRLDC stated that post implementation work in a TBCB project will be implemented under “Change in Law” of TSA as per CERC order. Further, the same CERC order does not have any direction for RTM mode.

I/34026/2024

71<sup>st</sup> NRPC Meeting (29<sup>th</sup> January 2024)–MOM

- A.5.19 NRLDC representative stated that if port is available in FOTE at both ends then communication channel may be integrated to the same without any new FOTE installation.
- A.5.20 POWERGRID informed that available equipment are fully utilized at both ends. Therefore, new FOTE installation needs to be done.
- A.5.21 Subsequently, it was agreed upon that new FOTE at both locations may be implemented under RTM mode.

### **Decision of Forum**

*After detailed deliberation, Forum decided the followings-*

1. *Supply and installation of 24 Fibre OPGW on 400 kV Kurukshetra - Malerkotla line may be done by M/s NRSS-XXXI (B) Transmission Limited under "Change in Law" of TSA.*
2. *FOTE (STM-16) at Kurukshetra & Malerkotla locations (2 nos.) may be implemented by POWERGRID under RTM.*
3. *Above both parts should be commissioned in sync and maximum timeline shall be 18 months from the date of allocation.*

### **A.6 Review of communication schemes reviewed & agreed in 69th & 70th NRPC meeting in view of order of CERC on petition no. 94/MP/2021 dtd. 27.12.23 (agenda by CTUIL)**

**A.6.1** CTUIL representative apprised that four nos. of schemes were reviewed & agreed in the 69<sup>th</sup> & 70<sup>th</sup> NRPC meeting held dtd. 27.09.2023 & 18.11.2023 respectively (relevant extract of MOM attached at **Annexure-III**). Subsequently before approval in NCT of said schemes, CERC has issued order on petition no. 94/MP/2021 dtd. 27.12.23.

**A.6.2** In view of this order, the already reviewed & agreed schemes need to be re-deliberated with respect to implementation mode. The schemes are as under-

- i. **Scheme Name:** OPGW installation on existing 400 kV Kota – Merta line alongwith LILO portion at Shree Cement.

**Scheme Scope:** OPGW installation on existing 400 kV Kota – Merta line (256Km.) alongwith LILO portion at Shree Cement(55Km.) (Total 311Km.) including 3 no. FOTE.

- a. Estimated Cost: Rs. 18.5 crore (approx.) (excluding taxes and duties).
- b. Implementation timeframe: 24 months from the date of allocation.

I/34026/2024

71<sup>st</sup> NRPC Meeting (29<sup>th</sup> January 2024)–MOM

- c. Implementation Agency: POWERGRID.
- d. Implementation mode: **To be deliberated** for **RTM**.

**A.6.3** CTUIL representative informed that the 400KV Kota – Merta line was constructed by POWERGRID under RTM mode. Further, OPGW installation on the above line including LILO portion to be done by POWERGRID as agreed in the 69<sup>th</sup> NRPC meeting.

**A.6.4** Further, he highlighted that as per CERC order in petition no. 94/MP/2021 dtd. 27.12.23, the owner of line may be allocated for OPGW installation. Therefore, POWERGRID may complete the work under RTM mode as line was constructed by them under RTM.

### **Decision of Forum**

*Forum accorded the approval of OPGW installation on existing 400 kV Kota – Merta line along with LILO portion at Shree Cement including three number FOTE under RTM by POWERGRID.*

ii. **Scheme Name:** Redundant communication for Fatehgarh-I (Adani)

**Scheme Scope:** Supply and installation of OPGW on 400kV Fatehgarh I (Adani) - Fatehgarh-II (PG) line (6.5 kms.) (Fatehgarh-I (Adani) – Bhadla(PG) line LILOed at Fatehgarh-II.

- a. Estimated Cost: Rs. 32.5 Lakhs (approx.) (excluding taxes and duties)
- b. Implementation timeframe: 18 months from the date of allocation
- c. Implementation Agency: M/s Adani Transmission Ltd.
- d. Implementation mode: **To be deliberated under “Change in Law” of**

### **TSA**

**A.6.5** CTUIL representative conveyed that it was TBCB project. Therefore, it may be agreed upon to be implemented under “Change in Law” of TSA by M/s Adani Transmission Ltd.

**A.6.6** ATIL representative commented that in 69<sup>th</sup> NRPC meeting, the same work was decided to be implemented under RTM. However, forum may reconsider the implementation mode in line with CERC petition.

**A.6.7** ATIL representative raised the concern for recovery of estimated cost under “Change in Law” of TSA.

I/34026/2024

71<sup>st</sup> NRPC Meeting (29<sup>th</sup> January 2024)–MOM

- A.6.8** Subsequently, it was gathered that as per CERC order licensee needs to approach CERC for its tariff recovery mode under “change in Law” of TSA along with the required documents.

***Decision of Forum:***

*Forum accorded the approval of supply and installation of OPGW on 400kV Fatehgarh I (Adani) - Fatehgarh-II (PG) line (6.5 kms) under “Change in Law” of TSA by Adani Transmission Ltd.*

- iii. **Scheme Name:** Additional equipment at in view of resource disjoint and critical locations

**Scheme Scope:** Supply and Installation of 12 nos. new FOTE and additional ethernet cards (125 nos.) for existing FOTE in view of resource disjoint and critical locations.

- a. Estimated Cost: Rs. 5.2 Crores approx. (excluding taxes and duties)
- b. Implementation timeframe: 12 months from the date of allocation
- c. Implementation Agency & Mode: **To be deliberated for RTM.**

- A.6.9** POWERGRID representative informed that 12 locations are basically related to SLDCs interconnection and should be executed under RTM.

- A.6.10** NRLDC representative highlighted that the installation of 12 nos. new FOTE and additional ethernet cards (125 nos.) for existing FOTE needs to be expedited by POWERGRID.

- A.6.11** MS, NRPC requested POWERGRID to complete the work within timeframe.

***Decision of Forum:***

*Forum accorded the approval of Supply and Installation of 12 nos. new FOTE and additional ethernet cards (125 nos.) for existing FOTE under RTM by POWERGRID.*

- iv. **Scheme Name:** FOTE at Backup SLDCs in NR & Backup NRLDC

**Scheme Scope:** Supply and Installation of 11 nos. FOTE equipment at Backup SLDCs in NR & Backup NRLDC.

- a. Estimated Cost: Rs. 3.3 Crores approx. (excluding taxes and duties)
- b. Implementation timeframe: 12 months from the date of allocation
- c. Implementation agency and Mode: **To be deliberated for RTM**



I/34026/2024

71<sup>st</sup> NRPC Meeting (29<sup>th</sup> January 2024)–MOM

- A.6.12** CTUIL representative asked POWERGRID that the above-mentioned work are related to SLDC and NRLDC, therefore it may be proposed under RTM.
- A.6.13** POWERGRID representative also recommended for RTM mode for the same.
- A.6.14** Forum agreed on proposal of CTU for implementation by POWERGRID under RTM.
- A.6.15** CTUIL representative informed that UNMS system has been commissioned in Northern Region. Terminals have been provided for Grid-India. Terminal is also being extended to NRPC Secretariat by March 2024.
- A.6.16** Further, CTUIL representative added that a training (both in offline and online mode) for the same was provided to all the concerned stakeholders i.e. State Constituents, RLDC, CEA, POWERGRID and CTU, etc.
- A.6.17** Considering above, STUs/ ISTS users were requested to start using the UNMS system for supplementing the RPC deliberation for the upcoming Communication schemes while using UNMS features related to fault restoration, alternate path identification and congestion identification, inventory availability etc.

***Decision of Forum:***

*Forum accorded the approval of Supply and Installation of 11 nos. FOTE Equipment at Backup SLDCs in NR & Backup NRLDC under RTM by POWERGRID.*

**A.7 Transmission system for Rajasthan REZ Ph-IV (Part-3 :6GW) & Transmission system for Rajasthan REZ Ph-IV (Part-4 :3.5GW) (agenda by CTUIL)**

**a) Rajasthan REZ Ph-IV (Part-3 : 6 GW)**

- A.7.1** CTUIL representative apprised that the scheme of transmission system is for evacuation of power from Bikaner complex as part of Rajasthan REZ Ph-IV (Part-3: 6GW) & transmission system for evacuation of power from Fatehgarh/Barmer Complex as part of Rajasthan REZ Ph-IV (Part-4 :3.5GW).
- A.7.2** He further added that the 3.6GW part of RE evacuation was approved in 70<sup>th</sup> NRPC meeting. However, the same could not be taken for further approval in NCT as during planning stage for remaining 2.4GW part of it, review of scheme was done comprehensively in respect of cost optimization.

I/34026/2024

71<sup>st</sup> NRPC Meeting (29<sup>th</sup> January 2024)–MOM

- A.7.3 Meanwhile, an alternative was found for implementation of all 6GW scheme with 1000cr.- 1200cr. saving in cost based on the stakeholder comments.
- A.7.4 Joint study meetings were held on 28.12.23 & 09.01.24 to deliberate & finalize the Transmission system for evacuation of power from Bikaner & Fatehgarh/Barmer Complex. Minutes of the meeting is attached as **Annexure- IV**.
- A.7.5 The estimated cost of scheme of transmission system for evacuation of power from Rajasthan REZ Ph-IV (Part-3: 6GW) (Bikaner complex) is Rs 11400Cr. The detailed scheme is attached as **Annexure- V**.
- A.7.6 Further, the same proposal was also approved in the 27<sup>th</sup> CMETS meeting of Northern region held on 10.01.2024.
- A.7.7 NRLDC stated that the scheme is already discussed in separate meeting with CTUIL, NLDC & CEA. It was further mentioned that the document issued by CEA in December 2022 titled “Transmission System for Integration of over 500 GW RE Capacity by 2030” mentions that  
*“For the planned transmission schemes in Northern Region, dynamic compensation requirement like STATCOMs, Synchronous Condensers etc. would be identified separately based on the detailed reactive power planning studies and the Short Circuit Ratios (SCRs) at different locations. Requirement of Synchronous condensers based on inertia considerations will also be assessed based on detailed studies.”*
- A.7.8 As of now only STATCOMs are being planned in transmission system and planning of synchronous condenser is yet to be materialised. Therefore, the same may be strongly taken up by CTUIL & CEA as with concentration of RE in western Rajasthan issues such as grid stability and inertial requirement are on the rise. Therefore, such studies also need to be carried out at planning level which could provide recommendations related to synchronous condenser or other suitable solutions to tackle such issues as being done by other countries in the world where RE power is being integrated at fast pace.
- A.7.9 Further, he conveyed that some countries such as Britain are also in process of including markets for inertia & accordingly synchronous condensers are being brought on bar based on market participation. It was further highlighted that GRID-INDIA had already submitted international experience on synchronous condenser in paper titled Voltage Control Ancillary Service to CERC in March 2021 and is available in public domain.

I/34026/2024

71<sup>st</sup> NRPC Meeting (29<sup>th</sup> January 2024)–MOM

- A.7.10 MS NRPC stated that such issues were also raised by Chief Engineer, RA division, CEA in 70 NRPC meeting and accordingly the same may be studied.
- A.7.11 CTUIL representative stated that as per the information gathered and analysis done at CTUIL level, efficacy of STATCOM has been observed to be more than synchronous condenser for dynamic compensation and accordingly as of now STATCOMS have been proposed at both Siwani and Bikaner-IV substations. He also supported that synchronous condenser may support inertial requirement in the grid in general but its location & efficacy may also be in other than Rajasthan region which can be explored after discussion with stakeholders.
- A.7.12 NRLDC proposed a general consideration to have detailed study on dynamic compensation of reactive power and short circuit ratio. Accordingly, STATCOM or synchronous condenser may be planned. In this scheme, there is no issue and can be approved.
- A.7.13 He recommended to enhance the planning of synchronous condenser in Bhadla complex as there may be less inertia in future due to large scale integration of RE.
- A.7.14 In view of above, he suggested for formation of a committee to do futuristic analysis for dynamic compensation, stability/inertial problems based on manufacturing company inputs and best practices available in other countries.
- A.7.15 MS, NRPC appreciated the suggestion of NRLDC and agreed upon the same.
- A.7.16 NRLDC further enquired about the SCR in the RE complex with the proposed scheme. It was mentioned that in recent time, on several occasions, it has been observed that SCR is on the lower side in Western Rajasthan RE complex. Further, STATCOMS may also be commissioned in matching timeframe as the transmission scheme.
- A.7.17 CTUIL representative stated that minimum SCR of 5 is being ensured with the proposed scheme. Further, now different packages of transmission schemes are being generally taken up simultaneously so that packages are now implemented with near same timeframe and deviation of different packages in commissioning timeframe is also minimised for all future schemes.
- A.7.18 NRLDC requested CTUIL to ensure timely commissioning of planned STATCOMs and CTUIL may refer to the Voltage Control Ancillary Service report prepared by Grid-India.

**b) Rajasthan REZ Ph-IV (Part-4 :3.5GW)**

- A.7.19 Further, CTUIL representative briefed that the estimated cost of scheme of transmission system for evacuation of power from Rajasthan REZ Ph-IV (Part-4 :3.5

I/34026/2024

71<sup>st</sup> NRPC Meeting (29<sup>th</sup> January 2024)–MOM

GW) (Fatehgarh/Barmer) Complex is Rs. 12,200 Cr. The detailed scheme is attached as **Annexure- VI**.

- A.7.20 MS, NRPC enquired with UPPTCL about their system for load at Ghiror.
- A.7.21 UPPTCL representative informed that system substation & onward system is ready at Firozabad as load center. No constraint has been observed during the load flow study done jointly with CTUIL.
- A.7.22 CTUIL representative desired to know OPGW availability on the 765 kV Aligarh (PG) - Orai (PG) D/c line and 765kV Agra (PG) – Fatehpur(PG) D/c line, which are planned to be LILOed at Ghiror as mentioned in the scheme attached as **Annexure- VI**.
- A.7.23 Based on the availability of OPGW, requirement of the same may be included in the planned scheme.
- A.7.24 POWERGRID representative answered that OPGW is available on 765 kV Aligarh (PG) -Orai (PG) and not available on and 765kV Agra (PG) – Fatehpur(PG). Further, CTUIL representative also asked POWERGRID whether both circuits are on same tower or on different tower for 765kV Agra (PG) – Fatehpur (PG) D/c line.
- A.7.25 On this, POWERGRID assured to reply to CTUIL after confirmation from concerned office.
- A.7.26 POWERGRID added that both circuits are on different towers as there is 2xS/c line configuration. Therefore, in the scheme it may be mentioned that OPGW to be installed in the circuit which is proposed for LILO. Line length is 325 km. OPGW cost may be around INR 16.50 Cr including FOTE.
- A.7.27 CTUIL representative conveyed that based on POWERGRID reply, the OPGW installation may be added to this proposed scheme. The OPGW installation works may be made part of scheme as per MOP guidelines dated 09.03.2022 under category-A.
- A.7.28 CTUIL representative conveyed that based on POWERGRID reply, the OPGW installation may be considered to this proposed scheme.
- A.7.29 After deliberation, forum approved the proposal of CTU.

### **Decision of Forum**

1. *Forum technically approved the proposal of CTUIL regarding Transmission system for Rajasthan REZ Ph-IV (Part-3 :6GW) & Transmission system for Rajasthan REZ Ph-IV (Part-4 :3.5GW) and recommended to NCT.*

I/34026/2024

71<sup>st</sup> NRPC Meeting (29<sup>th</sup> January 2024)–MOM

2. *To do futuristic analysis for dynamic compensation, stability/inertial problems in the Grid, a committee will be formed having members from CTUIL, STUs, NRLDC, NRPC and CEA.*
3. *OPGW installation on 765kV Agra (PG) – Fatehpur (PG) D/c line may also be considered part of Ph-IV (Part-4 :3.5GW) scheme.*

#### **A.8 Low voltage related issues in J&K control area (agenda by NRLDC)**

- A.8.1** NRLDC representative apprised that J&K grid being weakly connected from the rest of the grid and due to its isolated location suffers from issues of severe low voltage. During winter months when hydro generation is not available and demand in J&K control area is high due to heating load requirements, the issue of low voltage gets aggravated.
- A.8.2** J&K also has to pay large amounts as reactive energy charges to pool due to high MVAR drawl from ISTS grid at the time of low voltage.
- A.8.3** It has been discussed and suggested to J&K to plan & expedite commissioning of reactive power devices especially capacitors at lower voltage level to improve the voltage profile in valley area and also avoid large sums payable as reactive energy charges.
- A.8.4** Low voltage related issues of J&K (UT) and Ladakh (UT) has been regularly shared by NRLDC with CEA and CTUIL in Grid-India's quarterly operational feedback report. The issue has been continuously raised in NRPC as well as OCC meetings still the issues of low voltage persist in J&K especially Kashmir valley.
- A.8.5** As can be seen from recent trends, 400kV voltages are reaching 370kV at Amargarh, Wagoora and Wanpoh substations. Even the SVC at New Wanpoh is being fully utilized and no margin is available for dynamic support. Plots of 400kV and 220kV bus voltages of Amargarh, Wagoora and Wanpoh substations for Jan 2024 are shown below:

71<sup>st</sup> NRPC Meeting (29<sup>th</sup> January 2024)–MOM

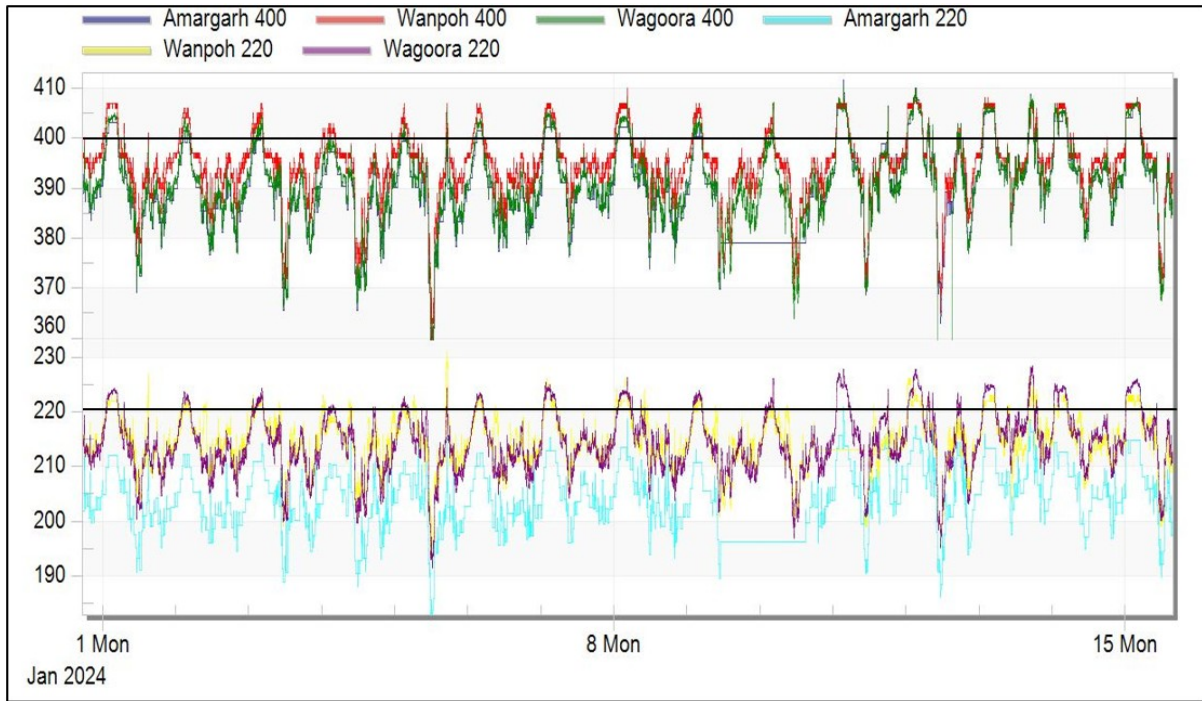

**A.8.6** Pattern of MW and MVAR drawl by 400/220kV ICTs at ISTS substations such as Amargarh, Wagoora and New Wanpoh suggest that there is urgent requirement of reactive power compensation in intrastate network.

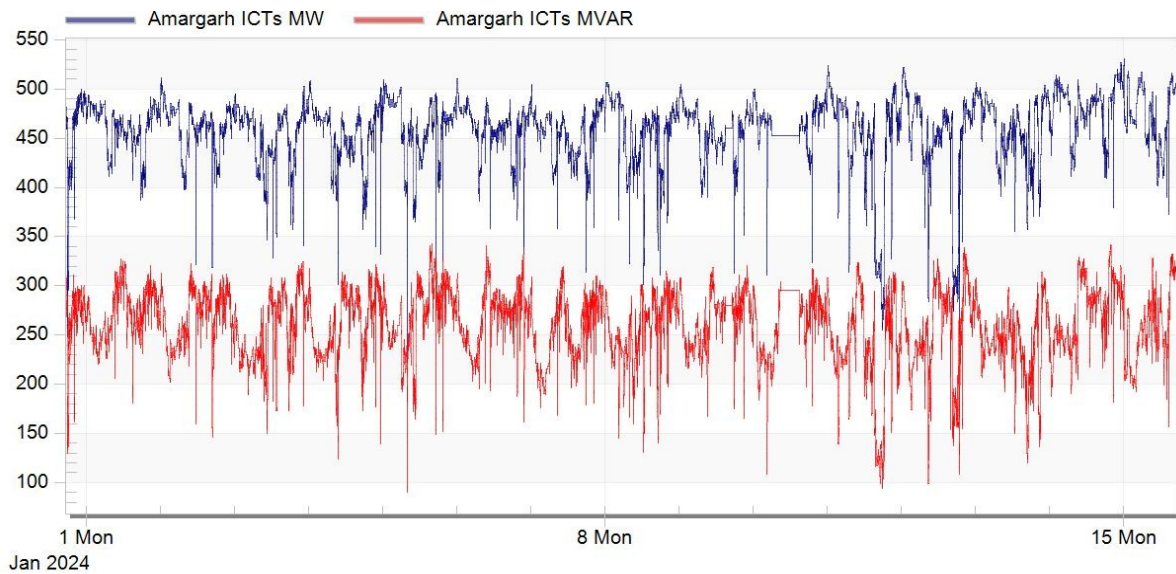

I/34026/2024

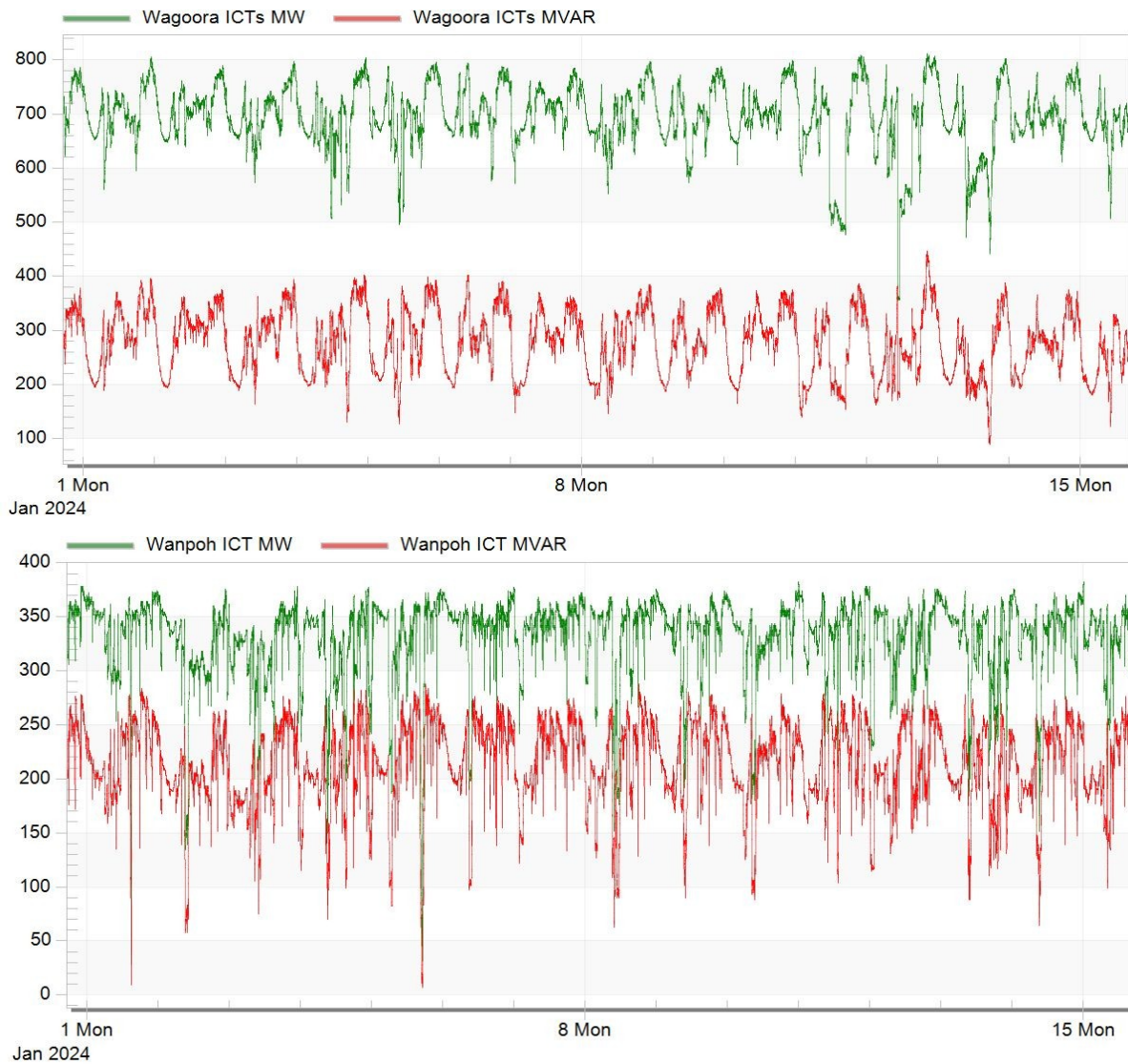
71<sup>st</sup> NRPC Meeting (29<sup>th</sup> January 2024)–MOM

**A.8.7** From the plots it is clear that the reactive drawl is at least half of the MW drawl of 400/220kV ICTs. This increases % loading of transmission elements and also leads to low voltages in the grid. The power factor at 400/220kV ISTS substations is in range of 0.8-0.9.

**A.8.8** Further, low voltages are also being observed in Ladakh area also during winter months as shown below-

I/34026/2024

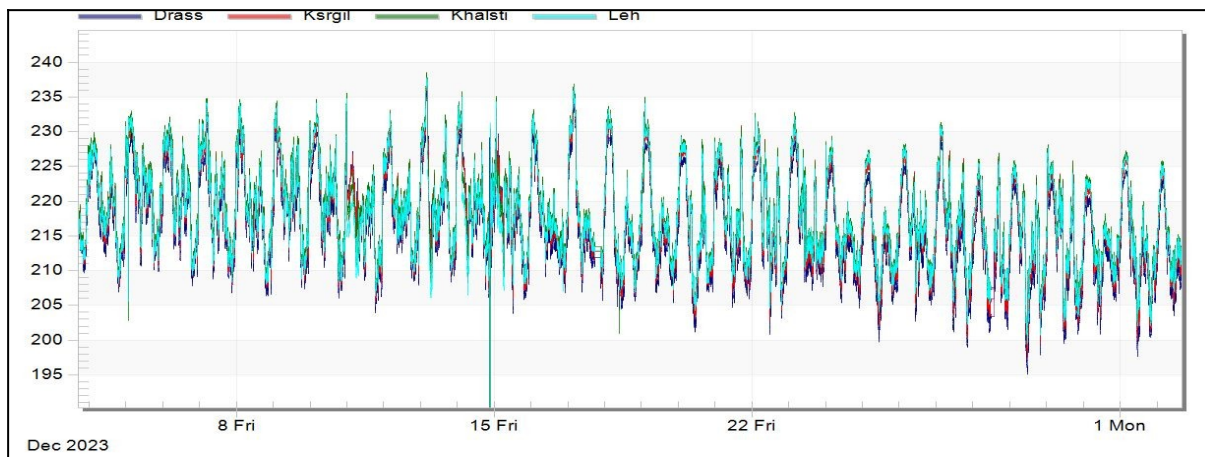
71<sup>st</sup> NRPC Meeting (29<sup>th</sup> January 2024)–MOM

**A.8.9** In special meeting taken by NRPC with J&K, following was discussed w.r.t. low voltages in J&K control area:

*NRLDC representative requested that following may be shared by J&K:*

- *List of nodes & node wise capacitor bank requirement (as finalised by JPDCL, KPDCL & JKPTCL)*
- *Tentative timeline for tendering and commissioning of capacitor banks*
- *List of nodes in J&K and Ladakh facing low voltage issues along with the voltage profile*
- *Status of 350MVAR capacitor bank at 11 kV under progress.*

*JPDCL representative informed that at present 392MVAR capacitor is functional. Further, 720 MVAR capacitors are also under proposal/implementation as per RDSS (Revamped Distribution Sector Scheme) scheme.*

*JKPTCL representative informed that at present 323MVAR is commissioned in transmission level out of which 240MVAR is functional. The faulty capacitors would be readied by end of this year. Further, new capacitors have been proposed under capital expenditure.*

*MS, NRPC expressed concern on the issue highlighted by NRLDC and asked J&K to expedite their actions. It was also informed that if required, PSDF proposal may also be submitted by J&K for works related to System Improvement.*

**A.8.10** NHPC representative stated that the voltages are also remaining low in Uri & Uri-II hydro stations. Low voltage at these stations is also stressing hydro units at these stations.



I/34026/2024

71<sup>st</sup> NRPC Meeting (29<sup>th</sup> January 2024)–MOM

- A.8.11** In the meeting, it was discussed that capacitors and supply of reactive power at local level is the only solution.
- A.8.12** J&K representative stated that only 78MVAR capacitors are functional as on date in Kashmir area. They shall submit plan to improve the voltage profile in the area. It was further informed that 220kV Alusteng-Mirabzar is under commissioning and 50km line works are pending and the line is expected to be charged before next winter.
- A.8.13** NRLDC representative also asked JKPTCL, JPDCL and KPDCL to expedite the commissioning of number of transmission elements that are being implemented in J&K control area including those funded by PMDP-2015 & PMRP-2004. It is important that these already approved transmission elements along with capacitors for reactive power support are commissioned at the earliest to improve the transmission network in J&K control area.
- A.8.14** NRLDC & NRPC representatives stated that the transmission lines along with schemes being implemented by J&K may be included in follow-up agenda of OCC meeting and then update may be sought in monthly OCC meetings.
- A.8.15** Further, in a meeting organized by CEA on 04.10.2023 to deliberate the issue of Charging of 220 kV Wagoora- Zainakote Transmission line after re-conductoring, J&K was asked to remove the tapping of 220kV Wagoora-Ziankote line and NRPC/OCC was asked to follow up the same at RPC level. Minutes of meeting are attached as **Annexure-VII**. Extract of MoM of the meeting are quoted below:
- “JKPTCL was requested to complete the 2nd D/c line between Wagoora- Zainakote with LILO at Budgam, at the earliest and subsequently remove the tapping of existing circuit at Budgam at the earliest.”*
- “NRPC to be apprised about the issue, so that the same could be deliberated in NRPC/OCC forum so as to ensure that the tapping is removed at the earliest.”*
- A.8.16** J&K representative stated that land acquisition is in progress for one pending tower location & it is expected that the line would be charged very soon.
- A.8.17** MS NRPC stated that the line may also be included in list of follow up agenda of OCC meeting.

### **Decision of Forum**

I/34026/2024

71<sup>st</sup> NRPC Meeting (29<sup>th</sup> January 2024)–MOM

1. Forum expressed concerns on low voltage profile in J&K and requested them to expedite the actions to improve the voltage profile.
2. Transmission lines along with schemes being implemented by J&K may be included in follow-up agenda of OCC meeting.

## **A.9 Implementation of islanding schemes in Agra (agenda by UPSLDC)**

- A.9.1 EE (P), NRPC apprised that islanding scheme progress status was discussed in the 70<sup>th</sup> NRPC meeting wherein observations from LPGCL on the CPRI report were deliberated.
- A.9.2 LPGCL raised its concern on procedure of revival from islanding to normal state.
- A.9.3 Subsequently, it was gathered that both parties can discuss the observations separately.
- A.9.4 In view of above, a special meeting was held on 30.11.2023 in UPSLDC, later a meeting on subject issue was held on 19.12.2023 in the office of Managing Director, UPPTCL. Record proceedings of the meeting is attached as **Annexure- VIII**.
- A.9.5 In the meeting held on 19.12.2023, it was decided that the final report (**Annexure-IX**) of Agra Islanding Scheme submitted by M/s CPRI shall be put up in next NRPC meeting for approval and implementation.
- A.9.6 Meanwhile, the matter was discussed in the 215<sup>th</sup> OCC meeting held on 12.01.2024 and scheme was approved and recommended for further approval from NRPC forum.
- A.9.7 In the 71<sup>st</sup> NRPC meeting, LPGCL representative agreed for implementation of islanding scheme however, he raised following points:
- I. Over frequency Instantaneous tripping cannot be set at 55HZ as this 55HZ frequency is the back-up protection for turbine.
  - II. Islanding shall not happen for the cases 3,4,7,15 &18 as the Islanded load is substantially more than the generation and due to inherent slow response of the boiler (MOM dated 19.12.2023) the generation and load balance cannot be maintained. If Islanding happens in these cases, then running units at LPGCL will be isolated from grid (due to tripping of EHV breakers at 47.5Hz, 3 sec delay) and will be islanded with 15MW aux load and will not sustain and finally will trip on under frequency protection of 47.5Hz, 5sec delay.
  - III. The boiler response time has not been considered in the Islanding study done by CPRI, Bangalore.

I/34026/2024

71<sup>st</sup> NRPC Meeting (29<sup>th</sup> January 2024)–MOM

- IV. The schemes/logics/settings to be done in the relays at both Fatehabad/Agra end and LPGCL end are to be sent to LPGCL for review and comments, if any.
- V. While making the settings in Islanding implementation, the safety, protection and reliability of Turbo Generator at LPGCL end shall be ensured, as recommended by OEM.

- A.9.8 Further, LPGCL representative asked final study report of CPRI so that logic for island can be discussed.
- A.9.9 UPSLDC representative conveyed that logic is available in the CPRI report itself. He added that UFR at some substations and over frequency generator tripping relays are to be installed in line with CPRI report.
- A.9.10 MS, NRPC requested UPSLDC to address the issues of LPGCL and implement the islanding scheme.

**Decision of Forum**

*Forum approved in-principally Agra islanding scheme for implementation and requested UPSLDC to address the issues of LPGCL.*

**A.10 Retaining of spare 500 MVA ICT at 400 kV Nakodar which was allocated by PGCIL as regional spare on returnable basis (agenda by PSTCL)**

- A.10.1 PSTCL representative apprised that 1 No. 315 MVA, 400/220/33 kV siemens make ICT had got defective at 400 kV substation Nakodar on 06.02.2023. The ICT had been sent to the premises of M/S Siemens for repair.
- A.10.2 In view of the critical loading conditions at 400 kV Nakodar, PSTCL had requested NRPC to allocate 1 No. 500 MVA ICT (regional spare meant for Northern Region States) from PGCIL. NRPC in its 63rd meeting held on 24.02.2023 had allocated 1 No. 500 MVA ICT (regional spare from PGCIL) to Punjab.
- A.10.3 Thereafter PGCIL, upon various internal approvals of their own, had subsequently allocated the spare ICT from their 400 kV substation Barwala (Panchkula).
- A.10.4 Further he added that the ICT was allocated to Punjab on RETURNABLE basis, meaning that PSTCL shall have to return the ICT to PGCIL, but PSTCL has incurred about Rs. 1 crore on dismantlement, loading, packaging, unloading and transportation of above-mentioned 500 MVA ICT from 400 kV substation PGCIL, Panchkula to 400 kV substation PSTCL, Nakodar.

I/34026/2024

71<sup>st</sup> NRPC Meeting (29<sup>th</sup> January 2024)–MOM

- A.10.5 Similar expenditure will be incurred while returning the ICT to PGCIL. Apart from this, ICT will be subjected to wear and tear.
- A.10.6 It is evident from the above that the whole process of dismantlement/transportation/energization of spare ICT from 400 kV substation Barwala (PGCIL) to 400 kV substation Nakodar (PSTCL) involved significant amount of expenditure and time. Had the spare ICT been allocated from a distant location (instead of Barwala/Panchkula), more clearances from Railways/bridges department along with extra time & higher expenditure would have been involved.
- A.10.7 In view of the above, he proposed that instead of returning the spare ICT back to PGCIL, it may be retained by PSTCL at 400 kV Nakodar and PSTCL will reimburse the cost of the ICT.
- A.10.8 POWERGRID representative highlighted that POWERGRID has already given total 7 nos. of ICT for different utilities in Northern region on loan basis and if the same are not returned in allocated time, it will hamper POWERGRID's reliability and availability.
- A.10.9 PSTCL representative proposed POWERGRID to take 500MVA ICT of PSTCL if required.
- A.10.10 PSTCL representative informed that spare ICT of POWERGRID was allocated to them in April, 2023 for one year. Meanwhile damaged 315MVA ICT of PSTCL is under repairing process and will be available for service in October, 2024.
- A.10.11 MS, NRPC suggested PSTCL that they would have discussed the issue with POWERGRID earlier before discussing the same in NRPC forum.

***Decision of Forum***

*Forum suggested POWERGRID and PSTCL to discuss the matter bilaterally and resolve the same.*

**A.11 Construction of 220/132 kV, 2X100 MVA Substation nearby Una and 220 kV (Twin Zebra) D/C line from 220/132 kV Nehrian Substation to proposed 220/132 kV, 2X100 MVA Substation near Una (agenda by HPPTCL)**

- A.11.1 HPPTCL representative apprised that the power supply in Una Distt. is being catered through following system-

I/34026/2024

71<sup>st</sup> NRPC Meeting (29<sup>th</sup> January 2024)–MOM

- I. 220/132 kV,200 MVA Nehrain Substation by D/C LILO of 220 kV Hamirpur Jalandhar line.
- II. 132 kV D/C line from Nehrian to 132/33 kV Amb Substation
- III. 132 kV S/C line from Amb to 132/33 kV Rakkar Substation
- IV. 132 kV S/C line on D/C towers from Rakkar to 132/33 kV Tahliwal Substation

- A.11.2 Una Distt. has four important industrial areas namely Una (Mehatpur), Tahliwal, Amb & Gagret. Currently Una & Tahliwal area has peak load requirement of around 100 MVA and Amb and Gagret substation are also feeding around 90 MVA load.
- A.11.3 The above load requirement is being fed from 220/132 kV, 200 MVA Nehrian Substation which is constructed by D/C LILO of 220 kV Jalandhar to Hamirpur (Single Zebra) line of PGCIL. Further the power is supplied by 132 kV D/C Nehrian-Amb line and thereafter through 132 kV S/C line from Amb to Una.
- A.11.4 Presently, in case of fault on 132 kV Amb to Una line, the industrial area along with domestic consumers have to face power disruptions as there is no alternate supply to the area. Further the 132 kV S/C line from Amb to Una (Rakkar) is being used to its full capacity.
- A.11.5 Apart from the above Hon'ble Prime Minister has recently laid the foundation stone of Bulk Drug Pharma Park in Polian Beet area of Distt Una. There is additional load requirement of around 120 MVA which needs to be met progressively.
- A.11.6 As an immediate measure HPPTCL is constructing 220/132 kV, 80/100 MVA Substation at Tahliwal (Distt. Una in Himachal Pradesh) by S/C LILO of 220 kV D/C Bhakra Jamalpur D/C line of BBMB with Provision of SPS to restrict drawl at 50 MVA and to ensure no drawl of Power from Jamalpur side in case of outage of Bhakhra - Tahliwal circuit in line with approval of Power Subcommittee of BBMB and 69<sup>th</sup> NRPC.
- A.11.7 Therefore, considering above and lack of any other source of power nearby, HPPTCL has planned construction of 220 kV (Twin Zebra) D/C line from 220/132 kV Nehrian Substation to proposed 220/132 kV Substation near Una & 220/132 kV, 2X100 MVA Substation nearby Una. (Proposed Connectivity Diagram attached at **Annexure- X**).
- A.11.8 As a result, N-1 compliant system shall be available to both existing domestic and industrial consumers as well as proposed Bulk Drug Pharma Project and future industries since the area is important industrial area of the state. HPPTCL has also granted connectivity to solar projects of around 103 MW. Further feasibility has been sought by additional Solar Projects of around 350 MW.

I/34026/2024

71<sup>st</sup> NRPC Meeting (29<sup>th</sup> January 2024)–MOM

- A.11.9 He conveyed that the proposed system was discussed in meeting held under chairmanship of Chief Engineer PSPA CEA on meeting dated- 02.11.2023 along with CTUIL & GRID INDIA. After deliberations, the proposal of HPPTCL for establishment of 220/132 kV, 200 MVA substation nearby Una, Himachal Pradesh, through Una (New) – Nehrian 220 kV D/c line under intrastate transmission system was agreed. Further, with the implementation of above intra-state system, the loadings of 400/220 kV ICTs at Jalandhar (PG), and 220 kV Nehrian - Hamirpur D/c line need to be observed with the progressive increase in demand in Una area so that suitable augmentation measures in ISTS may be planned accordingly, if required. (MoM attached as **Annexure- XI**).
- A.11.10 GM, NRLDC submitted that there is need for tracking the load pattern of Jalandhar ICT. In future as industrial load will come of drug pharma, then loading will increase on the same. These comments have already been given as feedback during discussion in the mentioned meeting with CEA.
- A.11.11 MS, NRPC also conveyed that as per approval of CEA, the proposal of HPPCTL may be approved.

**Decision of Forum**

*Forum accorded the proposal for Construction of 220/132 kV, 2X100 MVA Substation nearby Una and 220 kV (Twin Zebra) D/C line from 220/132 kV Nehrian Substation to proposed 220/132 kV, 2X100 MVA Substation near Una in line with discussion held on 02.11.2023 with CEA.*

**A.12 Mandatory Testing and Certification of Telecom Equipment (MTCTE) (agenda by NRPC Secretariat)**

- A.12.1 EE (P) apprised that Indian Telegraph (Amendment) Rules vide Gazette Notification No G.S.R. 1131(E) dated 5<sup>th</sup> September 2017 on 'Testing and Certification of Telegraph' mandates that any telegraph (telecom) equipment which is used or capable of being used with Indian telecom network shall have to undergo prior Mandatory Testing & Certification in respect of parameters as determined by the telegraph authority from time to time.

I/34026/2024

71<sup>st</sup> NRPC Meeting (29<sup>th</sup> January 2024)–MOM

- A.12.2 Telecommunication Engineering Centre (TEC), the technical body under Department of Telecommunications (DoT) is administrating the implementation of Mandatory Testing & Certification of Telecom Equipment (MTCTE) Scheme.
- A.12.3 As on date, MTCTE certificate is mandatory for Telecom & Networking product such as Cordless/CLIP/Landline Phone, PABX, FTTH OLT/ONT/ONU used for broadband services etc. prior to their sale/use in India.
- A.12.4 Further, MTCTE Certificate will become mandatory from 01.04.2024 for 12 products being connected to Telecom Network/used for data transfer (such as Router, LAN Switch, Smart Electricity Meters etc.)
- A.12.5 For remaining 32 products, certification will be mandatory from 01.01.2024.
- A.12.6 In view of above, it is to be ensured that only MTCTE certified Telecom & Networking products are procured and connected in the Indian Telecom Network as mandated by Indian Telegraph (Amendment) Rules, 2017.
- A.12.7 In this regard, letter from Department of Telecommunication, Ministry of Communication and Ministry of Power are attached as **Annexure-XII** for reference along with enclosures having details of aforesaid equipment.
- A.12.8 SE (C), NRPC recommended that compliance of the same may be cross verified by auditing.
- A.12.9 POWERGRID representative highlighted that POWERGRID has already adopted the above direction since issuance and taking care of communication aspects.
- A.12.10 CTU representative stated that CTU will include this MTCTE compliance in RFP documents.
- A.12.11 MS, NRPC emphasized that all state should take care of compliance of MTCTE.
- A.12.12 UP STU representative ensured that the certification and procurement wing will be updated about the same.

### ***Decision of Forum***

*Forum acknowledged the Mandatory Testing & Certification of Telecom Equipment (MTCTE) Scheme and all utilities were directed for compliance.*

### **A.13 Capacity Building Programme for Northern Regional Constituents through PSDF fund (agenda by NRPC Secretariat)**

I/34026/2024

71<sup>st</sup> NRPC Meeting (29<sup>th</sup> January 2024)–MOM

- A.13.1 EE (P), NRPC apprised that the agenda was discussed in the 70<sup>th</sup> NRPC meeting held on 18.11.2023 wherein draft of DPR for PSDF fund was put up for approval of forum.
- A.13.2 After detailed discussion, forum agreed in-principally on training proposal and decided that proposed DPR may be modified in discussion with POWERGRID (implementing agency) and ASCI (training agency) for including latest technology as part of training.
- A.13.3 Accordingly, a meeting with POWERGRID and ASCI was held on 16.01.2024 under chairmanship of MS, NRPC to explore the horizons of training module in line with suggestions of forum. In the meeting, ASCI highlighted that training module is having new technologies such as Hydrogen Fuel, EV, Low Carbon Emission etc.
- A.13.4 MS, NRPC conveyed that first batch is likely to go in June, 2024. Therefore, there is less time available as approval for PSDF grant is to be done.
- A.13.5 Accordingly, proposed draft DPR for PSDF grant attached as **Annexure-XIII** was put up for approval of forum.

#### **Decision of Forum**

*Forum approved the DPR and recommended for availing grant under PSDF.*

#### **A.14 Outstanding Contribution to NRPC fund (agenda by NRPC Secretariat)**

- A.14.1 EE (P), NRPC apprised that Demand Letter for contribution towards NRPC fund for the year 2023-24 was sent on 31.08.2023 to all the constituent members. It was also mentioned that beyond 31<sup>st</sup> October 2023, 1 % simple interest shall be levied. Accordingly, NRPC Secretariat has received contributions from organizations.
- A.14.2 However, some organisations have made payment after 31<sup>st</sup> October but have not paid penalty amount. Details of organisations along with date of payment is mentioned below:

S. No.	Name of Constituent	Period (FY)	Contribution amount Paid	Payment Date	Penalty Pending (Rs)
1	HPSEB	2023-24	10,00,000	03.11.2023	10000
2	NTPC	2023-24	10,00,000	07.11.2023	10000
3	UJVNL	2023-24	10,00,000	17.11.2023	10000



I/34026/2024

71<sup>st</sup> NRPC Meeting (29<sup>th</sup> January 2024)–MOM

4	UT of Ladakh	2023-24	10,00,000	05.12.2023	20000
5	JVVNL	2023-24	10,00,000	06.12.2023	20000
6	Lanco Anpara Private Limited	2023-24	10,00,000	08.12.2023	-
7	Renew Power	2023-24	10,00,000	14.12.2023	20000
<b>Grand Total</b>					<b>90,000</b>

A.14.3 He added that recently, CAG audited at NRPC and observed the pending interest amount of constituents towards NRPC contribution fund. The same is attached as **Annexure- XIV**.

A.14.4 He conveyed that as per information from NTPC, they did not get the demand letter due to communication gap. Lanco Anpara Private Limited has informed NRPC Secretariat that due to management change, there was delay in receipt of demand letter. It requested for revised demand letter and accordingly revised demand letter with due date of 15.12.2023 was sent from NRPC Secretariat.

A.14.5 Further, it is also to mention that UT of J&K and MVVNL have not paid the contribution amount till date. Details of pending amount along with applicable penalty is mentioned below:

S. No.	Name of Constituent	Period (FY)	Contribution amount	Penalty (Rs)	Total Outstanding amount
1	Madhyanchal Vidyut Vitaran Nigam Ltd.	2023-24	10,00,000	30000	10,30,000
2	UT of J&K	2023-24	10,00,000	30000	10,30,000

A.14.6 JKPCCL informed that they will send concerned officer to reconcile the contribution amount paid to NRPC. Further, he said that demand letter for FY 2020-21 and for FY 2023-24 has not been received till now. He requested to send demand letter to CE, JKPCCL.

A.14.7 During meeting itself, SE(C), NRPC sent the mail to CE, JKPCCL on mail id provided by him.

A.14.8 There was no representative from Madhyanchal Vidyut Vitaran Nigam Ltd. in the meeting.

A.14.9 SE, UP STU stated that he will send a letter to Madhyanchal Vidyut Vitaran Nigam Ltd. for paying the contribution amount to NRPC secretariat in line with the discussion held in the 71<sup>st</sup> NRPC meeting.

I/34026/2024

71<sup>st</sup> NRPC Meeting (29<sup>th</sup> January 2024)–MOM**Decision of Forum**

*Forum requested concerned utilities to expedite the payment process of contribution (and penalty, if any) towards NRPC fund.*

**A.15 Outstanding Contribution from constituent member J&K (agenda by NRPC Secretariat)**

- A.15.1 EE (P), NRPC apprised NRPC Secretariat has been receiving contribution from most of the constituents in a timely manner except few members. Since FY 2021-22, there has also been provision of penalty of 1% simple interest per month on late payment as decided in NRPC meeting.
- A.15.2 It is informed that till JKPDC and JKPD have pending membership payments of 32 lakhs and 22.5 lakhs respectively, details of which are mentioned below:

S. No.	Name of Constituent	Period (FY)	Outstanding amount (Rs.)	Penalty (Rs)	Total outstanding amount (Rs.)
1	J&K State Power Development Corp. Ltd.	2014-15	11,00,000	-	11,00,000
2		2015-16	11,00,000	-	11,00,000
3		2018-19	10,00,000	-	10,00,000
4	J&K State Power Development Department	2019-20	10,00,000	-	10,00,000
5		2021-22	10,00,000	2,50,000	12,50,000
<b>Grand Total</b>					<b>54,50,000</b>

- A.15.3 In this regard, pending payment status was discussed in various meetings and several reminders and D.O. letters have also been communicated by NRPC Secretariat (copy enclosed as **Annexure-XV**), however above payment is pending till date.
- A.15.4 He added that CAG in its audit of NRPC fund, has also raised concern over late and delayed payments to NRPC fund for the past Financial Years. It has mentioned that this is resulting in loss of recurring interest.
- A.15.5 MS, NRPC suggested to discuss the same in the next NRPC meeting. Meanwhile JKPC may send their representative along with supporting documents to reconcile the paid contribution to NRPC fund as claimed for FY 2020-21 by 10.02.2024.

**Decision of Forum**

*The agenda was deferred for discussion in the next NRPC meeting.*

I/34026/2024

71<sup>st</sup> NRPC Meeting (29<sup>th</sup> January 2024)–MOM

**A.16 Approval of finalized protection philosophy for Northern Region (agenda by NRPC Secretariat)**

- A.16.1 EE (P) apprised that after detailed deliberation in 49<sup>th</sup> Protection Sub- Committee meeting, protection philosophy for Northern Region was finalized. The same is put up for approval of NRPC forum. (Attached as **Annexure-XVI**)
- A.16.2 MS, NRPC recommended that forum may approve the same in line with the decision of 49<sup>th</sup> Protection Sub- Committee meeting.

***Decision of Forum***

*Forum approved the finalized protection philosophy for Northern Region attached as Annexure- XVI. All utilities were requested for compliance.*

**A.17 Issue of FTC for balance 765kV Bays (701, 702, 703, 705, 706) and Spare Reactor & ICT units w.r.t. M/s PMSTL at 765/400/220KV GIS Meerut substation (agenda by POWERGRID)**

- A.17.1 POWERGRID representative apprised that there is issue of First Time Charging (FTC) of 765kV Future bays, spare unit of 765kV ICT & spare unit of 765kV Bus Reactor due to discrepancies in standing committee approval for 765/400/220 kV GIS Meerut under PMSTL.
- A.17.2 765/400/220kV Meerut GIS has been constructed by POWERGRID Meerut Simbhavali Transmission Limited (PMSTL) & following 765kV elements at 765/400/220kV GIS has been successfully commissioned:
- I. 3x500 MVA, 765/400/33 kV ICT-1 (Bay 707)
  - II. 3x500 MVA, 765/400/33 kV ICT-2 (Bay 704)
  - III. 3x80 MVAR, 765 kV Bus Reactor (Bay 712)
  - IV. 765 kV Meerut-Hapur Line (Bay 710)
  - V. 765 kV Meerut-Gr. Noida Line (Bay 709)
  - VI. 765 kV Tie Bay 708 & 711
  - VII. 765 kV Bus-I & Bus-II

I/34026/2024

71<sup>st</sup> NRPC Meeting (29<sup>th</sup> January 2024)–MOM

A.17.3 He mentioned that FTC for following elements have not been issued by SLDC/UPPTCL stating that Standing committee approval for these future elements & associated bays is not in place. Various correspondences have been made by PMSTL with M/s UPPTCL on the subject matter:

- I. Bay 701 (ICT-3 Future)
- II. Bay 702 (Tie Bay of ICT-3 Future and Future Line-2),
- III. Bay 703 (Future Line-2),
- IV. Bay 705 (Tie Bay of ICT-2 and Future Line-I),
- V. Bay 706 (Future Line-I),
- VI. Spare unit of 765 kV ICT,
- VII. Spare unit of 765kV Bus Reactor

A.17.4 He further submitted that the scope of the project is mentioned in RFP documents. The same scope was mentioned in the letter dated 06 March'2019 from UPPTCL appointing PFCCCL as BPC inter-alia informing scope of project-Meerut Simbhavali prior to floating of TBCB tender by the BPC (NIT for the Project was released on 17 June 2019). Furthermore, the same scope of work is contained in the TSA which is signed between TSP and LTTCs. The relevant pages of RFP document and a copy of aforementioned letter from UPPTCL are enclosed at **Annexure-XVII**.

A.17.5 Following documents has been submitted to SLDC wherein detailed scope of work including Future bays/elements is mentioned but SLDC as per remarks of NRLDC requires Standing committee approval:

- I. Minutes of the 22nd meeting of the 13th plan period of "Transmission Work Approval Committee" constituted by U.P. Power Transmission Corporation Ltd convened on 09.01.2019 Issued through letter no. 3739 – Superintendent/T.P.E. P.S.M./13V. Scheme/TWC Dated: 14.01.2019.
- II. Section 68 permission vide Letter ref no. 1167/ 24-1-2019-450 /2019, dated 14.08.2019 from Chief Secretary, UP Govt for scheme agreed.
- III. Transmission Service Agreement of PMSTL. Relevant documents quoted above are attached as **Annexure-XVIII**.

I/34026/2024

71<sup>st</sup> NRPC Meeting (29<sup>th</sup> January 2024)–MOM

- A.17.6 He informed that the issue regarding issue of FTCs for balance 765 kV Bays (701, 702, 703, 705, 706) and Spare Reactor & ICT units was discussed in 67<sup>th</sup> NRPC and 214<sup>th</sup> OCC meeting, wherein M/s UPPTCL was advised to take up the matter with Chief Engineer, PSPA Division, CEA for resolution of the issue.
- A.17.7 On dt. 05.01.2024, Director, UPPTCL has requested NRLDC to issue charging code for aforesaid said. NRLDC is yet to issue the same.
- A.17.8 POWERGRID representative further addressed that they are facing operational issues in absence of Spare unit of 765 kV ICT and 765kV Bus Reactor if there is fault in the commissioned units. Along with this, there are pending amount of around 100 crores as bills of PMSTL are being returned by UPPTCL due to non-declaration of COD. No payment is released till date.
- A.17.9 Due to financial issues, it has become quite difficult to do O&M activities by POWERGRID.
- A.17.10 POWERGRID requested UPPTCL/SLDC to declare COD and release bills of PMTSL. Further, NRLDC may be requested to go ahead for the FTC for remaining bays and elements.
- A.17.11 UPPTCL representative informed forum that they have already sent a letter to CEA on 15.01.2024 about the bays, after the discussion held in the 215<sup>th</sup> OCC meeting.
- A.17.12 GM, NRLDC ensured to take up the matter after discussion with PSPA division, CEA.
- A.17.13 MS, NRPC conveyed UPSLDC to clear the issues of COD declaration and UPPTCL may take up the matter with Director (W &P) of UPPTCL for settlement of commercial issues of POWERGRID.

### ***Decision of Forum***

1. Forum requested UPPTCL to clear the bills of PMSTL/POWERGRID and settle the commercial issues for approved asset of PMTSL/POWERGRID at the earliest.
2. NRLDC was requested to go ahead for the FTC for remaining bays and elements.

- A.18 Imposition of shutdown charges by Rajasthan Rajya Vidyut Prasaran Nigam Limited, Jaisalmer of their transmission lines for construction activities by POWERGRID, contrary to CERC Regulation (agenda by POWERGRID)**

I/34026/2024

71<sup>st</sup> NRPC Meeting (29<sup>th</sup> January 2024)–MOM

A.18.1 POWERGRID representative apprised that the RRVPNL has requested POWERGRID to deposit shutdown charges for shutdown of transmission lines being availed by POWERGRID, which is contrary to CERC regulation 2019-24. The relevant point no. 4 of Appendix-II of CERC regulation-II is reproduced as under:

*“The transmission elements under outage due to following reasons shall be deemed to be available:*

- i. Shut down availed for maintenance of another transmission scheme or construction of new element or renovation/upgradation/additional capitalization in existing system approved by the Commission. If the other transmission scheme belongs to the transmission licensee, the Member-139 Secretary, RPC may restrict the deemed availability period to that considered reasonable by him for the work involved. In case of dispute regarding deemed availability, the matter may be referred to Chairperson, CEA within 30 days.*
- ii. Switching off of a transmission line to restrict over voltage and manual tripping of switched reactors as per the directions of concerned RLDC.”*

A.18.2 He added that this issue was discussed in 214th OCC meeting as table agenda, wherein M/s RRVPNL was requested to look into matter. RRVPNL replied that not imposition of shutdown charges does not fit for POWERGRID subsidiaries.

A.18.3 POWERGRID representative highlighted that a subsidiary funded totally (100 percentage) by POWERGRID should not be treated differently.

A.18.4 SE, RVPNL recommended forum to consider that shutdown charges should not be levied on TBCB projects of RVPNL by POWERGRID against Rajasthan as if POWERGRID is demanding for not levying shutdown charges for their TBCB projects in Rajasthan.

A.18.5 POWERGRID representative agreed on this proposal of RVPNL for not levying shutdown charges on TBCB projects of Rajasthan against them because CERC regulation mandates such shutdown to be considered as deemed available.

A.18.6 GM, NRLDC submitted that there is need to go in detailing of it along with regulations.

A.18.7 SE, RVPNL conveyed that they will look into the matter again for further direction.

A.18.8 Further, POWERGRID representative requested forum to arrange shutdown approval from RVPNL for applied outages by POWERGRID for the construction activities.

I/34026/2024

71<sup>st</sup> NRPC Meeting (29<sup>th</sup> January 2024)–MOM

- A.18.9 POWERGRID representative informed that shutdown of Debari- RAPP B line is required for stringing work of Neemach- Chittorgarh D/C. The aforesaid shutdown was approved in the last two OCC meetings, but the same has not been granted for POWERGRID till now.
- A.18.10 EE, SLDC (Rajasthan) highlighted that due to loading issues, the shutdown was not granted.
- A.18.11 POWERGRID representative informed that internally they have discussed with CE, Rajasthan DISCOM on load issue during shutdown. But it has been agreed by him to allow the shutdown on coming Sunday.
- A.18.12 MS, NRPC conveyed Rajasthan SLDC and RVPNL to give shutdown of 2 days to POWERGRID subject to real time Grid condition and issues of shutdown charges may be settled later. NRLDC was also directed to look into the same to facilitate shutdown.

#### **Decision of forum**

1. *Forum decided that matter of levying shutdown charges on outages for construction activities of TBCB projects will be discussed in the next OCC (216<sup>th</sup>) meeting likely to be held in mid of February, 2024.*
2. *Rajasthan SLDC and RVPNL may allow shutdown for POWERGRID subject to real time grid condition.*

#### **A.19 Replacement of existing 420kV 50MVAR Bus Reactors at Mandola & Muradnagar substation with 125MVar bus reactor (agenda by POWERGRID)**

- A.19.1 POWERGRID representative apprised that 400/220kV Mandola substation in NR-I was commissioned in 1990 and 50MVAR Bus reactor (BHEL make, 3-phase) on this substation was commissioned in 1991. Due to ageing of reactor, frequent leakages have been observed despite all preventive measures/overhauling of the reactor. The furan value of the reactor is also in increasing trend and present value is 2.4PPM. As reactor has already completed more than 32 years of service life and any major maintenance may not be enough to ensure further reliable & longer service period.
- A.19.2 Apart from the above, 01 no. 420kV, 50MVAR Bus reactor (3x16.67 MVAR, CGL make 1 phase unit, DOCO - 1988) was commissioned at Muradnagar substation of UPPTCL (owned by POWERGRID). Frequent oil leakages and deteriorated oil parameters along with high vibrations have been observed in these units. This reactor is also not reliable

I/34026/2024

71<sup>st</sup> NRPC Meeting (29<sup>th</sup> January 2024)–MOM

and is vulnerable to fail due to its ageing. Further any major maintenance may not be enough to ensure further reliable & longer service period. As the system fault level at both the substations have increased over a period of time (more than 30 years), therefore bus reactors of 50 MVAR may not be adequate at both stations (Mandola & Muradnagar). POWERGRID requested to review the augmentation of above said bus reactors for better voltage regulation.

- A.19.3 Further, he added that in Grid India operational feedback report FY 2022-23(Q3) also, it was mentioned that voltage at 400kV Mandola remains more than 420kV for 9-18% of time and 415kV and above for about 40% of time. Similarly, from operational feedback report FY 2022-23(Q4) it emerged that voltage at 400kV Muradnagar remains more than 420kV for 18-22% of time and 415kV and above for about 40% of time.

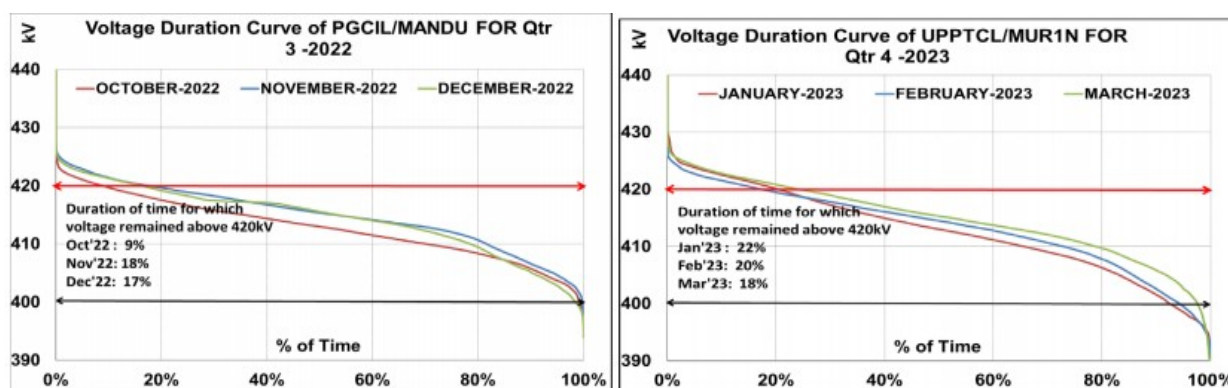

Voltage duration curve of 400kV Mandola & Muradnagar for 2022-23 (Source: Grid-India)

- A.19.4 He highlighted that from Grid-India operational feedback & prevailing high voltage scenario in NR, 50MVAR bus reactor each at Mandola (PG) & Muradnagar (UPPTCL) may be replaced with 125MVAR (420kV) bus reactor.
- A.19.5 Subsequently, the subject issue was discussed & agreed technically in 27<sup>th</sup> CMETS-NR meeting held on 10.01.2024.
- A.19.6 MS, NRPC observed that work has already been agreed upon in the 27th CMETS-NR meeting.
- A.19.7 POWERGRID requested NRPC forum to approve its proposal for executing the work under Additional Capitalization in Tariff Block 2024-2029.

**Decision of forum:**

*Forum approved proposal of POWERGRID to replace the existing 420kV 50MVAR Bus Reactors at Mandola & Muradnagar substation with 125MVAR bus reactor under Additional Capitalization in Tariff Block 2024-2029.*



I/34026/2024

71<sup>st</sup> NRPC Meeting (29<sup>th</sup> January 2024)–MOM

**A.20 Scheme to relieve high loading of WR-NR Inter Regional Corridor (400 kV Bhinmal-Zerda line) (agenda by POWERGRID)**

**A.20.1** POWERGRID representative apprised that a scheme to relieve high loading of WR-NR Inter- Regional Corridor was approved in 9<sup>th</sup> Meeting of NCT on dated 28<sup>th</sup> September 2022, where following arrangement were finalized:

- I. Bypassing of 400kV Kankroli-Bhinmal-Zerda line at Bhinmal to form 400 kV Kankroli – Zerda (direct) line (with necessary arrangement for bypassing Kankroli- Zerda line at Bhinmal with suitable switching equipment inside the Bhinmal substation).
- II. Reconductoring of 400 kV Jodhpur (Surpura)(RVPN) – Kankroli S/c (twin moose) line with twin HTLS conductor.
- III. OPGW installation on 400 kV Jodhpur (Surpura)(RVPN) – Kankroli S/c (twin moose) line -188 km

**A.20.2** Further, He informed that vide letter dt. 15.11.2022, CEA has advised POWERGRID to carry out the aforesaid works on priority. Accordingly, POWERGRID, took these works on top priority and current status are as follows:

Sl. No.	Description	Status
i)	Bypassing of 400kV Kankroli-Bhinmal-Zerda line at Bhinmal to form 400 kV Kankroli – Zerda (direct) line (with necessary arrangement for bypassing Kankroli- Zerda line at Bhinmal with suitable switching equipment inside the Bhinmal substation).	For installation of switching equipment at Bhinmal, POWERGRID placed a work order on dt. 01 <sup>st</sup> March'2023 on M/s Apar with completion schedule of 8 months from placement of LOA.  For the subject work, shutdown of 400KV Kankroli – Bhinmal – Zerda line is required for approx. 4-5 months on continues basis.  To strengthen the interconnection grid from NR to WR, a temporary bypassing of 400kV Bhinmal-Zerda & 400kV Bhinmal-Kankroli Line through jumper at LILO point was proposed during physical execution of

I/34026/2024

71<sup>st</sup> NRPC Meeting (29<sup>th</sup> January 2024)–MOM

		<p>project.</p> <p>The subject proposal was discussed with 209<sup>th</sup> &amp; 215<sup>th</sup> OCC shutdown meeting as well and was agreed upon.</p> <p>However, NRLDC has requested POWERGRID for approval of this interim arrangement in standing committee.</p>
ii)	Reconductoring of 400 kV Jodhpur (Surpura)(RVPN) – Kankroli S/c (twin moose) line with twin HTLS conductor	The work under advance stage of execution and likely to be completed by 15 <sup>th</sup> February'2024.
iii)	OPGW installation on 400 kV Jodhpur (Surpura)(RVPN) – Kankroli S/c (twin moose) line	The work under advance stage of execution and likely to be completed by 15 <sup>th</sup> February'2024.

**A.20.3** CGM, NRLDC highlighted that the aforesaid line is Interregional line, therefore consent of NLDC and WRLDC is required to be taken for implementation of proposed interim arrangement.

**A.20.4** POWERGRID representative informed that foundation of by-pass isolator has been done in switchyard and complete arrangement including installation of switching equipment will be done in next 3 months.

**A.20.5** GM, NRLDC suggested to have a separate discussion on finalization of interim arrangement along with WRLDC, NRPC, WRPC, CEA, CTU, POWERGRID and Rajasthan SLDC.

***Decision of forum***

*Forum decided to discuss the proposed interim arrangement separately with NRLDC, WRLDC, NRPC, WRPC, CEA, CTU, POWERGRID and Rajasthan SLDC.*

**A.21 Tapping arrangement for LILO of one ckt.(CKT-II) of existing 400KV D/C Ludhiana-Koldam line at proposed 400KV Substation Ropar (agenda by PSTCL)**

A.21.1 PSTCL representative apprised that the work of construction of 400KV Line i.e LILO of 400KV Ludhiana-Koldam line (CKT-II) at 400KV Ropar is in full swing. 400KV D/C

I/34026/2024

71<sup>st</sup> NRPC Meeting (29<sup>th</sup> January 2024)–MOM

Ludhiana-Koldam Transmission line is being operated by JV of PGCIL and PKTCL (Parbati koldam Transmission Company limited, PKTCL).

- A.21.2 PSTCL has requested PKTCL vide letter memo no. 2200 dated 14.09.2023 (**Annexure-XIX A**) to accord the necessary approval for tapping arrangement at tapping tower no.161 of the 400KV Ludhiana- Koldam Line. However, PKTCL vide their letter dated 16.12.2023 (**Annexure-XIX B**) has responded that:

*CEA (Measures relating to safety and Electricity Supply) Regulation, 2023, Regulation 46(4) restricts tapping of transmission of voltage level 66KV & above. Citation of same is given below:-*

*“There shall not be tapping of another transmission line from the main line for 66 KV and above class of line: Provided that during natural calamities, tapping may be allowed to ensure emergency power supply to affected areas till normalcy restored.”*

*In view of this, following is proposed:-*

*Loop- in should be done through tower no.159 & Loop-out should be done through tower no.161 of existing 400KV D/C Ludhiana-Koldam Transmission Line (CKT-II). The Span of either side of PSTCL Tower No.1 shall be more than 400 Meters. If required, additional tower must be provided between existing Tower no.159/161of PKTCL & Tower no.1 of PSTCL for maintenance of adequate ground clearance and live metal clearances.*

- A.21.3 In this regard he apprised that the CEA (Measures relating to safety and Electricity Supply) Regulation, 2023(**Annexure-XIX C**) is an updation to CEA (Measures relating to safety and Electricity Supply) Regulation, 2010(**Annexure-XIX D**), wherein, guidelines for tapping arrangement is unchanged i.e guidelines for tapping arrangement in CEA (Measures relating to safety and Electricity Supply) Regulation, 2010 & CEA (Measures relating to safety and Electricity Supply) Regulation, 2023 are same.
- A.21.4 He conveyed that recently, in case of the LILO of 400 KV Jalandhar-Kurukshetra (PGCIL) line at 400 KV Dhanansu (PSTCL), PGCIL has given the approval for tapping arrangement in the same pattern vide their letter no. N2MLK/TL/PSTCL/2021/95 dated 25.10.2021(**Annexure-XIX E**).

I/34026/2024

71<sup>st</sup> NRPC Meeting (29<sup>th</sup> January 2024)–MOM

- A.21.5 He informed about the Maximum span for the design configuration of towers of PSTCL is 375 m therefore, it cannot be used for more that 400m span.
- A.21.6 All the supply of material has already been taken. The stubbing of 21 out of 23 tower locations has been completed & erection of 9 Nos. towers including tapping Tower No.1 has been completed. The Construction work of line is in full swing and this transmission line is of utmost importance for increasing reliability and transmission capacity in the region, whose progress is monitored at the highest level.
- A.21.7 In view of above, he proposed to provide the approval for tapping arrangement for this 400KV line i.e LILO of 400KV Ludhian-Koladam line (CKT-II) at 400KV Ropar in the same pattern as in case of LILO of 400 KV Jalandhar-Kuruksetra (PGCIL) line at 400 KV Dhanansu (PSTCL).
- A.21.8 INDIGRID representative recommended not to go for tapping arrangement by using connectors and opening jumpers for long period. Further the line is heavily loaded and proposed T connector arrangement may get loosen and lead to red hot. If it is interim arrangement, then might be allowed.
- A.21.9 He also added that INDIGRID implemented LILO earlier in the same line by arranging extra tower, and not with the help of connectors.
- A.21.10 PSTCL representative stressed that there will be no tension on their string by doing tapping in the proposed way as the span to next tower (dead end) is 35 meters only. He addressed that it is LILO arrangement not a tapping as being considered by INDIGRID.
- A.21.11 POWERGRID representative conveyed that after checking the arrangement done in LILO of 400 KV Jalandhar-Kurukshetra (PGCIL) line at 400 KV Dhanansu (PSTCL), matter may be deliberated further.
- A.21.12 CGM, NRLDC advised to follow the same procedure for LILO arrangements as done earlier for LILO of 400 KV Jalandhar-Kuruksetra (PGCIL) line at 400 KV Dhanansu (PSTCL).
- A.21.13 MS, NRPC suggested INDIGRID and PSTCL to discuss the matter mutually and finalize the arrangements to be adopted in line with the CEA regulations.

**Decision of forum**

*Forum recommended INDIGRID and PSTCL to resolve the issue bilaterally and finalize the arrangements to be adopted in line with the CEA regulations. If require, issue could be discussed in next NRPC Meeting.*

**A.22 Installation of Reactive Power Solution on 33/11 kV Substations in Uttarakhand. (Rs. 58.99 Cr.) (agenda by UPCL)**

- A.22..1 UPCL representative apprised that due to hilly terrain of Dev Bhumi Uttarakhand, demographics and typical rural industrial load profile several parts of the state face issue of low voltage, poor power factor during some months. The DPR has been prepared so as to improve the voltage level and power factor in identified 33/11 kV substation in Uttarakhand which are facing voltage & power factor issues posing threat to Grid health.
- A.22..2 He added that UPCL is proposing along with appraisal of STU, 62 nos. 33/11 KV sub stations (101 Power Transformers) for Automatic Reactive Power Management system which were identified by analyzing minimum voltage and minimum power factor of all the 33/11 KV substations of UPCL in the time-span of January 2021 to December 2021.
- A.22..3 He highlighted that installation of Reactive Power Solution for real time power factor improvement, better voltage profile, less technical losses and low transformer loading will be targeted. The state network would be able to cater more consumers on existing infrastructure as well as it will improve the grid stability at higher voltages. It will further avoid unnecessary losses arising out of extra reactive power flow in the distribution & transmission company circuit network and posing threat to Grid health. These extra losses are basically national losses as they burden both Transmission Utility for expenditure in reactive power compensation and Distribution Company for bearing the unnecessary losses from the point of Reactive Power flow. Therefore, this project would be beneficial for both Distribution Company (UPCL), state Grid and to the National Grid in larger interest.
- A.22..4 100% funding is being proposed through PSDF for installation of Reactive Power Solution on 33/11 KV substation in Uttarakhand in the general interest of providing better power supply to the consumers as UPCL is not financially sound.

S.No	Proposa I No.	Utility/State	Name of Scheme	Cost of DPR
		UPCL/Uttarakhand	Installation of Reactive Power	Rs. 58.99

I/34026/2024

71<sup>st</sup> NRPC Meeting (29<sup>th</sup> January 2024)–MOM

			Solution on 33/11 kV Substations in Uttarakhand.	Cr.
--	--	--	---	-----

- A.22..5 MS, NRPC conveyed that the matter was deliberated in a separate meeting held on 22.01.2024 and proposal has been found justified considering the upcoming load demand of Uttarakhand in near future.
- A.22..6 In the aforesaid meeting, proposal was scrutinized and UPCL was asked to optimize its proposal in consultation with STU, whether any capacitor installation is proposed on 220KV level in near future.
- A.22..7 Further, UPCL had consulted the same with PTCUL and had informed that there is no such plan of STU of installing Capacitor on Transmission System in near future. The clarification on the same is attached as **Annexure- XX**.
- A.22..8 NRLDC representative informed that data of distribution substations mentioning low voltage and low power factor has been received from UPCL.
- A.22..9 NRLDC representative presented the excel sheet shared by UPCL and stated that there are some misrepresentations in excel shared from UPCL wherein some erroneous data is seen for some of the feeders.
- A.22..10 UPCL representative stated that the stations for which such data was erroneous, local data was gathered from substations and it has been submitted in DPR submitted to NRPC. It was further informed that data is for 378 substations out of which only 62 substations were identified where capacitor bank requirement has been proposed. Moreover, only for the stations for which low/acute low voltage issues are seen, capacitors have been proposed.
- A.22..11 UPCL representative further added that outliers in the data had been taken care by UPCL.

### **Decision of forum**

*Forum accorded approval to the proposal of installation of Reactive Power Solution on 33/11 kV Substations in Uttarakhand. (Rs. 58.99 Cr.) through PSDF.*

### **A.23 Implementation of Lucknow- Unchahar islanding scheme (agenda by UPSLDC)**

- A.23.1 UPSLDC representative informed that implementation of islanding scheme is getting delayed from NTPC unchahr end. He stated that as per their requirement UPPTCL has

I/34026/2024

*71<sup>st</sup> NRPC Meeting (29<sup>th</sup> January 2024)–MOM*

provided all possible support, however, no final timeline for completion of work is being given by NTPC end.

A.23.2 EE (O), NRPC informed that NTPC is taking up the matter as per last conversation with them.

A.23.3 MS, NRPC opined to have a separate meeting to deal islanding scheme issues.

***Decision of forum***

*NRPC Secretariat shall convene a separate meeting to resolve the deadlock.*

\*\*\*\*\*

List of addressee (via mail)					
NRPC Members for FY 2023-24					
S. No.	NRPC Member	Category	Nominated/Notified/Delegated Member	E-mail	
1	Member (GO&D), CEA	Member (Grid Operation & Distribution), Central Electricity Authority (CEA)	Member (GO&D), CEA	<a href="mailto:member.god@cea.nic.in">member.god@cea.nic.in</a>	
2	Member (PS), CEA	Nodal Agency appointed by the Government of India for coordinating cross-border power transactions	Member (PS), CEA	<a href="mailto:memberspscea@nic.in">memberspscea@nic.in</a>	
3	CTUIL	Central Transmission Utility	Chief Operating Officer	<a href="mailto:pcgarg@powergrid.in">pcgarg@powergrid.in</a>	
4	PGCIL	Central Government owned Transmission Company	Director (Operations)	<a href="mailto:tyagir@powergrid.in">tyagir@powergrid.in</a>	
5	NLDC	National Load Despatch Centre	Executive Director	<a href="mailto:scsaxena@grid-india.in">scsaxena@grid-india.in</a>	
6	NRLDC	Northern Regional Load Despatch Centre	Executive Director	<a href="mailto:nroy@grid-india.in">nroy@grid-india.in</a>	
7	NTPC	Central Generating Company	Director (Finance)	<a href="mailto:jaikumar@ntpc.co.in">jaikumar@ntpc.co.in</a>	
8	BBMB		Chairman	<a href="mailto:cmn@bbmb.nic.in">cmn@bbmb.nic.in</a>	
9	THDC		CGM (EM-Design)	<a href="mailto:akghildiyal@thdc.co.in">akghildiyal@thdc.co.in</a>	
10	SJVN		CMD	<a href="mailto:sectt.cmd@sjvn.nic.in">sectt.cmd@sjvn.nic.in</a>	
11	NHPC		Director (Technical)	<a href="mailto:raj कुमार0610.rkc@gmail.com">raj कुमार0610.rkc@gmail.com</a>	
12	NPCIL		Director (Finance)	<a href="mailto:df@npcil.co.in">df@npcil.co.in</a>	
13	Delhi SLDC		State Load Despatch Centre	General Manager	<a href="mailto:gmsldc@delhisldc.org">gmsldc@delhisldc.org</a>
14	Haryana SLDC			Chief Engineer (SO&C)	<a href="mailto:cesocomml@hvpn.org.in">cesocomml@hvpn.org.in</a>
15	Rajasthan SLDC			Chief Engineer (LD)	<a href="mailto:ce.ld@rvpn.co.in">ce.ld@rvpn.co.in</a>
16	Uttar Pradesh SLDC			Director	<a href="mailto:directorsldc@upsldc.org">directorsldc@upsldc.org</a>
17	Uttarakhand SLDC			Chief Engineer	<a href="mailto:anupam_singh@ptcul.org">anupam_singh@ptcul.org</a>
18	Punjab SLDC			Chief Engineer	<a href="mailto:ce-sldc@punjabsldc.org">ce-sldc@punjabsldc.org</a>
19	Himachal Pradesh SLDC	Chief Engineer		<a href="mailto:cehpsldc@gmail.com">cehpsldc@gmail.com</a>	
20	DTL	CMD		<a href="mailto:cmd@dtl.gov.in">cmd@dtl.gov.in</a>	
21	HVPNL	Managing Director		<a href="mailto:md@hvpn.org.in">md@hvpn.org.in</a>	
22	RRVPNL	CMD		<a href="mailto:cmd.rvpn@rvpn.co.in">cmd.rvpn@rvpn.co.in</a>	
23	UPPTCL	State Transmission Utility	Managing Director	<a href="mailto:md@upptcl.org">md@upptcl.org</a>	
24	PTCUL		Managing Director	<a href="mailto:md@ptcul.org">md@ptcul.org</a>	
25	PSTCL		CMD	<a href="mailto:cmd@pstcl.org">cmd@pstcl.org</a>	
26	HPPTCL		Managing Director	<a href="mailto:md.tcl@hpmail.in">md.tcl@hpmail.in</a>	
27	IPGCL		Managing Director	<a href="mailto:md.ipgpc@nic.in">md.ipgpc@nic.in</a>	
28	HPGCL		Managing Director	<a href="mailto:md@hpgcl.org.in">md@hpgcl.org.in</a>	
29	RRVUNL		CMD	<a href="mailto:cmd@rrvunl.com">cmd@rrvunl.com</a>	
30	UPRVUNL		Director (Technical)	<a href="mailto:director.technical@uprvunl.org">director.technical@uprvunl.org</a>	
31	UJVNL	State Generating Company	Managing Director	<a href="mailto:mdujvnl@ujvnl.com">mdujvnl@ujvnl.com</a>	
32	HPPCL		Managing Director	<a href="mailto:md@hpgcl.in">md@hpgcl.in</a>	
33	PSPCL		State Generating Company & State owned Distribution Company	CMD	<a href="mailto:cmd-pspcl@pspcl.in">cmd-pspcl@pspcl.in</a>
34	DHBVN	State owned Distribution Company (alphabetical rotational basis/nominated by state govt.)	Director (Projects)	<a href="mailto:directorprojects@dhbvn.org.in">directorprojects@dhbvn.org.in</a>	
35	Jaipur Vidyut Vitran Nigam Ltd.		Managing Director	<a href="mailto:md@jvnl.org">md@jvnl.org</a>	
36	Madhyanchal Vidyut Vitaran Nigam Ltd.		Managing Director	<a href="mailto:mdmvnl@gmail.com">mdmvnl@gmail.com</a>	
37	UPCL		Managing Director	<a href="mailto:md@upcl.org">md@upcl.org</a>	
38	HPSEB		Managing Director	<a href="mailto:md@hpseb.in">md@hpseb.in</a>	
39	Prayagraj Power Generation Co. Ltd.		Head (Commercial & Regulatory)	<a href="mailto:sanjay.bhargava@tatapower.com">sanjay.bhargava@tatapower.com</a>	
40	Aravali Power Company Pvt. Ltd.		CEO	<a href="mailto:SRBODANKI@NTPC.CO.IN">SRBODANKI@NTPC.CO.IN</a>	
41	Apraava Energy Private Limited	CEO	<a href="mailto:rajneesh.setia@apraava.com">rajneesh.setia@apraava.com</a>		
42	Talwandi Sabo Power Ltd.	COO	<a href="mailto:Vibhav.Agarwal@vedanta.co.in">Vibhav.Agarwal@vedanta.co.in</a>		
43	Nabha Power Limited	CEO	<a href="mailto:sk.narang@larsentoubro.com">sk.narang@larsentoubro.com</a>		
44	Lanco Anpara Power Ltd	IPP having more than 1000 MW installed capacity	President	<a href="mailto:sudheer.kothapalli@meilanparapower.com">sudheer.kothapalli@meilanparapower.com</a>	
45	Rosa Power Supply Company Ltd		Station Director	<a href="mailto:Hirday.tomar@relianceada.com">Hirday.tomar@relianceada.com</a>	
46	Lalitpur Power Generation Company Ltd		Managing Director	<a href="mailto:vksbankoti@bajajenergy.com">vksbankoti@bajajenergy.com</a>	
47	MEJA Urja Nigam Ltd.		CEO	<a href="mailto:hopmeja@ntpc.co.in">hopmeja@ntpc.co.in</a>	
48	Adani Power Rajasthan Limited		COO, Thermal, O&M	<a href="mailto:jayadeb.nanda@adani.com">jayadeb.nanda@adani.com</a>	
49	JSW Energy Ltd. (KWHEP)		Head Regulatory & Power Sales	<a href="mailto:vyotiprakash.panda@jsw.in">vyotiprakash.panda@jsw.in</a>	
50	RENEW POWER		IPP having less than 1000 MW installed capacity (alphabetical rotational basis)	CEO	<a href="mailto:sumant@renew.com">sumant@renew.com</a>
51	UT of J&K	From each of the Union Territories in the region, a representative nominated by the administration of the Union Territory concerned out of the entities engaged in generation/ transmission/ distribution of electricity in the Union Territory.	Chief Engineer, JKPTCL	<a href="mailto:sojidd@gmail.com">sojidd@gmail.com</a>	
52	UT of Ladakh		Chief Engineer, LPDD	<a href="mailto:cepladakh@gmail.com">cepladakh@gmail.com</a>	
53	UT of Chandigarh		Executive Engineer, EWEDC	<a href="mailto:elop2-chd@nic.in">elop2-chd@nic.in</a>	
54	BYPL	Private Distribution Company in region (alphabetical rotational basis)	CEO	<a href="mailto:Amarjeet.Sheoran@relianceada.com">Amarjeet.Sheoran@relianceada.com</a>	
55	Bikaner Khetri Transmission Limited	Private transmission licensee (nominated by central govt.)	Vice-President	<a href="mailto:nihar.raj@adani.com">nihar.raj@adani.com</a>	
56	Adani Enterprises	Electricity Trader (nominated by central govt.)	Head Power Sales & Trading	<a href="mailto:anshul.garg@adani.com">anshul.garg@adani.com</a>	
57	Ajmer Vidyut Vitran Nigam Ltd.	Special Invitee	Managing Director	<a href="mailto:md.avnl@rajasthan.gov.in">md.avnl@rajasthan.gov.in</a>	
Special Invitees:					
RE Holding companies in NR with installed capacity of more than 1000 MW (provisional members as decided in 59th NRPC meeting)					



## **Special Invitees:**

1. Shri. Chowna Mein, Hon'ble Dy. Chief Minister and I/C Power, Govt. of Arunachal Pradesh, Block No.2, 5<sup>th</sup> Floor, A.P. Civil Secretariat, Itangar-791111. [Email: [chowna.mein@gov.in](mailto:chowna.mein@gov.in)]Tel -03602212671
2. Shri Ginko Lingi, Chairman, TCC, NERPC & Chief Engineer (P), TPMZ , Department of Power, Govt. of Arunachal Pradesh, Vidyut Bhawan, zero Point, Itanagar-791111. [Email: [ginko.lingi@gmail.com](mailto:ginko.lingi@gmail.com)] Tel -9612153184
3. Shri K Vijayanand, Chairperson, SRPC, Chairman & Managing Director , Transmission Corporation of Andhra Pradesh Limited, Vidyut Soudha, Gunadala, Eluru Rd, Vijayawada, Andhra Pradesh 520004. [Email: [cmd.aptransco@aptrandco.in](mailto:cmd.aptransco@aptrandco.in) ; [vjanand@nic.in](mailto:vjanand@nic.in) ] Tel -08662429201
4. Shri AKV Bhaskar, Chairperson TCC, SRPC, Director (Trasmission & Grid Management), Transmission Corporation of Andhra Pradesh Limited, Vidyut Soudha, Gunadala,Eluru Rd, Vijayawada, Andhra Pradesh 520004. [ Email: [kannanvenkatabhaskar.angulabharanam@aptransco.co.in](mailto:kannanvenkatabhaskar.angulabharanam@aptransco.co.in)] Tel -.08662429209
5. Sri Nikunja Bihari Dhal, IAS, Chairman, ERPC, Additional Chief Secretary to Govt., Department of Energy, Govt. of Odisha, Bhubaneswar. [Email-[chairman@gridco.co.in](mailto:chairman@gridco.co.in) ] Tel -06742540098
6. Shri Trilochan Panda, Managing Director, GRIDCO, Chairperson TCC, ERPC, GRIDCO Limited, Regd. Office: Janpath, Bhubaneswar – 751022. Tel -06742540877 [Email- [md@gridco.co.in](mailto:md@gridco.co.in) ]
7. Shri Sanjay Dubey, Chairman, WRPC & Principal Secretary(Energy), GoMP, VB-2, Vallabh Bhawan Annex, Mantralay, Bhopal: 462 001 (M.P.), Email: [psenergyn@gmail.com](mailto:psenergyn@gmail.com), Tel. 0755-2708031
8. Shri Raghuraj Rajendran, Chairman-TCC, WRPC & Managing Director MPPMCL, Block No-15, Shakti Bhawan, Vidyut Nagar, Rampur, Jabalpur-482008. [Email-[mdofmppmcl@gmail.com](mailto:mdofmppmcl@gmail.com)]
9. Smt. Rishika Saran, Member Secretary, NPC, Sewa Bhawan, R. K. Puram, New Delhi-66 [Email-[cenpc-cea@gov.in](mailto:cenpc-cea@gov.in)]
10. Shri Deepak Kumar, Member Secretary, WRPC, Plot No- F-3, MIDC Area, Marol, Opp. SEEPZ, Central Road, Andheri (East), Mumbai-40093.[ email: [ms-wrpc@nic.in](mailto:ms-wrpc@nic.in)] Tel - 02228221636
11. Shri Asit Singh, Member Secretary, SRPC, No.29, Race Course Cross Road, Bengaluru-560009. [Email: [mssrpc-ka@nic.in](mailto:mssrpc-ka@nic.in)] Tel -08022287205/9449047107
12. Shri N.S. Mondal, Member Secretary, ERPC,14,Golf Club Road, ERPC Building, Tollygunje,Kolkata-700033. [Email: [mserpc-power@nic.in](mailto:mserpc-power@nic.in) ]- Tel 03324239651/9958389967
13. Shri K B Jagtap, Member Secretary, NERPC, NERPC Complex, Dong Parmaw, Lapalang, Shillong-793006. [Email: [ms-nerpc@gov.in](mailto:ms-nerpc@gov.in) ] Tel [-03642534077/8652776033](tel:-03642534077/8652776033)
14. Shri Chandra Prakash, Chief Engineer, GM Division, CEA, Sewa Bhawan, R. K. Puram, New Delhi-66 [Email: [cp\\_cea@nic.in](mailto:cp_cea@nic.in)]

\*\*\*\*\*



भारत सरकार  
Government of India  
विद्युत मंत्रालय  
Ministry of Power  
उत्तर क्षेत्रीय विद्युत समिति  
Northern Regional Power Committee

सं. उक्षेविस/ वाणिज्यिक/ 209/ आर पी सी (62वीं)/2023/1780-1827

दिनांक: 20, फ़रवरी, 2023

सेवा में / To,

उ.क्षे.वि.स. के सभी सदस्य (संलग्न सूचीनुसार)  
Members of NRPC (As per List)

**विषय: उत्तर क्षेत्रीय विद्युत समिति की 62<sup>वीं</sup> बैठक का कार्यवृत्त ।**  
**Subject: 62<sup>nd</sup> meeting of Northern Regional Power Committee – MoM**

महोदय / Sir,

उत्तर क्षेत्रीय विद्युत समिति की 62<sup>वीं</sup> बैठक दिनांक 31<sup>st</sup> जनवरी, 2023 को 1100 बजे विडियो कॉन्फ्रेंसिंग के माध्यम से आयोजित की गयी थी। बैठक का कार्यवृत्त संलग्न है। यह उ.क्षे.वि.स. की वेबसाइट (<http://164.100.60.165/>) पर भी उपलब्ध है।

The 62<sup>nd</sup> meeting of Northern Regional Power Committee (NRPC) was held at 1100 Hrs on 31<sup>st</sup> January, 2023 via video conferencing. MoM of the same is attached herewith. The same is also available on NRPC Sectt. website (<http://164.100.60.165/>).

भवदीय

Yours faithfully,

*Naresh*  
(नरेश भंडारी) 20/2/23

(Naresh Bhandari)

सदस्य सचिव

Member Secretary

- A.6.7 CGM (I/C), NRLDC stated that till the time, report is approved by NPC Division, CEA, we may approve PMUs at each 220 KV bus of POI sub-station at least. He stated that sub-stations in Bikaner and Fatehgarh may be targeted.
- A.6.8 MS, NRPC asked POWERGRID to provide estimate for PMUs and its cost.
- A.6.9 POWERGRID stated that for Fatehgarh-II, Bhadla, Bikaner, and Bhadla-II, there may be requirement of 13 PMUs in case of open condition of Bus-Sectionalizer. If, bus-sectionalizer is considered close, 8 PMUs may be required.
- A.6.10 MS, NRPC enquired cost of 8 PMUs. POWERGRID confirmed estimated cost as Rs. 1.5 Cr.
- A.6.11 Considering urgency expressed by NRLDC, forum accorded the approval for 8 nos. PMU at each 220 KV bus of Fatehgarh-II, Bhadla, Bikaner, and Bhadla-II s/s of POWERGRID at an estimated cost of Rs. 1.5 Cr.

**A.7 OPGW installation on 400kV D/C Malerkotla – Kurukshetra line (Owned by M/s Sekura) (Agenda by CTU)**

- A.7.1 CTU representative apprised the forum that Reliable Communication Scheme for Central Sector in Northern region covering installation of 7398 kms OPGW was agreed for implementation by POWERGRID in the 39<sup>th</sup>, 40<sup>th</sup> & 47<sup>th</sup> NRPC meetings held on 02.05.2017, 28.10.2017 & 11.12.2019 respectively.
- A.7.2 As part of the above scheme, Installation of OPGW on 400kV Kurukshetra - Malerkotla line by POWERGRID by replacing the existing earth wire was also envisaged. It is pertinent to mention that 400kV Kurukshetra - Malerkotla transmission line was constructed under TCB route by M/s Sekura NRSS-XXXI (B) Trans Ltd (M/s Sekura) & was commissioned on 18.01.2017 with two Earthwire(s) without OPGW as per the relevant RFP.
- A.7.3 However, due to issues raised by M/s Sekura regarding indemnification towards outage/ tripping during the installation of OPGW and return of the earth wire replaced by OPGW, work wasn't started.
- A.7.4 In this regard, a petition vide Petition No. 94/MP/2021 had been filed by CTU before Hon'ble Central Electricity Regulatory Commission (CERC) seeking directions from CERC regarding installation of OPGW on the 400kV Kurukshetra - Malerkotla transmission line.
- A.7.5 On 29<sup>th</sup> Mar'22, CTU has submitted a compliance certificate before CERC mentioning that POWERGRID has communicated that it has no objection if the implementation of laying of OPGW is undertaken by M/s Sekura.
- A.7.6 M/s Sekura vide letter dtd. 23.01.2023 (**Annexure VI**) has given their consent for installation of OPGW on the 400kV Kurukshetra - Malerkotla line (140km) and has submitted detailed proposal.
- A.7.7 In view of above, it is proposed that M/s Sekura shall install the 24 F OPGW (approx. cost of Rs.7 Cr. for 140 Km) on the said line in live line conditions as per the broad specifications provided by CTU for RTM Projects with completion schedule of 18 months from the date of allocation.
- A.7.8 Representative from M/s Sekura apprised the forum that the petition which was filed by CTU last year is still subjudice before Hon'ble CERC. Last year, PGCIL stated through CTU affidavit that it has no objection if the said OPGW is laid by M/s Sekura Based on that affidavit and hearing from all the parties at CERC, the commission

directed that all party should rework and settle most of the issues mutually and report to commission for the limited issues. Based on that hearing and direction and statement given by CTU, M/s Sekura started assessment and feasibility of laying OPGW on 400kV Kurukshetra - Malerkotla line.

- A.7.9 He also apprised the forum that in their recent proposal to CTU, M/s Sekura has proposed that they intended to lay optical fibers of 48 core in both the lines while earlier in the 47<sup>th</sup> NRPC meeting, the scheme was limited to Kurukshetra line with 24 core. The deviations from the initial scheme is proposed in view of future requirements. He apprised the forum that 48 Core OPGW costs nearly 10-12% higher than 24 Core. He highlighted that this is a sectorial issue and passing any order in this meeting may derail CERC's opinion.
- A.7.10 MS, NRPC stated that since the Commission had directed M/s Sekura to rework and settle the issue through mutual discussion, the same may be discussed in the forum.
- A.7.11 Representative from M/s Sekura opined that putting up this agenda for approval before NCT will not be appropriate at this point of time because anything which is going to be put up before NCT should be either a fresh package or there is some requirement of modification of existing infrastructure. Since the OPGW installation on line is neither a new project as such nor a modification of existing infrastructure. Here only the earth wire is being replaced by OPGW.
- A.7.12 Representative from CTU opined that as far as RFP is concerned, 24 core fibre is considered for straight lines and for the LILO portion, 48 fibre core is considered. Secondly, the deviation that M/s Sekura has proposed is after the affidavit submitted in this regard to CERC. The changes that NRSS has proposed are not as per norms of RTM.
- A.7.13 MS, NRPC asked CTU to give reply to the letter of M/s Sekura and then may apprise this matter before CERC. This is because the project is under TBCB and therefore a proper method is required to be formulated for any extra expenses in this project.
- A.7.14 He raised serious concern over the delay of the project and stated that it is affecting the reliability of our effective grid operation due to absence of this communication scheme.
- A.7.15 NRPC Forum noted that the scheme was approved in 2018 and still the project is incomplete. The forum stressed that the issue may be worked out by CTU, POWERGRID and M/s Sekura and Hon'ble CERC may be apprised accordingly for decision on the matter.
- A.7.16 The forum also highlighted that if there is any plan of M/S Sekura for revenue sharing for OPGW, M/S Sekura may inform upfront to CERC so that a holistic decision may be taken by the Commission.

## **A.8 Non-payment of outstanding dues by DTL (Agenda by SJVN)**

- A.8.1 SJVN apprised the forum that they had signed the Power Purchase Agreement with Delhi Transco Ltd (DTL) for selling the power of Naphtha Jhakri Hydro Power Station to Delhi on 27.03.2003 as per allocation made by MoP, Government of India.
- A.8.2 DERC vide order no. F.17 (115)/Engg./DERC/2006-07 dated 31.03.2007 had assigned the Power Purchase Agreements between DTL and various CPSUs to Delhi Discoms (BRPL, BYPL and NDPL, now TPDDL) w.e.f. 01.04.2007. DTL is no more in business with SJVN for power supply from NJHPS and paid all its energy payments for the sale of power from NJHPS before it was assigned to Delhi Discoms.

**CENTRAL ELECTRICITY REGULATORY COMMISSION  
NEW DELHI**

**Petition No. 94/MP/2021**

**Coram:**

**Shri Jishnu Barua, Chairperson**

**Shri I. S. Jha, Member**

**Shri Arun Goyal, Member**

**Shri P. K. Singh, Member**

**Date of Order: 27.12.2023**

**In the matter of:**

Petition under Section 79(1)(f) of the Electricity Act, 2003 read with Regulation 111 of the Central Electricity Regulatory Commission (Conduct of Business) Regulations, 1999 seeking directions for installation of optical ground wire for the 400kV Kurukshetra – Malerkotla transmission line established under the Northern Region System Strengthening Scheme XXXI(B).

**And**

**In the matter of:**

Central Transmission Utility,  
(Power Grid Corporation of India Ltd).  
B-9, Qutab Industrial Area,  
Katwaria Sarai, New Delhi-110016

**.....Petitioner**

**Versus**

1. Sekura NRSS XXXI(B) Transmission Ltd.,  
503, Windsor, off CST Road, Kalina, Santacruz (E), Mumbai-400098 (Maharashtra)
2. Northern Regional Power Committee  
18-A, Shaheed Jeet Singh Marg, Qutab Institutional Area, New Delhi-110016
3. Central Electricity Authority,  
Sewa Bhawan, Rama Krishna Puram, Sector -1, New Delhi-110066
4. National Load Despatch Centre,  
B-9, First Floor, Qutab Institutional Area, Katwaria Sarai, New Delhi-110016
5. Northern Regional Load Despatch Centre,  
18-A, Shaheed JEET Singh, Sansanwal Marg, Katwaria Sarai, New Delhi-110016
6. Khargone Transmission Ltd.,  
F1, The Mira Corporate Suite, Plot No.1 &2, C-Block, 2<sup>nd</sup> Floor, Ishwar Nagar,



- Mathura Road, New Delhi-110065
7. NER-II Transmission Ltd.  
F1, The Mira Corporate Suite, Plot No.1 &2, C-Block, 2<sup>nd</sup> Floor, Ishwar Nagar,  
Mathura Road, New Delhi-110065
  8. East North Interconnection Company Ltd.,  
The Mira Corporate Suite, Plot No.1 &2, C Block, 2<sup>nd</sup> Floor, Ishwar Nagar,  
Mathura Road, New Delhi-110065
  9. Bhopal Dhule Transmission Company Ltd.,  
The Mira Corporate Suite, Plot No.1 &2, C Block, 2<sup>nd</sup> Floor, Ishwar Nagar,  
Mathura Road, New Delhi-110065
  10. Jabalpur Transmission Company Ltd.,  
The Mira Corporate Suite, Plot No.1 &2, C Block, 2<sup>nd</sup> Floor, Ishwar Nagar,  
Mathura Road, New Delhi-110065
  11. NRSS XXIV Transmission Ltd.,  
The Mira Corporate Suite, Plot No.1 &2, C Block, 2<sup>nd</sup> Floor, Ishwar Nagar,  
Mathura Road, New Delhi-110065
  12. Purulia & Kharagpur Transmission Co. Ltd.,  
The Mira Corporate Suite, Plot No.1 &2, C Block, 2<sup>nd</sup> Floor, Ishwar Nagar,  
Mathura Road, New Delhi-110065
  13. RAPP Transmission Company Ltd.,  
The Mira Corporate Suite, Plot No. 1&2, C Block, 2<sup>nd</sup> Floor, Ishwar Nagar,  
Mathura Road, New Delhi-110065
  14. Maheshwaram Transmission Ltd.,  
The Mira Corporate Suite, Plot No. 1&2, C Block, 2<sup>nd</sup> Floor, Ishwar Nagar,  
Mathura Road, New Delhi-110065
  15. Gurgaon Palwal Transmission Ltd.,  
The Mira Corporate Suite, Plot No. 1&2, C Block, 2<sup>nd</sup> Floor, Ishwar Nagar,  
Mathura Road, New Delhi-110065
  16. Odisha Generation Phase-II Transmission Ltd.,  
The Mira Corporate Suite, Plot No. 1&2, C Block, 2<sup>nd</sup> Floor, Ishwar Nagar,  
Mathura Road, New Delhi-110065
  17. Patran Transmission Company Ltd.,  
The Mira Corporate Suite, Plot No. 1&2, C Block, 2<sup>nd</sup> Floor, Ishwar Nagar,  
Mathura Road, New Delhi-110065
  18. Western Transco Power Ltd.(WTPL)  
Achalraj, Opp.Mayor Bungalow, Law Garden, Ahmedabad-380006
  19. Western Transmission (Gujarat) Ltd., (WTGL)  
Achalraj, Opp. Mayor Bungalow, Law Garden, Ahmedabad-380006
  20. Chhattisgarh WR Transmission Ltd.,  
Achalraj, Opp. Mayor Bungalow, Law Garden, Ahmedabad-380006
  21. Raipur Rajnandgaon Warora Transmission Ltd.,  
Achalraj, Opp. Mayor Bungalow, Law Garden, Ahmedabad-380006
  22. Sipat Transmission Limited  
Achalraj, Opp. Mayor Bungalow, Law Garden, Ahmedabad-380006



23. Raichur Sholapur Transmission Co. Ltd.,  
Patel Estate, S. V. Road, Jogeshwari (West), Mumbai-400102
24. POWERGRID Vizag Transmission Ltd.,  
POWERGRID, SR HQ, 6th Floor, D. No. 6-6-8/32 &39/E, Kavadiguda,  
Secunderabad-500080, Telangana
25. POWERGRID Unchahar Transmission Ltd.,  
765/400/220 KV POWERGRID S/S, Fatehpur-Lalganj-Lucknow Road,  
Village- Chauferva, Post & Distt-Fatehpur-212601(Uttar Pradesh)
26. Kudgi Transmission Ltd.,  
Mount Poonamallee Road, Manapakkam, P.B. No.979, Chennai-600089
27. Darbhanga Motihari Transmission Co. Ltd.,  
503, Windsor, Off CST Road, Kalina, Santacruz (E), Mumbai -40009 (Maharashtra)
28. NRSS XXXVI Transmission Ltd.,  
Plot No. 19, Film City, Sec-16 A, Gautam Buddha Nagar, Noida, UP-201301
29. Warora Kurnool Transmission Ltd.,  
Achalraj, Opp. Mayor Bungalow, Law Garden Ahmedabad-380006
30. POWERGRID Southern Inter Connector Transmission System Ltd (PSITSL),  
POWERGRID, SR1 HQ, D.No.6-6-8/32&395/E, Kavadiguda,  
Secunderabad-500080, Telangana
31. POWERGRID Parli Transmission Ltd (PPTL),  
Sampriti Nagar, Nari Ring Road, Uppalwadi, Nagpur-440026
32. POWERGRID Kala Amb Transmission Ltd.  
(PKATL) 400/220KV Barwala Sub-station, Vill-Naggal, NH-73,  
Barwala Panchkula, Haryana-134118
33. POWERGRID Warora Transmission Ltd, (PWTL)  
WR-1 RHQ, Sampriti Nagar, Nari Ring Road,  
PO: Uppalwadi, Nagpur-440026(Maharashtra)
34. Powergrid NM Transmission Limited Southern  
Region Transmission system –II, RHQ, Near Driving Test Track,  
Singanayakanhalli, Yelahanka Hobli, Bangalore-560064
35. Powergrid Jabalpur Transmission Limited, POWERGRID,  
Plot No. 54, Jay Ambe School, Sama-Savli Road, Vadodara-390018, Gujarat
36. Alipurduar Transmission Ltd.(ATL)  
Achalraj, Opp. Mayor Bungalow, Law Garden Ahmedabad-380006
37. KOHIMA-MARIANI Transmission Ltd.,  
B-5, Tower-3, 3rd Floor, Okaya Business Centre,  
Sector-62, Noida, (Uttar Pradesh) 201306, India
38. POWERGRID Medinipur Jeerat Transmission Ltd.  
POWERGRID, Eastern Region II Headquarters, CF-17,  
Action Area 1C, New Town, Rajarhat, Kolkata-700156
39. POWERGRID Mithilanchal Transmission Ltd.  
POWERGRID, ERTS-I Regional Haed Quarter, Near Transformer Repair Works,  
Board Colony, Shastri Nagar, Patna-800023 (Bihar)
40. POWERGRID Ajmer Phagi Transmission Ltd. SCO bay 5 to 10,



SECTOR-16A, FARIDABAD, HARYANA- 121002

41. Power Grid Corporation of India Ltd.  
Load Dispatch & Communication (LD&C), B-9,  
Qutab Institutional Area, Katwaria Sarai, New Delhi-110016 .....Respondents

**Parties Present:**

Shri Samar Chandra De, NERLDC  
Shri M. G. Ramachandran, Senior Advocate, STL  
Ms. Suparana Srivastava, Advocate, CTUIL  
Shri Tushar Mathur, Advocate, CTUIL  
Ms. Astha Jain, Advocate, CTUIL  
Shri Shubham Arya, Advocate, STL  
Ms. Shikha Sood Advocate, STL  
Ms. Reeha Singh, Advocate, STL  
Ms. Pallavi Maitra, Advocate R-7 to 12  
Shri Venkatesh, Advocate, NRSS XXXVI  
Shri Anand Singh Ubeja, Advocate, NRSS XXXVI  
Shri Mohit Mansharamani, Advocate, NRXX XXXVI  
Shri Hemant Singh, Advocate, WTPL  
Shri Chetan Garg, Advocate, WTPL  
Shri Swapnil Verma, CTUIL  
Shri Ranjeet S. Rajput, CTUIL  
Shri Priyansi Jadya, CTUIL

**ORDER**

Central Transmission Utility (CTU) has filed the present Petition under Section 79(1)(f) of the Electricity Act, 2003, read with Regulation 111 of the Central Electricity Regulatory Commission (Conduct of Business) Regulations, 1999, seeking directions for installation of optical ground wire for the 400kV Kurukshetra – Malerkotla transmission line established under the Northern Region System Strengthening Scheme XXXI(B).

2. The Petitioner has made the following prayers:
- i. *Issue appropriate directions to Respondent No.1 for allowing OPGW installation on the 400kV Kurukshetra-Malerkotla D/c line under the Reliable Communication Project approved for the Northern Region by Northern Region Power Committee to ensure early completion of the link.*
  - ii. *Issue further appropriate directions to Respondent No.1 for facilitating and allowing OPGW installation in the transmission elements implemented by transmission licensees in line with the mandate of Central Electricity Authority (Technical Standards for Communication System in Power System Operations) Regulations, 2020; any other applicable Regulations/Procedure in this regard, orders and directions of this Hon'ble Commission and*





*the decision of coordinated meetings between entities such as Regional Power Committees (RPC), Central Electricity Authority (CEA), Central Transmission Utility (CTU), National/Regional Load Despatch Centres (NLDC/RLDC) and other statutory/regulatory stakeholders.*

- iii. *Pass such further and other order(s) as this Hon'ble Commission may deem fit and proper in the facts and circumstances of the present case.*

### **Submission of Petitioner**

3. Petitioner has made the following submissions:
- (a) Communication systems are essential to facilitate the secure, reliable and economic operation of the grid and are an important pre-requisite for the efficient monitoring, operation and control of the power system. The provisions relating to communication systems for the power sector have been initially spelt out in the Central Electricity Regulatory Commission (Indian Electricity Grid Code) Regulations, 2010 (hereinafter "Grid Code, 2010") and the Central Electricity Authority (Technical Standard for Connectivity to the Grid) Regulation, 2013 (hereinafter "Grid Standard for Connectivity") whereunder, all requesters, users, Central/State Transmission Utilities are obligated to provide systems to telemeter power system parameters. Thereafter, on 15.5.2016, this Commission notified the Central Electricity Regulatory Commission (Communication System for inter-State transmission of electricity) Regulations, 2017 (hereinafter "Communication System Regulations, 2017"), which lay down the rules, guidelines, and standards to be followed by various persons and participants in the system for the continuous availability of data for system operation and control including market operations.
- (b) Petitioner has been entrusted with the responsibility for the development of an efficient and coordinated communication system on a regional basis, which is to be connected to provide a backbone communication system spread across India as per the Manual of Communication Planning Criteria of the Central Electricity Authority, 2019. CEA has further notified the Central Electricity Authority (Technical Standards for Communication System in Power System Operations) Regulations, 2020 (hereinafter "Communication Standards Regulations, 2020"), laying down the requirements for planning, implementation, operation and maintenance and up-gradation of a reliable communication system for all communication requirements including exchange of data for power system at the national level, regional level,



inter-State level and intra-State level. The Regulations envisage planning of backbone regional and national communication network using ISTS transmission lines by the Petitioner as per requirement.

- (c) The Communication Standards Regulations, 2020, envisage planning of backbone regional and national communication network using ISTS transmission lines by the Petitioner as per requirement. Regulation 26 of the said Regulations necessitates the construction of wideband communications using fibre optic communication.
- (d) Optical Ground Wire (OPGW) is an optical fibre embedded in the earth wire, which is used in overhead power lines. In furtherance of the regulatory mandate, the Petitioner has established the backbone communication network in the Northern Region as part of various projects such as the Unified Load Despatch & Communication (ULDC) Project, Microwave Replacement Project and Fiber Optic Expansion Projects, apart from other transmission projects.

The Reliable Communication Scheme under the Central Sector for Northern Region was proposed by the Petitioner in the 35th Technical Coordination Committee (TCC) Meeting held on 1.5.2017, which was approved in the 39th Meeting of the Northern Regional Power Committee held on 2.5.2017.

In this manner, the scheme for the installation of OPGW based reliable communication system with a network size of 7248kms (including OPGW replacement of ULDC Phase –I) by the Petitioner in the Northern Region was approved for its implementation. In accordance with the above approval, which was reiterated in the 40th Meeting, the Petitioner proceeded with the installation of around 7248 km of OPGW along with the communication equipment under the central sector in the Northern Region.

- (e) The implementation of an additional network with the Reliable Communication Scheme under the Central Sector for the Northern Region was approved in the 47th Meeting of the Northern Regional Power Committee held on 11.12.2019 and in the 44th Meeting of the Technical Coordination Committee held on 10.12.2019. Accordingly, the revised network size of the Reliable Communication Project will become 7398 Km. As a part of the above scheme, OPGW was also agreed to be installed on the 400kV Kurukshetra-Malerkotla line (180km) by replacing the existing earth wire.



- (f) The Petitioner has taken up implementation of the project wherein OPGW is to be installed on ISTS transmission lines by replacing existing earth wire. For that purpose, the Petitioner has entered into a contract dated 31.1.2019 with M/s Apar Industries Ltd. (APAR) after the selection of the same based on an open tender.
- (g) The 400kV ISTS transmission line connecting Kurukshetra-Malerkotla had been implemented by Respondent No.1 as part of the transmission scheme in the name of “Northern Region System Strengthening Scheme XXXI (B)” through the TBCB route as follows:
- i. 400 kV Kurukshetra-Malerkotla D/c line
  - ii. 400 kV Malerkotla-Amritsar D/c line
- (h) In view of the regulatory mandate for implementing the national backbone communication system, including for the Northern Region, the Petitioner approached Respondent No.1 for the installation of OPGW on the 400kV D/c Kurukshetra- Malerkotla line built by the Respondent. Further, vide email dated 15.9.2020, the Petitioner clarified certain queries raised by Respondent No.1
- (i) Respondent No.1 vide letter dated 5.10.2020 raised issues with respect to the installation of OPGW on the 400kV Kurukshetra-Malerkotla transmission line and stated that it was unable to understand the regulatory provision which allowed that part of TBCB asset could be removed/dismantled and adjusted against the capital cost of other cost-plus assets in order to achieve tariff optimization in cost plus project. As such, Respondent No.1 declined to grant its consent “to take away NTL earth wire including hardware & fittings by M/s. APAR Industries Ltd. after dismantling for executing OPGW Work”. Respondent No.1 also sought clarifications from the Petitioner with respect to the following:
- i. The available regulatory provisions and contractual provisions under the TSA under which implementation of OPGW ULDC scheme through its asset would not entail any impact on the revenue of the asset.
  - ii. Petitioner to hand over the verified quantity of earth wire, including accessories to Respondent No.1 after proper re-rolling on drums at its Patiala store.



- iii. Whether any damage to the assets of Respondent No.1 during the installation of OPGW by the Petitioner would be rectified by the Petitioner at its own to the level of satisfaction of Respondent No.1.
  - iv. Petitioner to provide schedule of work execution, planning, details of executing agency etc., to Respondent No.1 prior to mobilizing the work at the site for joint discussion purposes.
  - v. Whether the Petitioner would indemnify Respondent No.1 towards:
    - a. Outage/tripping of line implemented by Respondent No.1, which might reduce transmission line service availability.
    - b. Any perspective dispute, litigation or (RoW/crop) compensation claims raised by any of the landowners.
  - vi. From the lifetime operation and maintenance perspective after the completion, commissioning and capitalization of the OPGW work, clarification with respect to:
    - a. Ownership of the transmission line, particularly in view of the substitution of earth wire by the Petitioner and if the asset was to be handed over to Respondent No.1 for ease of its operation and maintenance in future.
    - b. Whether the Petitioner intended to utilize the transmission line commercially in any manner.
- (j) Petitioner vide letter dated 12.10.2020 informed Respondent No.1 that live-line installation of OPGW was field proven and more than 70,000 kms of installation had been completed by the Petitioner. As regards the return of earth-wire and other issues raised by Respondent No.1, the Petitioner stated that the same could be dealt with in line with the decision taken during the Meeting chaired by the Member Secretary, Northern Region Power Committee on 5.3.2019 on similar issues raised by M/s Parbati Koldam Transmission Company Limited (PKTCL) for OPGW installation on their lines. Petitioner's prayers are liable to be seen in the context and perspective of the obligations of Respondent No.1 in terms of the Transmission Service Agreement dated 02.01.2014.
- (k) Respondent No.1 is also obligated in terms of the provisions of the CERC (Procedure, Terms and Conditions for grant of Transmission License and other



related matters) Regulations, 2009, to maintain the project in accordance with the prudent utility practices and applicable directions passed by competent authorities.

- (l) The OPGW requirement on the said line under the Reliable Communication Project is vital for providing reliable and redundant communication of Malerkotla 400kV ISTS sub-station to the Northern Region Load Despatch Center and the Malerkotla 400 kV ISTS sub-station is important for evacuation of bulk power to Punjab through the downstream of 800 kV Champa-Kurukshetra HVDC line.
- (m) Respondent No.1 or any similarly placed transmission licensee may have inter alia the following concerns or issues, on which the Commission may be pleased to issue appropriate guidance and directions:
- i. Change in value (if any) of their assets upon replacement of existing earth-wire with OPGW (optical ground-wire) when such installation is being carried out at the behest of CTU/POWERGRID.
  - ii. Impact of this change in assets on the tariff (if any).
  - iii. Impact of tripping and shutdowns on their system availability (if any)
  - iv. Ownership of OPGW.
  - v. Permission for the licensee to use OPGW for any commercial purpose.
- (n) The Commission may issue directions and guidance in general governing the installation of OPGW wherever so required in accordance with the mandate of Communication Standards Regulations, 2020, Communication System Regulations, 2017 or any other applicable Regulations/Procedure in this regard; orders and directions of this Commission and the decision of coordinated meetings between entities such as Regional Power Committees (RPC), Central Electricity Authority (CEA), Central Transmission Utility (CTU), National/Regional Load Despatch Centres (NLDC/RLDC) and other statutory/regulatory stakeholders.

#### **Hearing on 25.06.2021**

4. Petition was admitted on 25.06.2021, and the Commission observed that the issues raised by CTUIL in the instant matter may arise in the case of other TBCB projects. Therefore, the Commission directed CTUIL to implead all the transmission



licensees implementing transmission projects under the TBCB route as respondents so that all of them may be heard and suitable directions could be issued in one order instead of deciding the issues in multiple petitions. The Commission further directed the Petitioner to implead PGCIL as a party to the proceedings. The Commission also directed STL to discuss with CTUIL and firm up the issues that may arise in the installation of OPGW in place of earth wire in various TBCB projects for smooth and proper adjudication of the issues involved.

### **Submission of Petitioner**

5. Petitioner vide affidavit dated 30.11.2021 and dated 08.03.2022 has filed an “Amended Memo of parties” impleading other transmission licensees.
6. Petitioner vide affidavit dated 08.03.2022 submitted the Minutes of Meeting dated 14.07.2021 between CTU, NRSS XXXI(B) Transmission Ltd (NTL) & Powergrid and Minutes of the Meeting held on 13.08.2021 with ISTS licensees to discuss issues related to OPGW installation on Malerkotla - Kurukshetra line & LILO of Fatehgarh – Bhadla line at Fatehgarh-II. There were divergent opinions with respect to the implementation, ownership, maintenance and operation of OPGW and no consensus was arrived at in these meetings.

### **Hearing on 10.03.2022**

7. The Commission directed CTUIL to hold a further meeting(s) with the transmission licensees and come out with a suitable proposal for smooth and proper adjudication of the issues involved.
8. The Commission directed the Petitioner to submit the list of transmission assets along with the transmission licensee’s name wherein this replacement of earth wire/ old OPGW is planned and any other issues being faced by CTUIL related to modifications required to be carried out in TBCB assets keeping in view the integrated nature of ISTS.



## Submission of Petitioner

9. Petitioner vide affidavit dated 29.03.2022 has submitted as follows:

- (a) The list of the transmission assets along with the transmission licensee's name wherein the replacement of earthwire/old OPGW is planned (as on 29/03/2022) has been submitted comprising of majority assets of Powergrid and one line Western Transmission Power Ltd (Adani).
- (b) In case the replacement of earth wire/old OPGW is planned in additional transmission assets in future, the same would be informed to the Commission by the Petitioner.
- (c) The issues (including issues other than replacement of earth wire/old OPGW) being faced by the Petitioner related to modifications required to be carried out in TBCB assets is tabulated as below:

Sr. No.	Name of Owner Utility (TBCB/JV/ IPTC)	Name of lines	Issues raised by owner Utilities/likely to arise	Comments
1.	M/s. NTL (NRSS XXXI(B) Transmission Limited) M/s Sekura Ltd.	400kV Kurukshetra – Malerkotla TL (139Km)	<ul style="list-style-type: none"> <li>a. Impact on tariff and revenue after replacement of Earthwire with OPGW (POWERGRID ownership).</li> <li>b. Handing over the Earthwire.</li> <li>c. Rectification of any damaged asset in the process of OPGW installation.</li> <li>d. Prior intimation of any work and responsible contractor.</li> <li>e. Indemnification of any outage or claimed compensation by any landowner.</li> <li>f. Ownership of OPGW and its O&amp;M.</li> <li>g. Any commercial use of OPGW.</li> </ul>	POWERGRID has communicated that it has no objection if the implementation of the laying of OPGW is undertaken by M/s Sekura NRSS XXXI(B) Transmission Ltd (STL)
2.	M/s. PKTCL (M/s. IndiGrid) (JV with POWERGRID)	<ul style="list-style-type: none"> <li>i. 400kV S/C Parbati III(HEP) – Parbati Pooling (7Km)</li> <li>ii. 400kV S/C Parbati II(HEP) – Parbati III (12Km)</li> <li>iii. 400kV Parbati Pooling – Koldam (65Km)</li> </ul>	<ul style="list-style-type: none"> <li>a. Rectification of any damaged asset in the process of OPGW installation.</li> <li>b. Return of earthwire</li> <li>c. Any commercial use of OPGW.</li> </ul>	POWERGRID has communicated that M/s PKTCL may do the installation of OPGW on their own, as discussed during the meeting with Licensees on 13.08.21.
3.	Torrent Power Limited	(i) LILO of Pirana (PG) – Pirana (T) 400kV D/c line at Ahmedabad S/s with twin HTLS along	a. Long shutdown is required for the execution of reconductoring and bay upgradation work. This may	As such no issue has been raised by owner/implementer. However, the implementation work through TBCB for bay



	<b>(TBCB)</b>	with reconductoring of Pirana (PG) – Pirana(T) line with twin HTLS conductor (ii) <b>Bay upgradation work at Pirana (PG) &amp; Pirana (T)</b>	affect the availability of other bays intermittently. b. Commercial issues may be raised by the owner for the modification.	upgradation works and reconductoring in the existing line of Torrent Power will require dismantling, breakage, and removal of existing infrastructure in the premises of Torrent Power by the new TSP.
--	---------------	--	--	--

(d) The Ministry of Power vide its Order No. 15/3/2017-Trans-Pt(1) dated 09.03.2022 has issued the “Guidelines on Planning of Communication System for Inter-State Transmission System (ISTS)”. The Guidelines define the categories of Communication System Schemes for ISTS as Category (A) and Category (B) and provide their corresponding approval procedure. The categories A and B have been defined under the Guidelines as follows: -

- **Category (A):** Communication system directly associated with new ISTS as well as incidental due to implementation of new ISTS elements (e.g. LILO of existing line on new/existing S/s where OPGW/terminal equipment are not available on the existing mainline/substations etc.)
- **Category (B):** Upgradation/modification of existing ISTS Communication system pertaining to the following:
  - Missing Links Redundancy/ System Strengthening
  - Capacity upgradation (Terminal equipment)
  - Completion of life of existing communication system elements
  - Other standalone project e.g. Cyber Security, Unified Network Management System (UNMS)
  - Adoption of New Communication Technologies

(e) Under the Guidelines, the requirement for a communication system linked with the new ISTS, shall be included in the new ISTS package and the combined proposal shall be approved as per the directions contained in MoP’s Office Order dated 28.10.2021 regarding the Re-constitution of the “National Committee on Transmission” (NCT). In the case of Category (B), Communication Schemes/Packages proposed by CTUIL for the upgradation/modification of the existing ISTS Communication System, standalone projects, and adoption of new technologies shall be put up to RPC for their views, and RPC has to provide their views on the Schemes/Packages proposed by CTUIL within 45 days of receipt of





the proposal from CTUIL. The Schemes/Packages, along with the views of RPC shall be approved by NCT. Subsequent to communication received from POWERGRID that it has no objection if the implementation of laying of OPGW is undertaken by M/s Sekura NRSS XXXI(B) Transmission Ltd (STL), the installation of OPGW on 400kV Kurukshetra-Malerkotla Transmission Line in the instant petition may be undertaken as per the procedure prescribed for category (B) communication systems under the Guidelines.

- (f) The Guidelines formulated by the Ministry of Power settle the divergent opinions with respect to implementation, ownership, maintenance and operation of OPGW between the transmission licensee and CTUIL and therefore, difficulty/disputes which are under consideration in the present Petition are not likely to recur in near future.

#### **Submission of Respondent Western Transco Power Limited (WTPL)**

10. Respondent No.18 **Western Transco Power Limited (WTPL)** vide affidavit dated 29.04.2022 has mainly submitted as under:
- (a) Respondent No. 18, Western Transco Power Limited, is a Transmission Licensee and the 765/400kV Pune (PG) (GIS) – 400kV Parli (PG) was constructed by Respondent No. 18, which was commissioned on 01.12.2013.
- (b) If the Commission allows some other party to lay OPGW on the transmission asset owned and operated by another licensee, the same would necessarily entail the following issues, which need to be considered by this Commission:
- i. The ownership of the OPGW shall remain uncertain as the transmission asset will belong to one entity, and the OPGW shall be owned by another entity.
  - ii. The OPGW which shall be installed may be utilized for commercial purposes such as communication etc., which cannot be allowed to an entity which is not the owner of the transmission asset, and the said entity cannot be permitted to make undue monetary gains by using the said asset.
  - iii. During installation of the OPGW, there may be damage to the existing asset of the Applicant.



- iv. The suitability of OPGW to the existing transmission asset is an important factor, which also requires consideration by this Commission.
  - v. Issues as regards the Right of Way (“RoW”) during the extraction of the existing wire.
  - vi. The Applicant will be liable to be compensated in case of any damage caused by the licensee during the installation of OPGW.
  - vii. Deemed availability/ compensation of financial loss in case of tripping, breakdown, maintenance etc., due to the reason not attributable to the transmission licensee which owns the transmission line in question.
  - viii. Whether O&M will be carried out by the transmission licensee which owns the transmission line in question.
11. The Commission is precluded from granting a license or permission to any other party qua a transmission asset which is owned by t Respondent No. 18.

#### **Submission of other Respondents**

12. The other Respondents NER-II Transmission LTD. (NERII), Parbati Koldam Transmission Co. LTD. (PKTCL), Gurgaon Palwal Transmission Co. LTD. (GPTL), Jabalpur Transmission Co. LTD. (JTCL), Maheshwar Transmission Co. LTD. (MTL), RAPP Transmission Co. LTD. (RTCL), Bhopal Dhule Transmission Co. LTD. (BDTCL), Odisha Generator Phase-II Transmission Co. LTD. (OGPTL), East North Interconnection Transmission Co. LTD. (ENICL), Patran Transmission Co. LTD (PTCL) and Purulia & Kharagpur Transmission Co. LTD (PKTCL), vide their individual affidavit dated 29.05.2022 have submitted the similar submission, which are as under:
- (a) The present Petitioner is obligated to comply with the provisions of Communication System Regulations, 2017, which requires the Petitioner to undertake only the planning of the communication system and not undertake installation of OPGW and communication system on the assets of the other transmission licensees.
  - (b) Section 17 of the 2003 Act has a bar on the Petitioner to acquire the transmission assets of any other licensee by any arrangement. The prayers made by the Petitioner are tantamount to the Petitioner acquiring the transmission assets of the



Respondent Licensee for installing OPGW. This is clearly stated in negative language in clause 1(a) of section 17 of the 2003 Act.

(c) The “Guidelines on Planning and Communication System for Inter State Transmission System” do not mandate the CTUIL or PGCIL to install OPGW on the transmission lines/transmission projects owned by other transmission licensees. The said Guidelines state that the proposal made by the Petitioner for the upgradation/modification of the existing ISTS communication system, etc., shall be put up to RPCs for their views.

(d) The following substantial issues arise in the present matter:

(A) Proposal may entail modification of license conditions:

- i. In the event that the Petitioner is to replace the earth wires of other transmission licensees, there may be an issue attracting license amendment, which *inter alia* requires prior permission of the Lenders. Moreover, if the ownership of OPGW is to remain with the Petitioner, then two different transmission licensees will have ownership over one TBCB asset, which will lead to complexities in terms of operation and maintenance of the asset, leveraging of the assets for another business, RoW/crop compensation, outage and availability related claims, etc.

(B) The issue of Deemed Availability.

(C) The issue of CTUIL engaging in “Other Business” under section 41 of the 2003 Act:

- i. The proposal of the Petitioner to install OPGW on the transmission assets of another Transmission Licensee entails the Petitioner to recover capital expenditure and other expenditure on installing the OPGW from the point of connection, transmission charges from the base of customers of the Petitioner.
- ii. Section 41 only allows the transmission licensee to engage in any business for “Optimum Utilization of its assets.” Therefore, under section 41 of the 2003 Act, one transmission licensee cannot engage in another business for utilization of another transmission licensee’s assets.
- iii. There is no basis in fact or in law based on which the Respondent No.1 transmission licensee or any other transmission licensee would permit the



- Petitioner or PGCIL to utilize their own transmission assets for CTUIL/PGCIL to derive revenue from installing the OPGW.
- iv. Under section 41, the Second Proviso thereto prohibits the Respondent No.1 licensee or other transmission licensees from providing their own transmission assets to CTUIL/PGCIL because that would be tantamount to encumbering its transmission assets for the loans/financial assistance that CTUIL/PGCIL would incur for the expenditure on OPGW installation.
  - v. Respondent No.1 licensee/other transmission licensees cannot be deprived of return on investment on their own transmission assets by depriving them of installing the OPGW on their own assets.

(D) The issue of Indemnification: The transmission licensees will be exposed to disputes on account of right-of-way issues with locals, outages, decrease in availability of transmission system, loss of revenue, etc., if the OPGW is installed by CTUIL/PGCIL and hence transmission licensees should be indemnified by CTUIL and/or PGCIL, as the case may be.

- (e) The dismantled earth wires will have to earn scrap value which will be amenable to treatment under the sharing of non-tariff income between the beneficiaries and LTTCs and transmission licensees. Can CTUIL nor PGCIL be permitted to replace the existing earth wires of the transmission assets of the Answering Respondent/other transmission licensees?

### **Submission of Petitioner**

- 13. Petitioner vide affidavit dated 12.05.2023 has submitted that in compliance with the directions of the Commission, a meeting was held between CTUIL & ISTS Transmission Licensees on 08.05.2023, and the minutes of the same have been submitted.

### **Hearing on 15.05.2023**

- 14. During the hearing on 15.05.2023, following has been recorded:

*"3. Learned counsel for CTUIL informed that pursuant to the direction of the Commission given in the instant petition vide Record of Proceedings dated 10.3.2022, a meeting was held between CTUIL and ISTS transmission licensees on 8.5.2023, wherein it was recorded that in the earlier meeting held on 13.8.2021, between CTUIL and the transmission licensees, it was agreed by general consensus that unless otherwise requested, the work*



regarding installation of OPGW shall be awarded to the asset owner. She further informed that a meeting was also held on 13.3.2023, amongst CTUIL, Powergrid and Sekura pursuant to the directions of the Commission vide RoP dated 10.3.2022 to discuss OPGW installation on 400 kV D/C Malerkotla- Kurukshetra line owned and operated by Sekura wherein Sekura suggested that OPGW work should be awarded to them as additional work being change in the original transmission line scope and cost of the same shall be recovered by revision in their existing TBCB tariff. Learned counsel for the CTUIL submitted that the work shall be awarded in RTM mode and tariff of the same shall be determined by the Commission as per the applicable regulations.

4. Learned counsel for Respondent No.18/WTPL submitted that while passing order in present petition, the Commission may bear in mind that the matter in issue is of Communication System and to what extent the powers under the Electricity Act, 2003 can be used in allowing revenue or in approving or determining tariff of Communication System which is not part of the transmission. In response, learned counsel for the CTUIL submitted that the Communication System is part of the transmission system CTUIL submitted that the work should be awarded in RTM mode and tariff of the same shall be determined by the Commission as per the applicable regulations.”

15. After hearing the Petitioner and Respondents, the Commission reserved the order in the matter on 15.05.2023.

**Written Submission of Respondent No. 1, SEKURA NRSS XXXI(B) Transmission Ltd**

16. Respondent No.1, **SEKURA NRSS XXXI(B) Transmission Ltd** has made written submissions dated 05.06.2023 as under:
- (a) CTUIL has proposed the following in view of MoP “Guidelines on Planning of Communication System for Inter-State Transmission System (ISTS)” dated 09.03.2022 and recent approvals of OPGW on existing lines:
- (i) OPGW installation work under ISTS Communication requirement shall be awarded to the transmission line asset owner.
  - (ii) Terminal equipment associated with OPGW cable shall be awarded to bay owner/s of the transmission line on which OPGW is proposed for installation.
- (b) A consensus has emerged that Respondent No. 1 can undertake the implementation of OPGW in the transmission assets owned by it and further that such OPGW cables will form part of its transmission assets, which ownership would also lie with Respondent No 1.
- (c) The NRSS project has been developed and operated by Respondent No. 1 as a Tariff based Competitive Bidding licensee. All transmission assets forming part of the NRSS XXXI B Project are subject to the tariff that has been arrived at pursuant to competitive bidding in accordance with the guidelines issued by the Ministry of



Power (“MOP”). Accordingly, the regime that governs the tariff of the NRSS XXXI B project falls under Section 63 of the EA 2003.

- (d) OPGW cables do not constitute a standalone asset. It is only a part of the transmission assets of a transmission licensee. The NRSS XXXI B Project is regulated under Section 63 of the EA 2003, it may not be appropriate to apply a separate regulated tariff mechanism for the upcoming OPGW cables of the NRSS XXXI B Project.
- (e) In view of the above, the OPGW cables forming part of the communication system would form an integral part of the transmission lines owned and operated by Respondent No. 1.
- (f) In the context of factoring in the implementation of the Reliable Communications Scheme in the tariff of the TBCB licensee, implementation of the Communication System as part of the NRSS XXXI B project by replacing the earth-wire with OPGW cables is an additional requirement under the mandate of law. Considering that the said requirement has cropped up after the bid deadline, the implications of the above should be considered under the Change in Law provision of the Transmission Service Agreement (TSA).
- (g) The consequences of the Change in Law and, in particular, the computation of the impact thereof upon the tariff have been set out in detail under the TSA. Considering that the TSA governs the tariff for the entire transmission assets in the NRSS project, any change in such tariff would fall within the purview of the TSA.
- (h) There is precedent for allowing additional expenditure incurred on account of a Change in Law to be passed through in the tariff. Reliance is placed on *Talwandi Sabo Power Limited vs Punjab State Electricity Regulatory Commission* [MANU/ET/0054/2020], wherein the Tribunal held that the MoEF and CC Notification constituted a Change in Law event and any additional expenditure incurred on account of the installation of flue-gas desuphurisation system was to be included as Additional Capital Cost. Reliance is also placed on the judgment of the Tribunal in *NRSS XXXI (B) Transmission Limited vs Central Electricity Regulatory Commission* [MANU/ET/0071/2021]. In this case, the Appellant has claimed compensation on account of the increase in the length of the transmission lines due to a change in the Gantry Coordinates from the one indicated in the Survey Report.



- (i) Further, vide its Final Order dated 13.05.2022 in remand proceedings in Petition no. 195MP2017, it was decided as follows:

*“16. Accordingly, NTL shall recover from LTTCs the IDC and IEDC incurred for the extended period of SCOD and compensation for the actual change in the length of the Transmission lines as against the length of the Transmission lines in case the Gantry Coordinates would have been same as indicated in the Survey Report in accordance with Article 12.2.1 of the TSA i.e. increase in non-escalable transmission charges at the rate of 0.313% for a cumulative increase of capital cost of Rs. 1.158 crore incurred up to the extended SCOD of the project.”*

- (j) Procedurally and administratively, it would be quite difficult and challenging for the TSP, CTUIL & other stakeholders involved actively in the ISTS transmission charges billing, collection & disbursement (BCD) process from a viewpoint that parts of the same transmission asset owned & operated by same Transmission Licensee would be treated under two different tariff regimes i.e. part asset under TBCB Tariff and part asset under RTM mode. The commission may please consider the single tariff regime under the available provision of the TSA for all such similar cases of OPGW laying in the existing transmission TBCB assets.

### **Analysis and Decision**

17. We have considered the submissions of the Petitioner, and Respondents and perused all relevant documents on record. The following issues arise for our consideration:

**Issue No. 1: Who shall be responsible for implementing the installation of optical ground wire (OPGW) to strengthen the communication network by replacing the earth wire on the existing transmission line owned by a transmission licensee?**

**Issue No. 2: What other factors need to be considered while such replacement is carried out, such as the impact on discovered tariff, availability, loss due to damage, etc. for the transmission licensee?**

The above issues have been dealt with in succeeding paragraphs.



**Issue No. 1: Who shall be responsible for implementing the installation of optical ground wire (OPGW), to strengthen the communication network by replacing the earth wire on the existing Transmission Line owned by a transmission licensee?**

18. Petitioner has submitted that the Reliable Communication Scheme under Central Sector for Northern Region for installation of OPGW based reliable communication system with a network size of 7248 kms (including OPGW replacement of ULDC Phase-I), by the Petitioner, was approved in the 39th Meeting of the Northern Regional Power Committee held on 2.5.2017, which was revised to 7398 Km in the 47th Meeting of the Northern Regional Power Committee held on 11.12.2019.
19. Petitioner has taken up the implementation of the project wherein OPGW is to be installed on ISTS transmission lines by replacing existing earth wire for which it has entered into a contract dated 31.1.2019 with M/s Apar Industries Ltd. (APAR) as per which dismantled earth wire shall be taken away by the contractor.
20. Petitioner has approached Respondent No.1 for installation of OPGW on the 400kV D/c Kurukshetra-Malerkotla line, which was opposed by Respondent No. 1 seeking clarifications on the regulations under which Petitioner has proposed to take away part of its asset and the ownership of new OPGW among other queries.
21. Respondent Western Transco Power Limited (WTPL) has submitted that the OPGW which shall be installed may be utilized for commercial purposes such as communication etc., which cannot be allowed to an entity which is not the owner of the transmission asset, and that the said entity cannot be permitted to make undue monetary gains by using the said asset. Further, during the installation of the OPGW, there may be damage to the existing assets of the Applicant. WTPL. Further, the concerns on Deemed availability/ compensation of financial loss in case of tripping, breakdown, maintenance, etc., due to the reason not attributable to the transmission licensee which owns the transmission line in question need to be handled besides who will carry out O&M of such OPGW.
22. The Respondents NER-II Transmission LTD. (NERII), Parbati Koldam Transmission Co. LTD. (PKTCL), Gurgaon Palwal Transmission Co. LTD. (GPTL), Jabalpur Transmission Co. LTD. (JTCL), Maheshwar Transmission Co. LTD. (MTL), RAPP Transmission Co. LTD. (RTCL), Bhopal Dhule Transmission Co. LTD. (BDTCL), Odisha Generator Phase-II Transmission Co. LTD. (OGPTL), East North





Interconnection Transmission Co. LTD. (ENICL), Patran Transmission Co. LTD (PTCL) and Purulia & Kharagpur Transmission Co. LTD (PKTCL) have opposed the replacement of earth wire by any other licensee such as Petitioner.

23. Subsequent to the filing of the instant Petition, several rounds of meetings were undertaken by CTUIL with transmission licensees wherein consensus emerged during the meetings held on 13.3.2023 and 8.5.2023 regarding modalities for implementation of OPGW raised in the instant Petition.
24. We have considered the submissions of the Petitioner and Respondents and have also perused the facts on record.
25. The relevant extracts of the 39<sup>th</sup> Meeting of the NRPC held on 2.5.2017, and 47<sup>th</sup> Meeting of the NRPC held on 11.12.2019 are as under:

### **39<sup>th</sup> Meeting of the NRPC held on 2.5.2017**

*"NRPC Deliberations*

*B.6 Reliable Communication Scheme under Central Sector for Northern Region*

*B.6.7 NRPC approved the proposal by POWERGRID for installation of 5474 kms. of OPGW based communication scheme, at an estimated cost of Rs.137 Crs."*

*"B.17 Replacement of OPGW installed under ULDC Phase-I*

*B.17.6 POWERGRID informed that 24-F OPGW would be considered as per the existing philosophy and along with communication equipment for which the estimated cost would be Rs.59 Crs. The scheme would become part of existing Commercial Agreement signed for ULDC Project and would be implemented as part of Reliable Communication Scheme under Central Sector for Northern Region.*

*B.17.7 After detailed deliberations NRPC approved the proposal of replacement of old OPGW installed under ULDC phase-I..."*

### **47<sup>th</sup> Meeting of the NRPC held on 11.12.2019**

*"B.6.4 After detailed deliberations, the following links were agreed upon:*

<i>Sl. No.</i>	<i>Name of Link</i>	<i>Route Length (km)</i>	<i>Purpose</i>
<i>1</i>	<i>400kV Panchkula-Patiala</i>	<i>65.494</i>	<i>Physical Path Redundancy &amp; route diversity for Panchkula S/s</i>
<i>2</i>	<i>400kV Jalandhar Moga</i>	<i>85.15</i>	<i>Physical Path Redundancy &amp; route diversity for Jalandhar (PG) through Central Sector links.</i>
<i>3</i>	<i>400kV Parbati PS - Amritsar</i>	<i>250.53</i>	<i>Path Redundancy &amp; route diversity of Parbati PS (Banala) &amp; Hamirpur 4 through Central sector network.</i>
<i>4</i>	<i>LILO of Parbati - Amritsar at Hamirpur</i>	<i>6.7</i>	



5	400kV Kurukshetra-Malerkotla PG	180	Path Redundancy of Malerkotla (PG) through central sector network.
6	765kV Meerut - Moga	337.15	Route diversity of Moga S/S & creation of reliable ICCP link between Punjab, Rajasthan (through upcoming 765kV Bikaner Moga under GEC Part D & NRLDC).
7	400kV Dehradun-Bagpat	165	Physical path Redundancy & for route diversity of Bagpat S/S
8	400kV RAPP B -Jaipur South with LILO at Kota	226	Redundancy of Kota & RAPP through Central Sector network
9	400kV Allahabad-Singrauli	200	Redundancy of Singrauli
10	400kV Allahabad-Fatehpur 765	130	Strengthening of Inter Regional Connectivity (WR-NR). (400kV Fatehpur – Mainpuri is under implementation under Reliable Communication scheme)
11	400kV Kanpur - Ballabgarh	370	Redundancy of old Agra-Kanpur link which has reached the end of its useful life of 15 years.
12	Chittorgarh 400kV RVPN to Chittorgarh 220kV RVPN	07	Redundancy of Chittorgarh 220/132 through Central Sector network
13	400kV Lucknow – Kanpur	156	Redundancy of Network and avoiding multiple sub-stations
	TOTAL	2179.024	

B.6.5 POWERGRID further informed that in accordance with 39<sup>th</sup> & 40<sup>th</sup> NRPC meeting, implementation of 7248 Km OPGW is under execution. POWERGRID also informed that around 2031 km OPGW network is not coming up in the original reliable scheme (as approved in 39<sup>th</sup> NRPC) as some of the IPPs are not coming up and also connectivity for some were covered in different schemes. Considering the same and additional requirement of 2180 km as proposed for taking care of contingencies as per Communication Planning Criteria, the overall network size approved in 39<sup>th</sup> & 40<sup>th</sup> NRPC will increase by only 150 km considering new requirement of 2180 km in lieu of 2031km network not coming up as brought out above.

B.6.6 Accordingly, TeST sub-committee members have agreed for the implementation of 2180 Km of OPGW network under on-going Reliable Communication Project (7248 km) so that the same can be implemented within the same time period. The revised network size of Reliable Communication Project will become 7398 Km.

B.6.7 TCC recommended for the approval of the modified scheme as agreed by TeST subcommittee.

#### **NRPC Deliberations**

B.6.8 NRPC concurred with TCC deliberations.”

As per the above, the proposal of the petitioner for the installation of OPGW based communication network for Reliable Communication Scheme under the Central Sector for Northern Region was approved in 39<sup>th</sup> Meeting of NRPC held on 02.05.2017 and 47<sup>th</sup> Meeting of NRPC held on 11.12.2019, wherein the installation of OPGW on 400kV Kurukshetra - Malerkotla line (180km) by replacing the earth wire was agreed in 47<sup>th</sup> meeting of the NRPC.



26. Clauses 7.1.1 and 7.1.2 of the Transmission Service Agreement dated 02.01.2014 of Respondent No.1, as submitted by the Petitioner, provide as under:

***“7. OPERATION AND MAINTENANCE OF THE PROJECT***

*7.1.1 The TSP shall be responsible for ensuring that the Project is operated and maintained in accordance with the Indian Electricity Grid Code (IEGC)/State Grid Code (as applicable), Transmission License, directions of National Load Despatch Centre/RLDC/SLDC (as applicable), Prudent Utility Practices, other legal requirements including the terms of Consents, Clearances and Permits and is made available for use by the Transmission Customers as per the provisions of applicable regulations including but not limited to the Central Electricity Regulatory Commission (Open Access in Inter-state Transmission) Regulations, 2004, Central Electricity Authority (Installation and Operation of Meters) Regulations, 2006, and the Central Electricity Authority Grid Standards of Operation and Maintenance of Transmission Lines (as and when it comes into force) as amended from time to time and provisions of this Agreement.*

*7.1.2 The TSP shall operate and maintain the Project in an efficient, coordinated and economical manner and comply with the directions issued by the National Load Despatch Centre, RLDC or the SLDC, as the case may be, in line with the provisions of the Electricity Act 2003 and Rule 5 of the Electricity Rules, 2005, and as amended from time to time.”*

As per the above, the TSP (i.e. Transmission licensee) is responsible for ensuring the operation and maintenance of the project in an efficient, coordinated and economical manner and in compliance with the Indian Electricity Grid Code (IEGC)/State Grid Code (as applicable), Transmission License, directions of National Load Despatch Centre/RLDC/SLDC (as applicable), Prudent Utility Practices, other legal requirements.

Further, the “Prudent Utility Practices” defined in the TSA are as under:

**“Prudent Utility Practices”** shall mean the *practices, methods and standards that are generally accepted internationally from time to time by electric transmission utilities for the purpose of ensuring the safe, efficient and economic design, construction, commissioning, operation, repair and maintenance of the Project and which practices, methods and standards shall be adjusted as necessary, to take account of:*

- (i) operation, repair and maintenance guidelines given by the manufacturers to be incorporated in the Project,*
  - (ii) the requirements of Law, and*
  - (iii) the physical conditions at the Site*
- .....”*

As per the above, the TSP (i.e. Transmission licensee) is obligated to adopt the practices, methods and standards that are generally accepted internationally from time to time by electric transmission utilities for the purpose of ensuring the safe, efficient and economic design, construction, commissioning, operation, repair and maintenance of the Project and to take into account the guidelines given by the manufacturers, requirements of law and physical conditions at the site.



27. Regulation 7.2 of the Communication System Regulations, 2017, provides as under:

*“7.2 Role of CTU (i) The CTU shall in due consideration of the planning criteria and guidelines formulated by CEA, be responsible for planning and coordination for development of reliable National communication backbone Communication System among National Load despatch Centre, Regional Load Despatch Centre(s) and State Load Despatch Centre(s) and REMCs along with Central Generating Stations, ISTS Sub - Stations, UMPPs, inter-State generating stations, IPPs, renewable energy sources connected to the ISTS, Intra-State entities, STU, State distribution companies, Centralised Coordination or Control Centres for generation and transmission. While carrying out planning process from time to time, CTU shall in addition to the data collected from and in consultation with the users consider operational feedback from NLDC, RLDCs and SLDCs.*

*(ii) The CTU shall plan the communication system comprehensively and prospectively for users considering the requirement of the expected nodes in consultation with Standing Committee to be constituted by CEA.”*

As per the above, CTUIL shall be responsible for planning and coordination for the development of a reliable National communication backbone Communication System among the National Load despatch Centre, Regional Load Despatch Centre(s) and State Load Despatch Centre(s) and REMCs along with Central Generating Stations, ISTS Sub -Stations, UMPPs, inter-State generating stations, IPPs, renewable energy sources connected to the ISTS, Intra-State entities, STU, State distribution companies, Centralized Coordination or Control Centres for generation and transmission.

28. Clause (aa) of Regulation 2(i) and Regulation 7.8 of the Communication System Regulations, 2017, provide as under:

*“2(i) aa) “User” means a person such as a Generating Company including Captive Generating Plant, RE Generator, Transmission Licensee [other than the Central Transmission Utility (CTU) and State Transmission Utility (STU)], Distribution Licensee, a Bulk Consumer, whose electrical system is connected to the ISTS or the intra-State transmission system.*

.....

*7.8 Role of Users:*

*(i) The Users including renewable energy generators shall be responsible for provision of compatible equipment along with appropriate interface for uninterrupted communication with the concerned control centres and shall be responsible for successful integration with the communication system provided by CTU or STU for data communication as per guidelines issued by NLDC.*

*(ii) Users may utilize the available transmission infrastructure for establishing communication up to nearest wideband node for meeting communication requirements from their stations to concerned control centres.*

*(iii) The Users shall also be responsible for expansion /up-gradation as well as operation and maintenance of communication equipment owned by them.”*



As per the above, Users, inter-alia including transmission licensee, may utilize the available transmission infrastructure for establishing communication up to the nearest wideband node for meeting communication requirements and shall also be responsible for expansion /up-gradation as well as operation and maintenance of communication equipment owned by them.

29. Regulation 26(1) of the Communication Standards Regulations, 2020 provides as under:

**“26. Requirements of fibre optic communication.** (1) All wideband communications shall be established using fibre optic communication consisting of underground fibre optic cable, optical ground wire (OPGW) or underground fiber optic cable (UGFO) and all dielectric self supporting (ADSS).”

As per the above, all wideband communications shall be established using fibre optic communication.

30. The Guidelines on Planning of Communication System for Inter-State Transmission System (ISTS) issued by MoP on 09.03.2022 provides as under:

**“Guidelines on Planning of Communication System for Inter-State Transmission System (ISTS)**

### **1. Introduction**

*In order to achieve safe, secure, stable and reliable operation of the grid as well as its economical and integrated operation, communication system plays a critical role. The communication system may be treated as an integral part of the transmission system. Therefore, it is imperative to carry out the planning for Communication System in Power Sector.*

*For planning, and coordination for development of communication system for inter-State transmission system, Central Transmission Utility is designated as the nodal agency.*

*Ministry of Power has formulated this guidelines named as “Guidelines on Planning of Communication System for Inter-State Transmission System (ISTS)”. This guidelines defines the categories of Communication System Schemes for ISTS and their corresponding approval procedure.*

### **2. Objective**

*Considering the critical role of Communication System in ISTS, a separate guidelines for its planning is essential. This guideline on Planning of Communication System for Inter-State Transmission System (ISTS) is being formulated with the objective to help in efficient, coordinated, smooth, economical and uniform planning of Communication System for ISTS.*

### **3. Applicability**

*i. This guideline shall come into force from the date of its issuance by the Ministry of Power.*

*ii. The guidelines shall be applicable for communication system for ISTS only.*

### **4. Categorization of Communication Schemes/Packages**



Communication Schemes/Packages under this policy are categorized as Category (A) and Category (B). The description of categories is as under:-

**Category (A):** Communication system directly associated with new ISTS as well as incidental due to implementation of new ISTS elements (e.g. LILO of existing line on new/existing S/s where OPGW/terminal equipment are not available on the existing main line/substations etc.)

**Category (B):** Upgradation/modification of existing ISTS Communication system pertaining to following:

- Missing Links
- Redundancy/ System Strengthening
- Capacity upgradation (Terminal equipment)
- Completion of life of existing communication system elements
- Other standalone project e.g. Cyber Security, Unified Network Management System (UNMS)
- Adoption of New Communication Technologies

#### **5. Procedure for approval of Communication Schemes/Packages**

**Category (A):** As planning of ISTS Communication System is an integral part of planning of new Inter-State Transmission System, the requirement for communication system linked with new ISTS shall be included in new ISTS package and combined proposal shall be approved as per the directions contained in MoP office order dated 28.10.2021 regarding Re-constitution of the “National Committee on Transmission” (NCT).

Further, Communication requirements which are incidental due to implementation of new ISTS elements (e.g. LILO of existing line on new/existing S/s where OPGW/Terminal Equipment are not available on the existing main line/substations etc.) are also to be approved alongwith that of respective transmission system package.

#### **Category (B):**

Communication Schemes/Packages proposed by CTUIL for upgradation/modification of existing ISTS Communication System, standalone projects, adoption of new technologies shall be put up to RPC for their views. RPC to provide their views on the Schemes/Packages proposed by CTUIL within 45 days of receipt of the proposal from CTUIL.

The Schemes/Packages alongwith the views of RPC shall be approved by NCT.

6. Communication system shall be planned in accordance with Central Electricity Authority (Technical Standards for Communication System in Power System Operations) Regulations, Central Electricity Regulatory Commission (Communication System for inter-State transmission of electricity) Regulations, Manual of Communication System Planning in Power System Operation published by Central Electricity Authority and other relevant regulations/guidelines/orders/policies issued by Government of India for development of reliable communication system for the power system.”

As per the above, Communication Schemes shall be proposed by CTUIL for the upgradation/modification of the existing ISTS Communication System, standalone projects, and adoption of new technologies, respectively.

31. We observe that the modalities of implementation of the said OPGW by the existing transmission licensee or POWERGRID are not covered specifically in the MOP



Communication Guidelines. However, on the direction of the Commission, Petitioner has convened meetings on 14.07.2021,13.08.2021,13.03.2023 and 8.05.2023 with the ISTS licensees to come out with a suitable proposal for smooth and proper adjudication of the issues involved. Consensus for the installation of OPGW by replacing the existing earth wire has been reached in the meetings held on 13.03.2023 and 08.05.2023. The relevant extracts of the same are as follows :

**Minutes of the Meeting held on 13.03.2023 between CTU, POWERGRID &NRSS XXXI (B) Transmission Ltd./ Sekura**

“ .....

3. CTU added that a compliance affidavit was submitted before CERC after receiving communication from POWERGRID that it has no objection if the implementation of laying of OPGW is undertaken by M/s NRSS XXXI (B) Transmission Ltd. / Sekura on its 400kV D/C Malerkotla - Kurukshetra line. Subsequently M/s NRSS XXXI (B) Transmission Ltd. / Sekura submitted a proposal to CTU via letter dtd. 23.01.2023 for OPGW installation on its 400kV Malerkotla - Kurukshetra line as well as on 400kV Malerkotla – Amritsar line of 48F OPGW on both the lines.
4. CTU further informed that after reviewing the proposal of M/s NRSS XXXI (B) Transmission Ltd. / Sekura, the 400kV D/C Malerkotla – Amritsar line was not found to be required at present for OPGW installation. Moreover, the OPGW fibre capacity of 24F is sufficient at present. In view of this CTU has put up an agenda in 63rd NRPC for OPGW installation on the 400kV D/C Malerkotla - Kurukshetra line with 24F OPGW. NRPC after deliberations, was of the view that Hon'ble CERC should be apprised about the proposal before reviewing in RPC and getting approved in NCT. If M/s NRSS XXXI (B) Transmission Ltd. / Sekura wants to install OPGW on its 400kV D/C Malerkotla – Amritsar line and 48F in place of 24F in both 400kV D/C Malerkotla - Kurukshetra line & 400kV D/C Malerkotla – Amritsar line, the cost of the OPGW with 48F on 400kV Malerkotla – Amritsar line and additional fibers of 400kV D/C Malerkotla - Kurukshetra line shall be borne by the M/s NRSS XXXI (B) Transmission Ltd. / Sekura.
5. CTU further stated that the various issues raised earlier by M/s NRSS XXXI (B) Transmission Ltd. / Sekura viz., impact on tariff and revenue after replacement of earthwire with OPGW (POWERGRID Ownership), handing over the earth wire to POWERGRID, rectification of any damaged asset in the process of OPGW installation, prior intimation & work planning of OPGW laying work and; details of responsible contractor, indemnification on of any outage or claimed compensation by any landowner, issue related to the ownership of the OPGW and its O&M, and issue related to any commercial use of OPGW etc. shall get resolved as the OPGW laying work shall be awarded to NRSS XXXI (B) Transmission Ltd. / M/s Sekura after NCT approval under RTM mode, and M/s Sekura being the Owner of this ISTS transmission line the ownership of this OPGW would also remain with them.
6. NRSS XXXI (B) Transmission Ltd. / M/s Sekura suggested that this OPGW work shall be awarded to them as additional work by change in the original transmission line scope and cost of the same shall be recovered by revision in their existing TBCB tariff. However, CTU stated that as the TBCB asset has already lived its prominent life so this work shall be awarded in RTM mode and tariff of the same shall be determined by the applicable RTM regulations of CERC.
7. CTU stated that deliberations of this meeting shall be communicated to CERC as part of Petition no. 94/MP/2021.



.....”

As per the above, NRSS XXXI(B) Transmission Ltd / M/s Sekura suggested installing 48 F OPGW in place of 24 Fibre suggested by CTUIL. Further, Sekura suggested that OPGW work may be awarded to them as additional work by a change in the original transmission line scope, and the cost of the same may be recovered by a revision in their existing TBCB tariff. However, CTU stated that this work shall be awarded in RTM mode, and the tariff of the same may be determined as per RTM regulations of CERC. Further, CTU also stated that various issues raised earlier by M/s NRSS XXXI (B) Transmission Ltd. / M/s Sekura shall also be resolved by awarding the OPGW work to them.

### **Minutes of the Meeting held between CTU & ISTS Transmission Licensees on 08.05.2023**

*“7. With reference to above ROP and MOP guidelines, CTU proposed below mentioned methodology for deliberation during the meeting:*

Sr. No.	CTUIL proposal for deliberations
(i)	<p><i>In view of MoP “Guidelines on Planning of Communication System for Inter-State Transmission System (ISTS)” dtd. 09.03.2022 and recent approvals of OPGW on existing lines, following is proposed:</i></p> <p><b><i>(i) OPGW installation work under ISTS Communication requirement shall be awarded to the transmission line asset owner.</i></b></p> <p><b><i>(ii) Terminal equipment associated with OPGW cable shall be awarded to bay owner/s of the transmission line on which OPGW is proposed for installation.</i></b></p> <p><i>If the Asset owners refuses the work same shall be deliberated in the NCT and awarded to other party with consent of existing asset owner/s.</i></p>
(ii)	<p><i>Other views of Transmission licensees on the above</i></p>

*8. Sekura agreed for the methodology put up by CTU, however they raised the concern of provision of Fibre Optic Terminal equipment (FOTE) at bays level for their line, 400kV Kurukshetra- Malerkotla. POWERGRID confirmed they shall provide FOTE as the bays are owned by them as suggested by CTU.*

*9. Indigrd enquired about the modalities of using OPGW for ISTS communication which is provided by the TSP which was not originally in the scope of RFP of a transmission line. CTU informed that such issues shall be dealt on case-to-case basis in the RPC forum, in view of ISTS system requirement.*

*10. Other licenses also agreed to the CTU proposal.*

.....”

As per the above, it was agreed that OPGW installation work under ISTS Communication requirement might be awarded to the transmission line asset





owner, and if the asset owners refuse the work, same may be deliberated in the NCT and awarded to another party with the consent of existing asset owner(s).

32. We observe that Communication systems are essential to facilitate secure, reliable and economic operation of the grid and are an important pre-requisite for the efficient monitoring, operation and control of the power system CTU, has been entrusted with the responsibility of planning and coordination for the development of an efficient and coordinated communication system on a regional basis to provide a backbone communication system for the ISTS under various Regulations of CEA and CERC and Guidelines of MOP.

33. We observe that during the meetings held on 13.03.2023 and 8.5.2023, Petitioner CTUIL and Respondent No.1 Sekura have agreed on the modalities of implementation of OPGW on instant transmission asset of Malerkotla-Kurukshetra line. Further, during the hearing on 15.05.2023, CTUIL based on the meeting held on 08.05.2023 between CTU and various transmission licensees, submitted that the OPGW work may be awarded to the transmission line asset owner. Accordingly, the work of replacement of earth wire under instant case may be allowed to be executed by the transmission licensee owning such earth wire following the required procedure with the approval of the competent authority.

**Issue No. 2: What other factors need to be considered while such replacement is carried out, such as impact on discovered tariff, availability, loss due to damage etc, for the Transmission licensee?**

34. During the Meeting held on 13.03.2023 and during a hearing on 15.05.2023, CTU has submitted that the work may be awarded in RTM mode and the tariff of the same may be determined by the Commission as per the applicable regulations.

35. Respondent No.1 has submitted that the implementation of the Communication System by replacing the earth-wire with OPGW cables is an additional requirement under the mandate of law, and the same may be considered under the Change in Law provision of the Transmission Service Agreement (TSA). Further, the consequences of Change in Law and, in particular, the computation of the impact thereof upon the tariff have been set out in detail under the TSA, and any change in tariff would fall within the purview of the TSA.

36. We observe that installation of OPGW is a requirement which has emerged at a stage after the TBCB project has been declared commercial. Further, we observe that the tariff of the TBCB Project is governed in terms of TSA and are of the view that appropriate compensation needs to be provided for recovery of additional expenditure towards OPGW installation and its maintenance by the licensee.
37. We have perused the TSA signed on 02.01.2014 between NRSS XXXI (B) Transmission Limited and LTTCs, submitted in another Petition No. 89/TT/2014, which provides the treatment of Change in Law as under:

**“12 CHANGE IN LAW**

**12.1 Change in law**

12.1.1 *Change in law means the occurrence of any of the following after the date, which is seven (7) days prior to the Bid Deadline resulting into any additional recurring/ non – recurring expenditure by the TSP or any income to the TSP:*

- *The enactment, coming into effect, adoption, promulgation, amendment, modification or repeal (without re-enactment or consolidation ) in India, of any Law, including rules and regulations framed pursuant to such Law;*
- *a change in the interpretation or application of any Law by any Indian Governmental Instrumentality having the legal power to interpret or apply such Law, or any Competent Court of Law;*
- *the imposition of a requirement for obtaining any Consents, Clearances and Permits which was not required earlier;*
- *a change in the terms and conditions prescribed for obtaining any Consents, Clearances and Permits or the inclusion of any new terms or conditions for obtaining such Consents, Clearances and Permits;*
- *any change in the licensing regulations of the Appropriate Commission, under which the Transmission License for the Project was granted if made applicable by such Appropriate Commission to the TSP;*
- *any change in the Acquisition Price; or*
- *any change in tax or introduction of any tax made applicable for providing Transmission Service by the TSP as per the terms of this Agreement*

.....  
**12.2 Relief for Change in Law**

**12.2.1 During Construction Period**

*During the Constriction Period, the impact of increase/decrease in the cost of the Project in the Transmission Charges shall be governed by the formula given below:*

- *For every cumulative increase/decrease of each Rupees One Crore Fifteen Lakhs Eighty Thousand Only (Rs. 1.158 Cr) in the cost of the Project up to the Scheduled COD of the Project, the increase/decrease in Non-Escalable Transmission Charges shall be an amount equal to Zero Point Three One Three percent (0.313%) of the Non-Escalable Transmission Charges.*

**12.2.2 During the Operation Period:**

*During the Operation Period, the compensation for any increase/decrease in revenues shall be determined and effective from such date, as decided by the Appropriate Commission whose decision shall be final and binding on both the Parties, subject to rights of appeal provided under applicable Law.*

*Provided that the above mentioned compensation shall be payable only if the increase/decrease in revenues or cost to the TSP is in excess of an amount equivalent to one percent (1%) of Transmission Charges in aggregate for a Contract Year.*



12.2.3 For any claims made under Articles 12.2.1 and 12.2.2 above, the TSP shall provide to the Long Term Transmission Customers and the Appropriate Commission documentary proof of such increase/decrease in cost of the Project/ revenue for establishing the impact of such Change in Law.

12.2.4 The decision of the Appropriate Commission, with regards to the determination of the compensation mentioned above in Articles 12.2.1 and 12.2.2, and the date from which such compensation shall become effective, shall be final and binding on both the Parties subject to rights of appeal provided under applicable Law.”

We observe that the instant case of replacement of earth wire with OPGW is a work which was not part of the original scope of TSA. Since the OPGW has not been provided with a separate transmission licence, we are not inclined to consider the suggestion of CTU to consider the instant work of replacement under RTM. We observe that TSA provides for treatment of additional expenditure under “Change in Law”. We are of the considered view that additional expenditure on account of the replacement of earth wire after adjusting the buy-back or the scrap value of that earth-wire shall be treated in the manner as expenditure under Change in Law so that its recovery is simplified. The transmission licensee is directed to follow a transparent process of competitive bidding while implementing such work. After implementation of the work, the transmission licensee is required to approach the Commission for approval of such expenditure along with audited data of the expenditure and details of competitive bidding carried out by it. The transmission licence shall not be required to be amended to include OPGW since the transmission licence issued to Respondent No.1 does not specifically provide the specification of earth wire, and OPGW shall be considered within the same transmission licence.

38. Further regarding the treatment of deemed availability for the period when such replacement is carried out, we have perused the TSA signed on 02.01.2014 between NRSS XXXI (B) Transmission Limited and LTTCs, submitted in another Petition No. 89/TT/2014, which provides the provision for availability of the project as under:

**“8 AVAILABILITY OF THE PROJECT**

**8.1 Calculation of Availability of the Project:**

*Calculation of Availability for the Elements and for the Project, as the case may be, shall be as per Appendix IV of the Central Electricity Regulatory Commission (Terms and Conditions of Tariff) Regulations, 2009, as applicable seven (7) days prior to the Bid Deadline and as appended in Schedule 9.*

.....



**Schedule 9**

*Appendix IV of Central Electricity Regulatory Commission (Terms and Conditions of Tariff) Regulations, 2009*

**Procedure for Calculation of Transmission System Availability Factor for a Month**

.....  
5. The transmission elements under outage due to following reasons shall be deemed to be available:

i. Shut down availed for maintenance or construction of elements of another transmission scheme. If the other transmission scheme belongs to the transmission licensee, the Member-Secretary, RPC may restrict the deemed availability period to that considered reasonable by him for the work involved.

ii. Switching off of a transmission line to restrict over voltage and manual tripping of switched reactors as per the directions of RLDC.

.....”

As per the above, the transmission elements under outage due to shutdown availed for maintenance or construction of elements of another transmission scheme, which may be of the same transmission licensee also, shall be deemed to be available. Hence the issue of deemed availability shall be handled accordingly.

39. Considering the above we are of view that the treatment of deemed availability during the period of OPGW installation work by replacing the exiting earth wire, shall be treated in terms of the provisions under TSA.

40. CTUIL is directed to follow similar principles for facilitating and allowing OPGW installation by other transmission licensees.

41. The Petition No. 94/MP/2021 is disposed of in terms of the above.

Sd/  
**(P. K. Singh)**  
Member

Sd/  
**(Arun Goyal)**  
Member

Sd/  
**(I. S. Jha)**  
Member

Sd/  
**(Jishnu Barua)**  
Chairperson





भारत सरकार  
**Government of India**  
 विद्युत मंत्रालय  
**Ministry of Power**  
 उत्तर क्षेत्रीय विद्युत समिति  
**Northern Regional Power Committee**

सं. उक्षेविस/वाणिज्यिक/209/आरपीसी/69 वीं/2023/

दिनांक: 01.11.2023

सेवा में/To,

उ.क्षे.वि.स. के सभी सदस्य एवं विशेष आमंत्रित (संलग्न सूचीनुसार)  
 Members of NRPC & Special Invitees (As per List)

**विषय: उत्तर क्षेत्रीय विद्युत समिति की 69 वीं बैठक का कार्यवृत्त।**  
**Subject: Minutes of 69<sup>th</sup> meeting of Northern Regional Power Committee.**

महोदय/महोदया,

उत्तर क्षेत्रीय विद्युत समिति की 69 वीं बैठक दिनांक **27.09.2023 (10:30 AM)** को वीडियो कॉन्फ्रेंसिंग के माध्यम से आयोजित की गयी थी। बैठक का कार्यवृत्त संलग्न है। यह उ.क्षे.वि.स. की वेबसाइट (<http://164.100.60.165/>) पर भी उपलब्ध है।

The 69<sup>th</sup> meeting of Northern Region Power Committee (NRPC) was held on **27.09.2023 (10:30 AM)** via video conferencing. MoM of the same is attached herewith. The same is also available on NRPC Sectt. Website (<http://164.100.60.165/>).

भवदीय  
 Yours faithfully

Signed by Vijay Kumar  
 Singh

Date: 03-11-2023 13:18:20

(वी.के. सिंह)  
 Reason: Approved  
 (V.K. Singh)

सदस्यसचिव  
 Member Secretary

प्रतिलिपि: मोहम्मद शायिन, एमडी, एचवीपीएनएल एवं अध्यक्ष, एनआरपीसी ([md@hvpn.org.in](mailto:md@hvpn.org.in))

- A.4.8** CTUIL proposed that DTL may expedite the implementation of 400/220kV Goplapur Sub-station and POWERGRID/DTL may explore the space availability for 400/220kV ICT augmentation at Maharani Bagh S/s (Sec-2) as DTL also owned 08 Nos 220kV System at Maharani Bagh S/s.
- A.4.9** CTUIL also suggested that in the meantime DTL may explore load segregation at Maharani Bagh Sub-station so as to contain ICT loadings in solar maximized scenario for 2024-25 & beyond till availability of Gopalpur S/s.
- A.4.10** There was no representative from DTL or SLDC, Delhi in the meeting. Chairperson, NRPC expressed concern on absence of DTL representatives.
- A.4.11** GM, NRLDC mentioned that no commissioning schedule is made available with NRLDC for this scheme. He further commented that presently 220kV bus sectionalizer is closed at Maharani Bagh Sub-station, therefore there is no N-1 compliance issue now.
- A.4.12** GM, CTUIL highlighted about commissioning of proposed Narela Sub-station which will lead to enormous loading at Maharani Bagh Sub-station. He expressed concern that the Gopalpur project is still under tendering stage even after 7 years from proposal.
- A.4.13** CGM, POWERGRID opined that space constraint at Maharani Bagh Sub-station may be solved by replacing 125 MVar reactor with new 500 MVA ICT, since due to good loading pattern there is no such issue of high voltage at Maharani Bagh Sub-station.
- A.4.14** In view of absence of DTL representatives, forum deferred the agenda and agreed to discuss separately.

***Decision of the Forum:***

*Forum decided that a separate meeting may be convened by NRPC secretariat with DTL, POWERGRID, CEA, NRLDC and CTUIL to resolve the issue.*

**A.5 OPGW installation on existing 400 kV Kota – Merta line which is LILOed at Shri Cement & proposed to be LILOed at 765/400 kV Beawar (ISTS) S/s (agenda by CTUIL)**

- A.5.1. EE (P), NRPC apprised that 400 kV Kota – Merta line (256kms) was constructed without OPGW by POWERGRID and this line is also LILOed at Shri Cement (Captive Merchant Generator). LILO portion of approx. 55 kms. was constructed by M/s Shri Cement. This line is further proposed to be LILOed at 765/400 kV Beawar

(ISTS) S/s under TBCB scheme “Transmission system for evacuation of power from REZ in Rajasthan (20 GW) Phase III –Part F”, where OPGW has been considered on LILO portion & FOTE at Bewar under TBCB scheme. Connectivity of Shri-Cement and Bewar (ISTS) is as below:

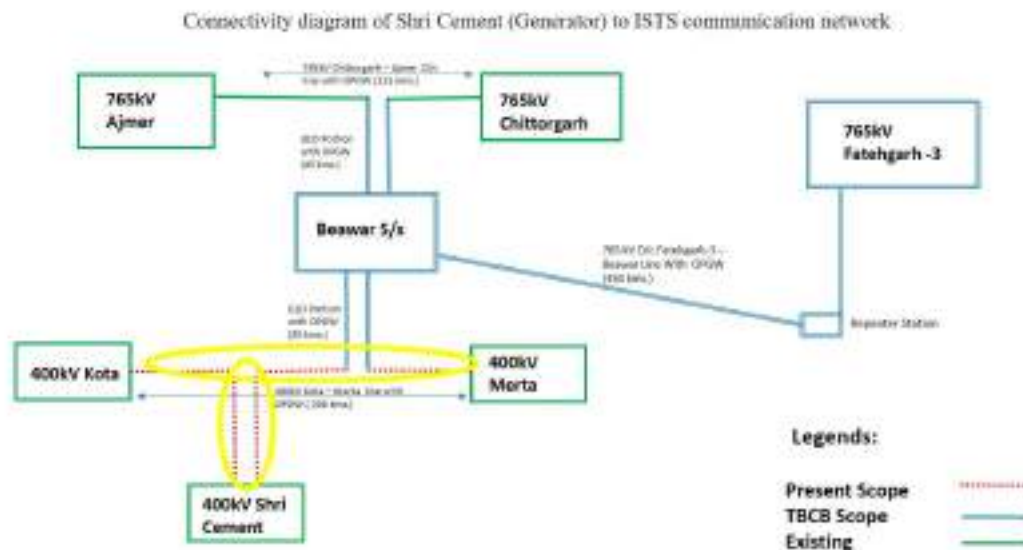

- A.5.2. As stated by Grid-India, data of Shri Cement is intermittent due to GPRS/ PLCC connectivity at present. Hence Grid-India has requested CTU to plan OPGW based connectivity for the same. Moreover, Grid-India further mentioned that in future PMUs may also be planned for Shri Cement station under URTDSM Ph-II project. As PMU data transmission on GPRS/PLCC connectivity is not sufficient therefore OPGW based communication shall also be required to send the PMU/SCADA/AMR data to NRLDC in a secured & reliable manner.
- A.5.3. The agenda for OPGW installation on 400 kV Kota – Merta line (256kms.) along with OPGW installation on LILO portion of Shri Cement terminal equipment was discussed in the 57<sup>th</sup> NRPC meeting held on 31.08.2022. In the same meeting, OPGW installation was agreed for the 400 kV Kota – Merta line (256kms.) costing approximately 11.5 Crs. However, no consensus was made for the OPGW installation on LILO portion of Shri Cement (55 kms) costing approx. 2.5 Crs. NRPC forum further stated that decision regarding laying of OPGW in the Sri Cement LILO portion may be taken in the upcoming NRPC meetings after inputs received from Shree Cement.
- A.5.4. The proposal was taken up in the 11<sup>th</sup> NCT meeting held on 28.12.2022 & 17.01.2023, for OPGW installation on 400 kV Kota – Merta line (256kms.) excluding

LILO portion of Shri-Cement, wherein NCT opined that implementation of OPGW while bypassing LILO at Shree Cement is not desirable.

- A.5.5. The agenda was put up again by CTU in the 64<sup>th</sup> NRPC meeting held on 24.03.2023, where NRPC forum stated that a separate meeting shall be convened by them with CTU, Sri Cement & NRLDC for reviewing Shri Cement connectivity.
- A.5.6. NRPC Secretariat called the meeting on 01.09.2023 among CTU, NRLDC & Shri Cement. In the meeting Shri Cement stated that as a small generator, it is difficult for them to bear OPGW cost. Further they stated that OPGW connectivity for some of the private IPPs e.g. Budhil, Soreng, AD Hydro, Karcham Wangtoo were previously done under ISTS schemes in sharing tariff mechanism. In similar way Shri Cement connectivity shall also be provided. MS, NRPC requested CTU to put up the agenda in the upcoming NRPC meeting along with the details of approval of OPGW for Budhil, Soreng, AD Hydro, Karcham- Wangtoo generators.
- A.5.7. CTUIL mentioned that in the 39<sup>th</sup> & 40<sup>th</sup> NRPC meeting held on 02.05.2017 & 28.10.2017 respectively, the OPGW system was approved for Budhil, Soreng, AD Hydro, Karcham- Wangtoo IPPs under ISTS in reliable communication scheme of Northern Region being implemented by POWERGRID in RTM mode (the relevant extracts of MoM of stated NRPC meetings are attached as **Annexure -III**).
- A.5.8. CTUIL representative consented that based on deliberation in separate meeting on 01.09.2023, the agenda may be approved in pursuance to similar decision taken for for Budhil, Soreng, AD Hydro, Karcham- Wangtoo IPPs earlier.
- A.5.9. POWERGRID representative informed about change in cost for the OPGW installation from 11.5 Crs. to approximately 15 Crs. for 400 kV Kota – Merta line (256kms) and from 2.5 crs. to approximately 3.5 Crs. for LILO portion of Shri Cement (55 kms).

***Decision of the Forum:***

*Forum accorded approval to proposal of CTUIL for OPGW installation on LILOed portion of existing 400 kV Kota – Merta line at Shri Cement under RTM.*

- A.6 Allotment of 315MVA ICT available as regional spare at POWERGRID Ludhiana Sub-station to RVPN's 400kV GSS Jodhpur as interim arrangement and commissioning of ICT at Bhinmal Sub-station of POWERGRID by shifting the ICT available at POWERGRID Bhiwadi Sub-station (agenda by POWERGRID)**



Forum approved the SPS scheme and directed POWERGRID to implement it at the earliest. It was also agreed to trip the generation on rotational basis as per SPS operation.

**A.15 Supply and installation of OPGW on 400kV Fatehgarh I (Adani) - Fatehgarh-II (PG) line (6.5 kms), (Fatehgarh-I (Adani) – Bhadla(PG) line LILOed at Fatehgarh-II) as redundant communication for Fatehgarh-I (Adani) (agenda by CTUIL)**

- A.15.1. CTUIL apprised that presently Fatehgarh-I (Adani) is connected with Bhadla (PG) via LILO point at Fatehgarh-II (PG) with 24F OPGW on one E/W peak of Fatehgarh-I – Bhadla (PG) line. Further on the other E/W peak OPGW (24F) is also installed from Fatehgarh-II (PG) up to the LILO point of Fatehgarh-I (Adani) – Bhadla (PG) line, which is being used for earth wire functionality only as it is not continued up to Fatehgarh-I (Adani) end.
- A.15.2. As per the inputs received from Adani & POWERGRID, present connectivity is shown in the figure-1 below where 12 nos. of fibre are used for LILO of Fatehgarh-I (Adani) – Bhadla at Fatehgarh-II and 12 nos. of fibre bypassed towards Bhadla (PG) station.

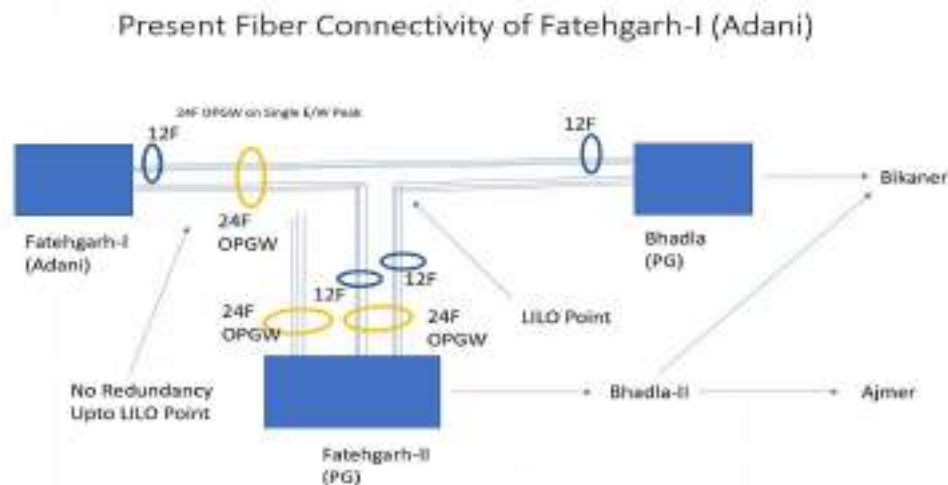

**Figure-1**

- A.15.3. It was proposed that 6.5kms 24F OPGW may be installed on the second peak of 400kV Fatehgarh I - Fatehgarh-II line by replacing the earthwire with OPGW in live line condition upto LILO point of Fatehgarh-II (PG) shown in figure-2 below:

## Proposed Fiber Connectivity of Fatehgarh-I (Adani)

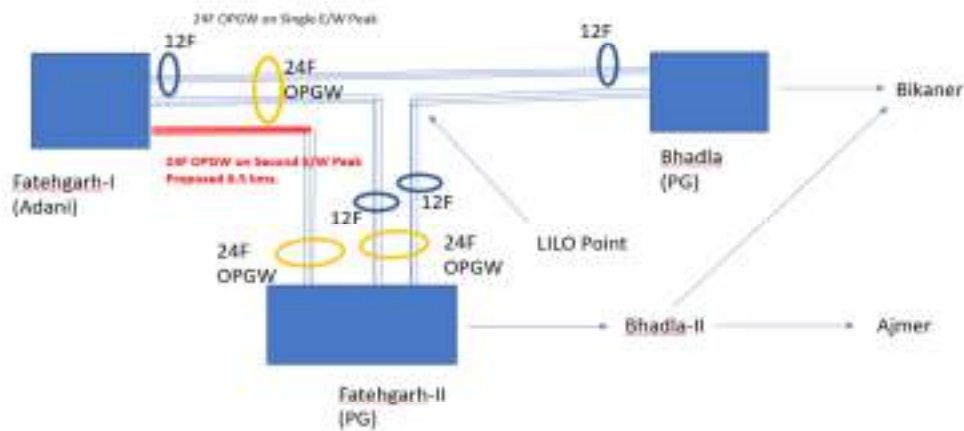

Figure-2

- A.15.4. This shall provide redundant communication for Fatehgarh-I (Adani) station up to Fatehgarh-II (PG). Additional FOTE are not required for this configuration as existing FOTE shall be used. Further as Fatehgarh-II (PG) & Bhadla (PG) are connected with other ISTS wideband nodes and thus provides two redundant paths.
- A.15.5. CTUIL representative informed that the scheme has already been deliberated in the 22<sup>nd</sup> & 23<sup>rd</sup> TeST meeting of NRPC held on 24.05.2023 & 21.09.2023 respectively.
- A.15.6. Adani Transmission Limited on RTM mode will implement the work within time frame of 18 months from the date of allocation and the estimated cost of the project is Rs. 32.5 Lakhs (approx.) (excluding taxes and duties).

**Decision of the Forum:**

*Forum approved the above proposal for supply and installation of OPGW on 400kV Fatehgarh I (Adani) - Fatehgarh-II (PG) line under RTM in line with decision taken in the 23<sup>rd</sup> TeST meeting held on 21.09.2023.*

**A.16 Supply and Installation of 12 nos. FOTE and additional ethernet (125 nos.) cards for existing FOTE in view of resource disjoint and critical locations (agenda by CTUIL)**

- A.16.1 EE (P), NRPC apprised that CEA Manual of Communication Planning states that communication resources like FOTE and Media should be resource disjoint. Inputs

for such locations where additional FOTE and ethernet cards for existing FOTE are required, have been provided by POWERGRID for NR. Details of the locations are given at **Annexure-IX**.

- A.16.2 This agenda was also discussed in the 2<sup>nd</sup> & 4<sup>th</sup> CPM of Northern Region & the 23<sup>rd</sup> TeST meeting held on 21.09.2023.
- A.16.3 CTUIL representative informed that POWERGRID on RTM mode will implement the work within time frame of 12 months from the date of allocation and the estimated cost of the project is Rs. 5.2 Crore (approx.) (excluding taxes and duties).
- A.16.4 Accordingly, CTUIL proposed for the supply and Installation of 12 nos. FOTE and additional ethernet cards as per information from POWERGRID.
- A.16.5 POWERGRID representative stated that earlier 8 cards were required but now 12 cards are required for redundancy. In view of above, to cover all locations, 125 cards are needed.

***Decision of the Forum:***

*Forum approved the supply and installation of 12 nos. FOTE and additional ethernet (125 nos.) cards for existing FOTE.*

**A.17 Supply and Installation of 11 nos. FOTE Equipment at Backup SLDCs in NR & Backup NRLDC (agenda by CTUIL)**

- A.17.1 CTUIL apprised that Grid-India vide letter dated 18.07.2023 requested for planning communication system for upcoming Backup NRLDC at Guwahati and ICCP communication from Main & Backup SLDCs to Backup NRLDC.
- A.17.2 CTUIL representative highlighted that as per the new architecture proposed by Grid-India, backup NRLDC is proposed at NER – Guwahati and backup SLDCs in the region. Further, Main and backup SLDC shall report to main and backup RLDC respectively. This agenda was discussed in the 4<sup>th</sup> CPM of Northern Region and the 23<sup>rd</sup> TeST meeting. Based on the discussion in 4<sup>th</sup> CPM of NR and inputs received from POWERGRID & STUs, locations are finalized where additional FOTE are required. Locations along with FOTE requirement are given at **Annexure-X**.
- A.17.3 POWERGRID on RTM mode will implement the work in time frame of 12 months from the date of allocation and the estimated cost of the project is Rs. 3.3 Crore (approx.) (excluding taxes and duties).

- A.17.4 CTUIL representative conveyed that the agenda has already been deliberated and agreed by all members in the 23<sup>rd</sup> TeST meeting held on 21.09.2023.
- A.17.5 POWERGRID representative raised the concern regarding time frame of the project as back up control centers are not ready for some locations.
- A.17.6 CTUIL representative informed that tendering of SCADA is anticipated to be done by October end and after ten months hardware delivery is supposed to be started. Accordingly, SLDC may get the control centers ready within this period. He opined to go with this time frame.

**Decision of the Forum:**

*Forum approved the proposal of CTU for Supply and Installation of 11 nos. FOTE Equipment at Backup SLDCs in NR & Backup NRLDC.*

**A.18 Hosting of physical TCC & NRPC meeting (agenda by NRPC Secretariat)**

- A.18.1 EE (P), NRPC conveyed that a roster for hosting of meetings, was agreed in the 40<sup>th</sup>TCC/43<sup>rd</sup>NRPC meetings held on 29<sup>th</sup>/30<sup>th</sup>October, 2018. The roster is as below:

1.Member IPP	9. Punjab	17. Member Trades/PTC
2.NPCIL	10.Member IPP	18. Delhi
3.J&K	11. Rajasthan	19.Member IPP
4.THDC	12. POWERGRID	20. BMB
5.Member IPP	13. UT of Chandigarh	21. Uttarakhand
6. Haryana	14.Member IPP	22. HP
7. SJVN	15. NHPC	
8. NTPC	16. UP	

Roster for Members IPP is as followed:

1. Adani Power	6.LPGCL
2.APCPL	7.NPL
3.CLP	8.PPGCL
4.JSW Power	9.RPSC
5.LAPL	10.TSPCL

- A.18.2 MS, NRPC commented that physical meeting of NRPC will be conducted quarterly as per previous decision. He further proposed that along with NRPC meeting, Technical Coordination Committee meeting (TCC) may also be held quarterly one day before of scheduled NRPC meeting.
- A.18.3 He also conveyed that utilities need some time to prepare for hosting the meeting. Accordingly, based on previous meetings conducted by utilities, it is proposed to make a meeting plan upto FY 2024-25 that needs to include all utilities viz. PSUs,



भारत सरकार

Government of India

विद्युत मंत्रालय

Ministry of Power

उत्तर क्षेत्रीय विद्युत समिति

Northern Regional Power Committee

सं. उ.क्षे.वि.स./वाणिज्यिक/ 209/ आर पी सी (70)/ 2023

दिनांक: 08 दिसम्बर, 2023

सेवा में/To,

एनआरपीसी एवं टीसीसी के सभी सदस्य एवं विशेष आमंत्रित (संलग्न सूचीनुसार)

Members of NRPC & TCC & Special Invitees (As per List)

**विषय: उत्तर क्षेत्रीय विद्युत समिति की 70 वीं और तकनीकी समन्वय समिति (टीसीसी) की 48 वीं बैठक का कार्यवृत्त।**

**Subject: 70th Northern Regional Power Committee (NRPC) & 48<sup>th</sup> Technical Co-ordination Committee (TCC)-MoM**

महोदय/महोदया,

तकनीकी समन्वयन समिति (टीसीसी) की 48 वीं बैठक दिनांक 17.11.2023 (सुबह 10:30 बजे) एवं उत्तर क्षेत्रीय विद्युत समिति की 70 वीं बैठक दिनांक 18.11.2023 (सुबह 10:30 बजे) को अमृतसर, पंजाब में आयोजित की गयी थी। बैठक का कार्यवृत्त संलग्न है। यह उ.क्षे.वि.स. की वेबसाइट (<http://164.100.60.165/>) पर भी उपलब्ध है।

48th meeting of Technical Co-ordination Committee (TCC) was held on 17.11.2023 (10:30 AM) and 70th meeting of Northern Regional Power Committee (NRPC) was held on 18.11.2023 (10:30 AM) at Amritsar, Punjab. MoM of the same is attached herewith. The same is also available on NRPC Sectt. Website (<http://164.100.60.165/>).

भवदीय

Yours faithfully

(वी.के. सिंह)

(V.K. Singh)

सदस्य सचिव

Member Secretary

प्रतिलिपि: मोहम्मद शायिन, एमडी, एचवीपीएनएल एवं अध्यक्ष, एनआरपीसी ([md@hvpn.org.in](mailto:md@hvpn.org.in))

I/32257/2023

48<sup>th</sup> TCC & 70<sup>th</sup> NRPC Meeting (17-18 Nov 2023)-MoM

participants for putting their ideas and knowledge to the forum and reach to a conclusion.

Thereafter, agenda for the 70<sup>th</sup> NRPC Meeting was presented & deliberated. The list of participants is attached as **Annexure-Q**.

**Consolidated MoM of 48<sup>th</sup> TCC and 70<sup>th</sup> NRPC Meetings**

**A.1 Approval of MoM of 47<sup>th</sup> TCC meeting and 69<sup>th</sup> NRPC meeting**

A.1.1 EE (P), NRPC apprised that the minutes of the 47<sup>th</sup> TCC meeting (held on 23.09.2021) were issued vide letter dtd. 25.11.2021. No comment from any utilities has been received, therefore, the same may be considered to be approved.

**TCC Deliberation:**

A.1.2 Forum recommended for approval of the minutes of 47<sup>th</sup> TCC as issued.

**NRPC Deliberation:**

A.1.3 It was apprised that the minutes of the 69<sup>th</sup> NRPC meeting (held on 27.09.2023) were issued vide letter dtd. 03.11.2023. Comments received from CTU vide mail dtd. 07.11.2023 were deliberated.

**Decision of NRPC forum:**

- i. Forum approved the minutes of 47<sup>th</sup> TCC as issued.
- ii. Minutes of 69<sup>th</sup> NRPC meeting were approved with inclusion of CTUIL comments as below:

<b><i>Text as per MoM Issued</i></b>	<b><i>Amended Text</i></b>
<i>Decision of the forum: Forum accorded approval to proposal of CTUIL for OPGW installation on LILOed portion of existing 400kV Kota- Merta line at Shri Cement under RTM.</i>	<i>Decision of the forum: Forum accorded approval to the proposal of CTUIL for OPGW installation on existing 400kV Kota- Merta line (254 kms.) along with LILO portion of Shri Cement (54 kms.) (254+54=308Km) under RTM mode to POWERGRID.</i>
<i>Decision of the forum: Forum approved the above proposal for supply and installation of OPGW on 400kV Fatehgarh I (Adani) - Fatehgarh-II (PG)</i>	<i>Decision of the forum: Forum approved the above proposal for supply and installation of OPGW on 400kV Fatehgarh 1 (Adani)- Fatehgarh 2 (PG)</i>

I/32257/2023

48<sup>th</sup> TCC & 70<sup>th</sup> NRPC Meeting (17-18 Nov 2023)-MoM

<i>line under RTM in line with decision taken in the 23rd TeST meeting held on 21.09.2023.</i>	<i>line (6.5 Km on second earthwire peak) under RTM mode to ADANI Transmission Ltd. in line with decisions taken in 23rd TeST meeting held on 21.09.2023.</i>
<i>Decision of the forum: Forum approved the supply and installation of 12 nos. FOTE and additional ethernet (125 nos.) cards for existing FOTE.</i>	<i>Decision of the forum: Forum approved the supply and installation of 12 nos of FOTE and additional ethernet cards (125 nos.) for existing FOTE under RTM mode by POWERGRID.</i>
<i>Decision of the forum: Forum approved the proposal of CTU for Supply and Installation of 11 nos. FOTE Equipment at Backup SLDCs in NR &amp; Backup NRLDC.</i>	<i>Decision of the forum: Forum approved the proposal of CTU for supply and installation of 11 nos. of FOTE equipment at backup SLDCs in NR and backup NRLDC under RTM mode by POWERGRID.</i>

## **A.2 Sensitization on CEA Regulations (agenda by CEA)**

### **TCC Deliberation**

A.2.1 CE (RA division), CEA apprised that under section 177 and other various sections of the Electricity Act, 2003 (36 of 2003), the Central Electricity Authority has notified the following regulations:

1. Central Electricity Authority (Installation & Operation of Meters), Regulations 2006
2. Central Electricity Authority (Technical Standards for Connectivity to the Grid) Regulation, 2007
3. Central Electricity Authority (Furnishing of Statistics, Returns & Information) Regulation, 2007
4. Central Electricity Authority (Grid Standards) Regulation, 2010
5. Central Electricity Authority (Safety Requirements for Construction, Operation and Maintenance of Electrical Plants and Electric Lines) Regulations, 2011
6. Central Electricity Authority (Technical Standards for Connectivity of the Distributed Generation Resources) Regulations, 2013.
7. Central Electricity Authority (Technical Standards for Communication System in Power System Operations) Regulations, 2020

**सेंद्रल ट्रान्समिशन यूटिलिटी ऑफ इंडिया लिमिटेड**

(पावर ग्रिड कॉर्पोरेशन ऑफ इंडिया लिमिटेड के स्वामित्व में)

(भारत सरकार का उद्यम)

**CENTRAL TRANSMISSION UTILITY OF INDIA LTD.**

(A wholly owned subsidiary of Power Grid Corporation of India Limited)

(A Government of India Enterprise)

Ref: CTU/N/ REZ Ph-IV (Part-3&amp;4)

Date: 19<sup>th</sup> January, 2024

As per distribution list

**Sub: Minutes of meeting for Joint study meetings held on 28.12.23 & 09.01.24 to deliberate & finalize the Transmission system for evacuation of power from Bikaner & Fatehgarh/Barmer Complex as part of Rajasthan REZ Ph-IV (Part-3a :2.4GW) and REZ Ph-IV (Part-4 :3.5GW) respectively**

Dear Sir,

Please find enclosed the Minutes of meeting for Joint study meetings held on 28.12.23 & 09.01.24 to deliberate & finalize the Transmission system for evacuation of power from Bikaner & Fatehgarh/Barmer Complex as part of Rajasthan REZ Ph-IV (Part-3a :2.4GW) and REZ Ph-IV (Part-4 :3.5GW) respectively through virtual mode.

Thanking you,

Yours Faithfully,

(Sandeep Kumawat)  
DGM (CTU)

Encl : Minutes of Meeting



**Distribution List:**

<b>Chief Engineer (PSP&amp;A – I)</b> Central Electricity Authority Sewa Bhawan, R.K.Puram, New Delhi-110 066	<b>Member Secretary</b> Northern Regional Power Committee 18A, Shaheed Jeet Singh Sansanwal Marg, Katwaria Sarai, New Delhi – 110 016
<b>Director (Power System)</b> Solar Energy Corporation of India Ltd. D-3, 1 <sup>st</sup> Floor, A wing, Religare Building, District Centre, Saket, New Delhi-110017	<b>Director</b> Ministry of New and Renewable Energy, Block 14, CGO Complex, Lodhi Road, New Delhi-110003
<b>Director (SO)</b> Grid Controller of India Limited (erstwhile Power System Operation Corporation Ltd.) 9 <sup>th</sup> Floor, IFCI Towers, 61, Nehru Place, New Delhi-110 016	<b>Executive Director</b> Northern Regional Load Despatch Centre 18-A, Qutab Institutional Area, Shaheed Jeet Singh Sansanwal Marg, Katwaria Sarai, New Delhi– 110 016
<b>Director (P&amp;C),</b> HPPTCL, Headoffice, Himfed Bhawan,Panjari, Shimla-171005, Himachal Pradesh	<b>Director(W&amp;P)</b> UP Power Transmission Company Ltd. Shakti Bhawan Extn, 3rd floor, 14, Ashok Marg, Lucknow-226 001
<b>Director (Technical)</b> Punjab State Transmission Corporation Ltd. Head Office, The Mall, Patiala 147001, Punjab	<b>Director (Projects)</b> Power Transmission Corporation of Uttarakhand Ltd. Vidyut Bhawan, Near ISBT Crossing, Saharanpur Road, Majra, Dehradun.
<b>Development Commissioner (Power)</b> Power Development Department Grid Substation Complex, Janipur, Jammu	<b>Director (Technical)</b> Rajasthan Rajya Vidyut Prasaran Nigam Ltd. Vidyut Bhawan, Jaipur, Rajasthan-302005.
<b>Member (Power)</b> Bhakra Beas Management Board Sector-19 B, Madhya Marg, Chandigarh - 160019	<b>Superintending Engineer (Operation)</b> Electricity Circle, 5 <sup>th</sup> Floor, UT Secretariat, Sector-9 D, Chandigarh - 161009
<b>Director (Operations)</b> Delhi Transco Ltd. Shakti Sadan, Kotla Road, New Delhi-110 002	<b>Director (Technical)</b> Haryana Vidyut Prasaran Nigam Ltd. Shakti Bhawan, Sector-6, Panchkula-134109, Haryana

**Minutes of meeting for Joint study meetings held on 28.12.23 & 09.01.24 to deliberate & finalize the Transmission system for evacuation of power from Bikaner & Fatehgarh/Barmer Complex as part of Rajasthan REZ Ph-IV (Part-3a :2.4GW) and REZ Ph-IV (Part-4 :3.5GW) respectively.**

Joint study meetings were held on 28.12.23 & 09.01.24 to deliberate & finalize the Transmission system for evacuation of power from Bikaner & Fatehgarh/Barmer Complex as part of Rajasthan REZ Ph-IV (Part-3a :2.4GW) and REZ Ph-IV (Part-4 :3.5GW) respectively.

Details of Deliberations are as under

**Gist of discussion in Joint study meeting held on 28.12.23**

It was stated that Renewable Energy Zones (REZs) were identified by MNRE/SECI with a total capacity of 181.5 GW for likely benefits by the year 2030 in eight states, which includes 75 GW REZ potential in Rajasthan comprising of 15 GW Wind and 60 GW Solar. In this regard a Committee on Transmission Planning for RE was constituted by MOP for planning of the requisite Inter State Transmission System required for the targeted RE capacity by 2030 for which a Comprehensive transmission plan for evacuation of 75GW RE potential from Rajasthan was evolved. Details of schemes approved/Under Planning scheme as part of above is as under:

S.No	Transmission Scheme	RE Potential	Status
<b>A Under Bidding/ Approved</b>			
1	Rajasthan REZ Ph-IV (Part-1 :7.7GW) (Bikaner Complex)	14 GW (Solar 14GW, BESS:6GW) Bikaner-II : 3.7GW Bikaner-III: 4GW	Awarded
2	Rajasthan REZ Ph-IV (Part-2 :5.5GW) (Jaisalmer/Barmer Complex)	5.5GW (Solar) Fatehgarh-IV: 4 GW Barmer-I: 1.5 GW	Under Bidding
3	Rajasthan REZ Ph-IV (Part-3 :3.6GW) (Bikaner Complex)	3.6 GW (Solar) Bikaner-IV:3.6GW	Under approval with NCT
<b>B Planned/Under Planning</b>			
1	Rajasthan REZ Ph-IV (Part-3a :2.4GW) (Bikaner Complex)	2.4 GW (Solar) Bikaner-IV : 2.4GW	Scheme planned for 2026-27 time frame (EHVAC)- Present proposal
2	Rajasthan REZ Ph-IV (Part-4 :3.5GW) (Jaisalmer/Barmer Complex)	3.5 GW (Solar) Fatehgarh-IV: 1 GW Barmer-I: 2.5 GW	
3	Rajasthan REZ Ph-IV (Part-5 : 6GW) (Barmer Complex)	6 GW (Solar) Barmer-II : 6GW	Scheme planned for 2029 time frame (HVDC)
4	Rajasthan REZ Ph-IV (Part-6 : 6GW) (Bhadla/Bikaner Complex)	6 GW (Solar) Bhadla-IV: 2 GW Bikaner-V: 4 GW*	

\*SECI to confirm total RE potential at Bikaner-V

## **A. Rajasthan REZ Ph-IV (Part-3a :2.4GW) (Bikaner Complex)**

It was stated that transmission scheme is evolved for about 7.7GW (Solar) in Bikaner complex (14 GW potential along with 6 GW BESS) in Rajasthan for RE potential identified at Bikaner complex as part of committee report. However, no application of BESS (linked with RE) against envisaged 6GW was received. Accordingly, RE potential of about 7.7GW (in place of 14GW) can be evacuated from planned system (Ph-IV scheme) from Bikaner complex (Bikaner-II(3.7 GW) & Bikaner-III(4 GW)).

Further with development of RE transmission scheme planned as part of Ph-IV transmission schemes in Bikaner and Fatehgarh/Barmer complex, as well as other strengthening schemes, additional margin is created at Bikaner-III PS, which will be evacuated with Bikaner-IV tr. System and allocated as per priority of applications at Bikaner-IV.

Subsequently, Transmission scheme was evolved and approved in 25<sup>th</sup> CMETS-NR meeting for about 3.6 GW (Solar) as part of Rajasthan REZ Ph-IV (Part-3 :3.6GW) (Bikaner Complex) for injection at Bikaner-IV in Rajasthan. At present connectivity of about 5.4 GW is already agreed/received against its total potential (6GW) and more applications are expected due to land availability and being outside of GIB area. Therefore, HVDC from Bikaner complex is planned.

As part of EHVAC system, evacuation system is planned for 2.4GW capacity (thus makes total capacity of 6 GW at Bikaner-IV PS) comprising Bikaner-IV PS – Churu 765 kV D/c line (2nd line and LILO of 2nd ckt of 765 kV Sikar-II (PG) -Khetri (PG) D/c line at Churu S/s. For onward dispersal of power, Siwani – Sonipat (PG) 400 kV D/c line (Quad) is also planned.

For EHVAC system, studies were carried out in 2026-27 time frame in solar maximized scenario and Study files for solar maximized scenario was shared on 20.12.23 with all constituents. Considering grant of connectivity to new RE generators in Bikaner complex as well as for evacuation of power beyond Bikaner complex, following transmission scheme is proposed for evacuation of power from Rajasthan REZ Ph-IV (Part-3a :2.4GW) [Bikaner complex]. Details of proposed EHVAC scheme is as under

## **A. Transmission system for evacuation of power from Bikaner Complex as part of Rajasthan REZ Ph-IV (Part-3a :2.4GW)**

In the above meeting following transmission system was proposed for evacuation of power from Rajasthan REZ Ph-IV (Part-3a :2.4GW) for evacuation of power from Bikaner complex

### **Bikaner-IV: 2.4GW (Solar)**

- Augmentation of 1x1500 MVA(5<sup>th</sup>), 765/400 kV ICT at Bikaner-IV Pooling Station
- Augmentation of 3x500 MVA (5<sup>th</sup> to 7<sup>th</sup>), 400/220 kV ICT at Bikaner-IV Pooling Station#
- 220kV line bays (3 nos.) for RE connectivity at Bikaner-IV PS#
- Bikaner-IV PS – Churu 765 kV D/c line (2<sup>nd</sup>) along with 240 MVA<sub>r</sub> switchable line reactor for each circuit at Bikaner-IV PS end (~175 km)
- LILO of other ckt of 765 kV Sikar-II (PG) -Khetri (PG) D/c line at Churu S/s\* (~80 km)
- Augmentation of 765/400 kV, 1x1500 MVA ICT (4<sup>th</sup>) at Siwani S/s
- Siwani – Sonipat (PG) 400 kV D/c line (Quad Moose) (~150 km) along with 63 MVA<sub>r</sub> switchable line reactor for each circuit at Siwani S/s end

**\*one ckt is already LILLOed as part of Rajasthan REZ Ph-IV (Part-3 :3.6GW) scheme)**

**# To be finalized as per application received**

In the meeting, CEA stated that with Phase-IV Part 3a (2.4GW) proposed scheme, there will be no requirement of 765/400kV Churu S/s & associated interconnections, which were earlier agreed in 25<sup>th</sup> CMETS-NR meeting as part of Phase-IV Part 3 (3.6GW) scheme.

CEA stated that in the earlier agreed Phase-IV Part 3 (3.6 GW) scheme, Churu S/s & associated transmission scheme (LILO of one ckt of 765 kV Sikar-II (PG) -Khetri (PG) D/c line at Churu S/s and Churu- Fatehabad (PG) 400 kV D/c line) was considered to address issue on synchronization of line after corridor outage (765kV Bikaner-IV-Siwani D/c line) in N-1-1/N-2 in peak solar hours as emphasized by Grid-India. CEA stated that in place of Bikaner-IV – Churu D/c line, a parallel corridor towards Siwani S/s i.e. 765kV Bikaner-IV- Siwani D/c line may be considered for additional 2.4GW evacuation of power as part of scheme. With the above parallel 765kV corridor i.e. 765kV Bikaner-IV – Siwani D/c line, angular stability issue under N-1-1 contingency will be resolved as 4 nos. of 765kV circuits are available towards Siwani S/s. Further in future, if there is requirement of establishment of Churu S/s, Bikaner-IV – Siwani D/c line may be LILOed at Churu S/s.

Further, it was deliberated that Transmission system for evacuation of power from Bikaner Complex as part of Rajasthan REZ Ph-IV (Part-3 :3.6GW) is being taken up for approval in next NCT. In view of that both the schemes viz Ph-IV: Part 3 (3.6GW) & Ph-IV: Part 3a (2.4GW)) may be considered comprehensively for 6GW evacuation.

CTU stated that they will review the proposal based on CEA observations and deliberations in meeting and evaluate various alternatives (with and wo Churu S/s) in a comprehensive manner. Accordingly, the scheme will be further deliberated and finalized in next Joint study meeting.

#### **Gist of discussion in Joint study meeting held on 09.01.24**

As per deliberation held in Joint study meeting held on 28.12.23, CTU examined both the proposals as below with two alternatives

- **Alternative-1** : Bikaner-IV- Churu- Siwani 765kV D/c & Bikaner-IV- Siwani 765kV D/c & associated transmission interconnection at Churu S/s i.e. LILO of one ckt of 765 kV Sikar-II (PG) -Khetri (PG) D/c line at Churu S/s and Churu- Fatehabad (PG) 400 kV D/c line & onwards 400kV transmission system from Siwani S/s (Towards Jind, Patran, Sonipat)
- **Alternative-2**: Bikaner-IV- Siwani 765kV 2xD/c line & onwards 400kV transmission system from Siwani S/s (Towards Jind, Patran, Fatehabad, Sonipat)

Details of both the alternatives are enclosed in **Annexure-1**.

It was stated that recently additional margin of about 600MW (over 4GW planned capacity) was released at Bikaner-III PS, with Bikaner-IV transmission system. In the earlier agreed system (LILO of one ckt of 765 kV Bikaner-III -Neemrana-II D/c line at Bikaner-IV PS), 765/400kV ICTs at Bikaner-III PS and Bikaner (PG) is higher in N-1 contingency. Space is not available for augmentation of new at 765/400kV ICT (5<sup>th</sup>) at Bikaner (PG) and 765/400kV ICT (7<sup>th</sup>) at Bikaner-III PS. Therefore, in place of LILO of one ckt of 765 kV Bikaner-III -Neemrana-II D/c line at Bikaner-IV PS, LILO of both ckts of 400kV Bikaner II- Bikaner-III D/c line (Quad) at Bikaner-IV is proposed which will relieve the above ICT loadings and increase the operational margin on above ICTs. Additionally STATCOM at Siwani ( $\pm 300$ MVar) is proposed in Alternate-2 to mitigate low voltage issue.

Further, Observations were received on 04.01.24 from Grid-India and CEA on both the alternatives for transmission system for evacuation of power from Bikaner complex as part of Rajasthan REZ Ph-IV (Part-3). Major observations are as under

**A. Grid-India Observations/Comments**

- With a dispatch of 1470 MW of the IC of 1840 MW for RAPP-C, N-1 violations of 400 kV RAPP-C – Shujalpur D/c is being observed for both the cases. However, with the establishment of 765 kV Churu S/S (Alternative - 1), relief of 10-11 MW is seen in each circuit.
- STATCOMs at Bikaner – IV & other stations kept in switched off conditions. All STATCOMs may be modelled and made in service as per approved plan.
- During peak solar period, voltages at Siwani (730kV) and Bikaner-IV (740kV) are very low even after taking B/Rs out. If line reactors are to be taken out of service for maintaining voltages, the same needs to be mentioned along with the scheme. Further, line reactor ratings for 765kV BikanerIV- Siwani ckts may be corrected in June base case (330MVAR reactor shown)
- Considering the identified solar potential at Churu by SECI, establishment of Churu substation will help in tapping the solar generation in that complex. CTUIL may clarify its plan and the timelines for establishing the ISTS Churu substation, if the same is not being taken up right now.

Additionally, Grid-India in 25<sup>th</sup> CMETS-NR meeting opined that in case of direct interconnection of Bikaner-IV to Siwani i.e. not considering 765/400kV Churu in between and onward transmission system, the Transmission system is kind of radial system connected with RE generation pocket and poses stability issues in various operational scenarios in future. Further Grid-India also requested to share Study cases for off peak scenarios. Other study related comments received from Grid-India was also deliberated in above Joint study meeting

**B. CEA Observations/Comments**

- Power flow in both the alternatives seems to be in order.
- Transmission system requirement is less in Alt 2. This would result in saving of hundreds of crore.
- In Alt 2, with Bikaner-IV- Siwani 765 kV 2xD/c line, issue of synchronization of line after corridor outage (765 kV Bikaner-IV-Siwani D/c line) in N-1-1/N-2 in peak solar hours as highlighted by Grid-India gets resolved.
- As intimated by CTUIL, connectivity applications of 5.4 GW RE has already been received against potential of 6 GW. Therefore, a comprehensive scheme for 6 GW RE evacuation could be implemented.
- In view of the above, Alt 2 seems to be preferable at present. Churu substation could be implemented in future, if required, with LILO of Bikaner-IV- Siwani 765 kV line to cater to the potential in Churu district.
- Inputs regarding firm schedule of requirement of Churu S/s (for RE potential) may be taken from SECI.
- In case Grid-India anticipates or highlights major operational issues other than N-1-1/N-2 in Alt 2, both the alternatives may be reviewed accordingly.

CTU analyzed both the alternatives with above changes and observations are as under :

S.No.	Alternative-1 : Bikaner-IV- Churu- Siwani 765kV D/c & Bikaner-IV- Siwani 765kV D/c & associated transmission interconnection at Churu S/s	Alternative-2: Bikaner-IV- Siwani 765kV 2xD/c line)
1	Rajasthan REZ Ph-IV (Part-3 :3.6GW) is under approval in NCT and change in earlier agreed scheme (3.6GW) will delay the implementation timeline for 3-4 months and may impact the evacuation of RE generation from Bikaner-IV PS. <b>Tentative timeline for scheme (3.6GW) : Jul'26</b> <b>Tentative timeline for scheme (2.4GW) : Sep'26</b>	Comprehensive scheme for 6GW will be implemented with <b>tentative timeline of Sep'26</b>
2	SECI vide mail 07.12.23 informed that Southwest Churu has solar potential & therefore considering solar potential at Churu as indicated by SECI, 220kV future scope was retained at Churu S/s as earlier agreed in 25th CMETS-NR meeting.	Churu Substation may be planned with future transmission proposals i.e. Bikaner-V, other strengthening schemes based on requirement. Therefore, RE evacuation from Churu S/s will only be possible at later stage (beyond 2027) in Alt-2.
3	Due to shorter line length (Bikaner-IV-Churu & Churu-Siwani section), under N-1 contingency of 765kV Bikaner-IV-Churu-Siwani corridor, voltage dipping at Bikaner-IV and Siwani in Alt-1 will be lesser (about 10kV than Alt-2) and in the range of 740 -750kV considering STATCOM at Bikaner-IV under various operating scenario.	Due to longer line length, under N-1 contingency of 765kV Bikaner-IV-Siwani , voltage dipping in Alt-2 will be higher (about 10kV than Alt-1) and in the range of 730-740kV considering STATCOM at Bikaner-IV under various operating scenario. In above scenario STATCOM ( $\pm 300$ MVar) at Siwani may also be required (in case of operational difficulty of line reactors switching on EHVAC lines in RE pockets). <b>Grid-India may comment.</b>
4		<b>Estimated Cost of scheme is about 12% lower (about Rs 1200 Cr) is lower than Alt-1*</b>

\* incl. cost of Siwani STATCOM ( $\pm 300$ MVar)

Revised study files with proposed changes (LILO of both ckts of 400kV Bikaner II- Bikaner-III D/c line at Bikaner-IV PS in place of LILO of one ckt of 765 kV Bikaner-III -Neemrana-II D/c line at Bikaner-IV PS & Siwani STATCOM (in Alt-2)) was circulated on 06.05.24 along with study plots.

CTU enquired SECI that with Alt-2, Churu substation is not being considered for evacuation of RE potential indicated by SECI in earlier meetings. SECI stated that Churu complex was not identified in solar potential zone as part of 500GW report and thereafter potential was indicated only because the substation was planned as part of agreed Bikaner-IV transmission scheme (3.6GW), however no response from RE developers is yet received to assess & harness RE potential at Churu complex. CTU stated that in above case till no confirmation received from SECI, RE potential at Churu will not be considered and may be evolved based on SECI inputs at later stage.

Grid-India stated that in June solar scenario studies, pf of Punjab/Haryana load is considered near to 0.99 pf which is very optimistic. However, in real time they have faced voltage dipping issues in Punjab and Haryana intra state network and interstate network (incident to intra state) due to high reactive power drawl in paddy season. This Intra state reactive support may

further reduce in paddy season due to envisaged hydro generation from J&K/HP and solar generation from Rajasthan.

CTU enquired to Grid-India about capacitive support by STUs/DISCOMs in real time to improve load pf and mitigate voltage dipping issues in peak loading season. Grid-India stated that in real time capacitor bank support is available in Punjab, however in Haryana low voltage issue is still persist in June-July peak loading season.

CTU stated that in the integrated planning of transmission system, reactive power (MVAR) drawl/absorption requirement at load end to be compensated at intra state network level only and ISTS system is not supposed to be planned to compensate MVAR injection/ drawl from intra state network under various operating scenario as it will also increase losses due to MVAR flow to downstream network from upstream network which is not desirable. In view of that load pf ( $>0.98\text{pf}$ ) may be maintained by STUs/DISCOMs specially in Punjab & Haryana through new capacitive banks, if required and also provide progress of installing new capacitors in monthly OCC/NRPC meetings.

Considering above, it was decided that STUs specially Haryana may assess the reactive compensation requirement for peak load season in next 2-3 years and may take necessary actions to maintain pf and mitigating low voltage issues in intra state network. HVPN told that they have planned capacitor banks installation at downstream network.

Grid-India stated that in present proposal (in both alternatives), with LILO of both ckts of 400kV Bikaner II- Bikaner-III D/c line (Quad) at Bikaner-IV in place of LILO of one ckt of 765 kV Bikaner-III -Neemrana-II D/c line (2nd) at Bikaner-IV PS, more than 7GW power evacuated through Bikaner-IV system. Grid-India highlighted the voltage dipping issue at Siwani substation ( $\sim 730\text{kV}$ ) in N-1 contingency. The voltage will further decreases to 725kV, with no STATCOM reactive support (STATCOM support reserved for dynamic support only)

CEA stated that line reactors on EHVAC lines can be switched off during low voltage as it will give direct relief to improve voltage to 15-20kV, however operational difficulties in switching on/off of line reactors may be deliberated. Further STATCOM at Siwani S/s may be considered  $\pm 600\text{MVAR}$  (earlier  $\pm 300\text{MVAR}$  proposed in scheme) along with MSC/MSR to provide voltage support.

Grid-India stated that as per the earlier experience, line reactor switching (switched off) is avoided in RE pockets connected through radial system (Fatehgarh/bhadla complex) due to tripping of RE plants in HVRT.

CEA stated the proposed Bikaner-IV system is not radial and proposed to be well connected to Bikaner-II/Bikaner-III system through 400kV D/c lines. CTU stated this at present, only Ph-I and part Ph-II system is commissioned, however in next 2-3 years transmission scheme of about 40-45GW will be commissioned through various interlinking lines (within various RE complexes) as well as inter regional links (NR-WR). With the increase in SCMVA and high SCR of various RE substations, impact of line reactor switching on HVRT tripping may be not as that severe.

Grid-India stated that earlier, voltage in Fatehgarh complex was observed up to 720kV in peak solar hours and under such condition, sequential line reactor switching was carried out in for volage control, however they have faced resistance from TSPs regarding line reactor switching and line opening for voltage control. In view of that provision of switching of line reactors may be clearly stipulated in the RfP of proposed scheme.

CEA stated that line reactor switching in RE pockets is in general operational requirement and need not to be specific for one scheme and should be carried out in real time as per Grid requirement.

CTU stated that presently as per IEC standard followed for breaker duty cycle, class M2 circuit breakers i.e frequently operated CBs for special service requirements and designed so as to require only limited maintenance, mechanical type tested for 10,000 operations.

CEA stated that there is any difference in bus reactors switching and line reactor switching. CTU stated that as per information available, the position of breakers w.r.t reactors is the only difference in bus or line reactors, however its impact to be confirmed by the TSP. however whenever such line reactor switching issue raised by TSP in future, it should come with proper reasoning & justification from TSP side.

Grid-India stated that in new STATCOMs, MSC/MSR may only be used for dynamic range due to controller design features in which MSC/MSR support is only available once certain dynamic reserve is already used. It was also stated that MSC has its own switching time and with fault recovery, MSC may not come in picture Therefore, in steady state study file, STATCOMs along with MSC/MSR may be kept off for worst scenario. To mitigate low voltage issues without STATCOM support, line reactors to be switched off as per requirement.

CTU stated that in base case voltage at Siwani S/s is about 733kV and in N-1 contingency of one ckt of Bikaner-IV-Siwani 2xD/c lines, voltage may further reduce to 728kV. In above scenario, voltage will be improved to 740kV considering STATCOM (at Bikaner-IV and Siwani) and 748kV with STATCOM+MSC at Bikaner-IV & Siwani S/s. However, in case STATCOM along with MSCs is kept off as suggested by Grid-India and line reactor switching is carried out, it will further improve the voltage of Siwani S/s by 750kV (line reactors on other 3 ckts of 765kV Bikaner-IV-Siwani kept off). In view of that it is recommended that steady state voltage to be maintained over 750kV in planning files considering line reactor switching (760kV at Siwani S/s in present case with line reactor on 765kV Bikaner-IV -Siwani kept off) . Accordingly, it was decided by CEA, CTU & Grid-India that line reactor switching may be carried out in a sequential manner in RE pockets for better voltage control.

Grid-India enquired that studies may be rechecked in nine scenarios for any additional requirement. CTU stated in RE related planning studies, studies were carried out in maximum stressed scenarios considering NR peak/off peak scenarios, NR import/export, reactive compensation etc. studies for All India nine scenarios will be shared in March month as part of Rolling plan report and based on which any additional requirement, if any may be discussed separately.

CTU stated that in Feb solar maximized scenario, loading of 400kV RAPP- Shujalpur D/c line is critical (about 940MW) in N-1 contingency. To relieve loading of above line, EHVAC corridor from RAPP generating station or other transmission corridor in parallel to above line to be planned. In 500GW report also, 765kV Ajmer-Kota-Shujalpur transmission corridor was planned to integrate RE complexes of Ajmer. In view of that, it was decided that loading of above line will be reviewed with progress of RE generation projects at Rajasthan and planning to be carried out in next phase to relieve loading on above line. Grid-India & CEA agreed for the same

Grid-India enquired that timeline for implementation of two nos. of Bikaner-IV-Siwani D/c lines will be same or different. CEA stated that scheme will be segregated in various packages and efforts to be made that all the packages are implemented simultaneously with implementation timeline decided in NCT meeting.

Grid-India stated that as per past experiences, there will be always some mismatch (up to 6 months) in implementation time of two parallel double ckt corridors from same RE pooling stations. In such situation, in the event of only one corridor i.e. 765kV Bikaner-IV-Siwani D/c



is commissioned and 2<sup>nd</sup> 765kV D/c gets delayed, RE generation of 2-3GW may only be evacuated in base case with one D/c and in N-1 contingency, however in N-1-1 contingency, restoration of line becomes delayed in solar peak hours and shall impact the RE generation.

CEA enquired about connectivity timelines of RE generators applying for connectivity at Bikaner-IV. CTU stated that timelines for RE generators is progressively from Jun'25.

CTU stated that considering HVPNL existing & proposed interconnections, interconnections as well as GNA granted to bulk consumer for 100MW GNA at 220kV Jind(PG), 400/220kV ICTs (3x500 MVA) at Jind(PG) are critically loaded in N-1 contingency. However, decision on implementation timeframe of ICT augmentation at Jind (PG) may be taken based on timeline of HVPNL proposed interconnections and future load growth (on 220kV Nain, Jind and IOCL S/s of HVPNL).

Grid-India stated that at present 400/220kV Jind(PG) S/s has 2x500MVA ICTs & 4 nos. of 220kV interconnections whereas 3<sup>rd</sup> ICT (500MVA) in ISTS by POWERGRID and 4 nos. of STU feeders are under implementation by HVPNL. At present loading on 2x500MVA ICT is about 500MW (peak) and in view of that ICT augmentation at Jind may considered at later stage with commissioning of HVPNL interconnections & 400/220kV ICT (3<sup>rd</sup>) at Jind(PG). HVPNL stated that 400kV Munakh S/s for power evacuation of YTPP (800MW) is under planning. Additionally, 640MVA load will be envisaged progressively from 2027 by IOCL. In view of that It was decided that ICT loading will be monitored in real time with implementation of HVPNL feeders and load growth in Jind area. Accordingly, requirements will be assessed based on Grid-India operational feedback report and loading diversion in planning studies considering HVPNL proposal for evacuation of power from YTPP generation (800MW). CEA agreed for the same

Grid-India also stated to provide off peak file with proposed scheme. CTU stated that off peak file is under preparation and same will be provided within this week. Based on which reactive compensation requirement will be checked and any additional requirement will be included in final proposal. Subsequently, off peak file were circulated on 13.01.24 to all stakeholders. Result of system studies incorporating observations received from stakeholders is enclosed in **Exhibit-1**.

In view of above deliberations, following transmission scheme was agreed in the above Joint study meetings (28.12.23 & 09.01.24)

### **Transmission system for evacuation of power from Rajasthan REZ Ph-IV (Part-3 : 6GW)**

#### **Bikaner-IV: 6 GW (Solar)**

- Establishment of 6x1500 MVA, 765/400 kV & 6x500 MVA, 400/220 kV Bikaner-IV Pooling Station along with 2x240 MVA (765kV) & 2x125 MVA (420kV) Bus Reactors at a suitable location near Bikaner \*

#### **Future provisions at Bikaner-IV PS (excl. scope for present scheme): Space for**

- 765 kV line bays along with switchable line reactors – 6 nos.
- 765kV Bus Reactor along with bay: 1 no.
- 400 kV line bays along with switchable line reactor –4 nos.
- 400 kV line bays–2 nos.
- 400/220kV ICT along with bays -4 nos.
- 400 kV Bus Reactor along with bay: 1 no.
- 400kV Sectionalizer bay: 2 sets
- 220 kV line bays for connectivity of RE Applications -5 nos.
- 220kV Sectionalizer bay: 2 sets
- 220 kV BC (2 nos.) bays and 220 kV TBC (2 nos.) bays

***\*along with provision of 80MVA spare reactor (Single phase) & 500MVA spare transformer unit (Single phase)***

- 220kV line bays (6 nos.) for RE connectivity at Bikaner-IV PS
- 400kV line bays (3 no.) for RE connectivity at Bikaner-IV PS
- 220kV Sectionalizer bay (1 set) along with BC (2 nos.) bays and 220 kV TBC (2 nos.) bays at Bikaner-IV PS
- 400kV Sectionalizer bay (1 set) at Bikaner-IV PS
- STATCOM (2x±300MVA) along with MSC (4x125 MVA) & MSR (2x125 MVA) along with 2 nos. 400kV bays at Bikaner-IV PS
- LILLO of both ckts of 400kV Bikaner II PS- Bikaner III PS (Quad) direct line at Bikaner-IV PS (~20kms)
- Establishment of 765/400 kV, 6x1500 MVA S/s at suitable location near Siwani (Distt. Bhiwani) along with 2x240 MVA (765kV) Bus Reactor & 2x125 MVA (420kV) Bus Reactor\*

**Future provisions at Siwani S/s(excl. scope for present scheme): Space for**

- 765 kV line bays along with switchable line reactors – 6
- 765kV Bus Reactor along with bay: 1 nos.
- 400 kV line bays along with switchable line reactor –4
- 400 kV Bus Reactor along with bays: 1 no.
- 400kV Sectionalizer bay: 1 set

***\*along with provision of 80MVA spare reactor (Single phase) & 500MVA spare transformer unit (Single phase)***

- Bikaner-IV PS – Siwani 765 kV 2xD/c line along with 240 MVA switchable line reactor for each circuit at each end (~260 km)
- Siwani – Jind (PG) 400 kV D/c line (Quad) (~110 km)
- Siwani – Patran (Indi Grid) 400 kV D/c line (Quad) (~160 km) (400kV GIS duct :700m) along with 80 MVA switchable line reactor for each circuit at Siwani S/s end
- Siwani – Fatehabad (PG) 400 kV D/c line (Quad) (~80 km)
- Siwani – Sonipat (PG) 400 kV D/c line (Quad) (~150 km) along with 63 MVA switchable line reactor for each circuit at Siwani S/s end
- STATCOM (2x±300MVA) along with MSC (4x125 MVA) & MSR (2x125 MVA) along with 2 nos. 400kV bays at Siwani S/s
- 400kV Sectionalizer bay (1 set) at at Siwani S/s

As discussed above, for evacuation of power beyond 6GW from Bikaner-IV PS, HVDC from Bikaner complex is planned. For additional power transfer from Bikaner complex, a new substation at suitable location in Bikaner i.e. Bikaner-V is planned. CTU enquired SECI to confirm RE potential for Bikaner-V PS as 14 GW evacuation system is already planned from Bikaner complex (Bikaner-II/III:8GW, Bikaner-IV: 6GW) against 14 GW RE potential (along with 6 GW BESS) in Rajasthan for RE potential identified at Bikaner complex as part of committee report. SECI informed that they will revert on the same in consultation with MNRE at the earliest.

Further as part of 75GW REZ in Rajasthan (as part of 500GW report), 5 GW RE potential (3GW solar, 2 GW wind) along with net dispatch of 2GW considering 2GW BESS was considered at Bhadla complex (Bhadla-IV: 2GW). A comprehensive HVDC scheme is planned for 6GW evacuation from Bikaner-V (4GW) and Bhadla-IV (2GW) PS towards Baripada in Orissa (ER) through HVDC system, for which studies is undergoing for 2029 timeframe and will be taken up in other Joint study meeting. However grant of connectivity shall depend on

application received at Bikaner-V & Bhadla-IV which may differ than Bikaner-V (4GW) & Bhadla-IV (2GW). Details of broad scheme is attached in **Annexure-2**

**B. Transmission system for evacuation of power from Fatehgarh/Barmer Complex as part of Rajasthan REZ Ph-IV (Part-4 :3.5GW)**

**Gist of discussion in Joint study meeting held on 28.12.23**

It was informed that as part of Renewable Energy Zones (REZs) identified by MNRE/SECI with a total capacity of 75 GW REZs in Rajasthan, evacuation system for 13GW was planned at Fatehgarh (5GW) & Barmer (8GW) complex. Transmission scheme for Rajasthan REZ Ph-IV (Part-2:5.5GW) (Jaisalmer/Barmer Complex) was approved in 14th NCT meeting for injection at Fatehgarh-IV PS (4GW) & Barmer-I PS (1.5GW) in Rajasthan and under bidding.

At present connectivity of about 8 GW capacity is already granted/received. For evacuation of power beyond 5.5GW from Fatehgarh-IV PS/Barmer-I PS, hybrid transmission system (EHVAC(3.5GW)+HVDC(6GW)) from Fatehgarh/Barmer complex is planned. Studies were carried out in 2026-27 time frame in solar maximized scenario for EHVAC system and Study files for solar maximized scenario was shared on 20.12.23 with all constituents. Study results were deliberated in above meeting

It was stated in meeting that the EHVAC evacuation system comprises 3.5 GW capacity transmission system from Fatehgarh-IV/Barmer-I (thus making total planned capacity of 9GW (5.5GW+3.5GW)) and 6GW HVDC system from Barmer-II PS (new pooling station is being established as part of HVDC scheme). The 6GW HVDC scheme comprises Barmer-II to Suitable locations in WR/SR through HVDC system.

In the joint study meeting, CTU stated that as per committee report Barmer-II PS was planned for 6GW RE potential (2GW BESS capacity) with 4GW evacuation capacity. In 25<sup>th</sup> CMETS-NR meeting, SECI informed that at present there is no clear visibility for RE projects with BESS before 2027 as award process will take time (1-2 years). In view of that 7.5 GW RE potential (solar) remains untapped due to non-materialisation of BESS capacity (Fatehgarh-IV:4GW+Barmer-I : 1.5GW+Barmer-II: 2GW). Accordingly, it was suggested that 2 GW additional RE potential may be considered for planning of transmission scheme from Barmer-II PS. SECI informed that they will provide their inputs on enhancement of potential at Barmer-II PS (4GW to 6GW) consultation with MNRE and RE developers.

Details of RE potential considered in Fatehgarh/Barmer complex is under:

S.No	Transmission Scheme	RE Potential	Cumulative RE Potential
1	Rajasthan REZ Ph-IV (Part-2:5.5GW) (Jaisalmer/Barmer Complex)  <b>EHVAC system -Under Bidding</b>	5.5GW (Solar)  Fatehgarh-IV: 4 GW Barmer-I: 1.5 GW	<b>5.5GW (Solar)</b>  Fatehgarh-IV: 4 GW Barmer-I: 1.5 GW
2	Rajasthan REZ Ph-IV (Part-4:3.5GW) (Jaisalmer/Barmer Complex)  <b>EHVAC system-Present proposal</b>	3.5 GW (Solar)  Fatehgarh-IV: 1 GW Barmer-I: 2.5 GW	<b>9GW (Solar)</b>  Fatehgarh-IV: 5 GW Barmer-I: 4 GW
3	Rajasthan REZ Ph-IV (Part-5 : 6GW) (Barmer Complex)	6 GW (Solar)  Barmer-II : 6 GW*	<b>15 GW (Solar)</b>  Fatehgarh-IV: 5 GW

S.No	Transmission Scheme	RE Potential	Cumulative RE Potential
	HVDC system towards WR/WR-SR		Barmer-I: 4 GW Barmer-II: 6 GW*

*\*Subject to inputs from MNRE/SECI for enhancement of RE potential at Barmer-II PS*

In the Joint study meeting held on 28.12.2023, following transmission system for evacuation of power from Fatehgarh/Barmer Complex as part of Rajasthan REZ Ph-IV (Part-4 :3.5GW) was proposed

#### **Fatehgarh-IV: 1 GW (Solar), Barmer-I :2.5GW (Solar)**

- Establishment of 765/400kV, 2x1500 MVA S/s at suitable location near Merta (Merta-II Substation) along with 2x125 MVA & 2x240 MVA bus reactor at Merta-II\* S/s
- STATCOM (2x+300MVA) along with MSC (4x125 MVA) & MSR (2x125 MVA) along with 2 nos. 400kV line bays at Barmer-I PS
- Augmentation with 765/400 kV, 2x1500 MVA Transformer (4th & 5th) at Barmer-I PS
- Augmentation of 3x500 MVA (3<sup>rd</sup> to 5<sup>th</sup>), 400/220 kV ICT at Barmer-I PS
- 220kV line bays (4 nos.) for RE connectivity at Barmer-I PS
- 220kV Sectionalization bay (1 set) along with BC (1 nos.) and 220 kV TBC (1 nos.) at Barmer-I PS
- Fatehgarh-IV PS – Barmer-I PS 400kV D/c line (Quad) (~40km)
- Barmer-I PS – Merta-II 765 kV D/c line along with 240 MVA switchable line reactor for each circuit at each end of Barmer-I PS – Merta-II 765 kV D/c line (~320 km)
- Merta-II – Beawar 400 kV D/c line (Quad) (~55 km)
- Merta-II – Dausa 765 kV D/c line along with 240 MVA switchable line reactor for each circuit at each end of Merta-II – Dausa 765 kV D/c line line (~250 km)
- Establishment of 765/400kV, 2x1500 MVA S/s at suitable location near Ghiror (Distt. Mainpuri) along with 2x125 MVA & 2x240 MVA bus reactor at Ghiror S/s (UP)
- Dausa - Ghiror 765 kV D/c line along with 240 MVA switchable line reactor for each circuit at each end of Dausa - Ghiror 765 kV D/c line (~285 km)
- LILO of both ckt of 765 kV Aligarh (PG) -Orai (PG) D/c line (~40 km) at Ghiror S/s along with 240 MVA switchable line reactor for each circuit at Ghiror S/s end of 765 kV Ghiror -Orai D/c line
- LILO of one ckt of 765kV Agra (PG) – Fatehpur(PG) 765kV D/c line at Ghiror along with 240 MVA switchable line reactor at Ghiror S/s end of 765 kV Ghiror -Fatehpur line (~40 kms)

In above meeting, Grid-India enquired about installation of STATCOMs at new pooling stations in Bikaner and Fatehgarh/Barmer complex. CTU stated that at present 3 nos. STATCOMs are already operational at Fatehgarh-II, Bhadla-II & Bikaner-II and 2 nos. STATCOMs at Ramgarh and Fatehgarh-III are under implementation. Additionally, 3 nos. STATCOMs at Bikaner-IV, Siwani and Barmer-I is also planned in proposed schemes (Ph-IV: Part 3 & 4). Additionally, space provision to be kept STATCOM at Merta-II, & Ghiror S/s as part of future scope.

Grid-India stated that proposal is in order, however 400/220kV ICTs (2x315MVA) at Agra (PG) is critically loaded in N-1 contingency. CTU stated that with proposed scheme there is marginally increment (~5MW) in 400/220kV ICT loading in Agra. CTU stated that space is not available for installation of 3rd ICT at Agra(PG) S/s, therefore replacement of ICTs may be considered in future based on real time loadings.

CTU stated that in the present proposal they have optimally utilized the Aligarh-Orai and Fatehpur -Agra high capacity 765kV corridors as the loadings of lines are less in solar maximized scenario. 765/400kV Orai Substation is well connected with WR Grid and Power

from 765/400kV Orai shall be dispersed to load centres of WR through various high capacity lines. CTU stated that they are planning to interconnect proposed Ghiror S/s to nearby UPPTCL substation i.e. 400/220kV Firozabad at 400kV level as part of present scheme. CTU requested UPPTCL to provide space availability for 2 nos. of 400kv line bays at Firozabad S/s. This will also relieve the loading of Agra ICTs and increase resiliency of system. UPPTCL agreed for the same.

UPPTCL requested that studies may be performed with Bhadla-Fatehpur HVDC system to check loadings with proposed system. CTU stated that Bhadla-Fatehpur system is under bidding with scheduled implementation Feb'28 (Pole-1) and therefore not considered in studies, however they will carry out sensitivity case considering HVDC system and commensurate RE generation and will provide to UPPTCL. Same was provided to UPPTCL on 02.01.24.

CEA stated that proposal in order however, studies may be reviewed with UP intra state transmission system and associated RE generation in GEC-II. CTU agreed for the same. CTU enquired SECI and UPPTCL for envisaged RE potential in Bundelkhand region. UPPTCL stated that UPNEDA communicated 10GW RE potential in Bundelkhand region (UP), out of which UPPTCL has planned transmission scheme for evacuation of 4GW solar in intra state and transmission scheme is already approved in GEC-II. CTU stated that they have also received 1200MW solar application in Bundelkhand region for injection at Orai S/s which will be discussed in ensuing CMETS-NR meeting. It was stated that the above 4GW potential (out of 10GW potential) is part of 500GW report, however balance 6GW potential as indicated by UPNEDA is not part of 500GW report, therefore UPPTCL may provide communication to CEA/CTU in 2-3 days, so same can be forwarded to SECI for evaluation of developable RE potential in this region. UPPTCL agreed for the same

Further, UPPTCL informed in the meeting that space is available for 2 nos. of 400kV line bays at Firozabad S/s however, they shall confirm the same after verification. Prima facie loading of 400kV Ghiror- Firozabad D/c line is in order. In view of that CTU included 400kV Ghiror-Firozabad as part of proposed Transmission system for evacuation of power from Rajasthan REZ Ph-IV (Part-4 :3.5 GW) [Fatehgarh/Barmer] Complex. This will also relieve the loading at Agra ICTs and increase resiliency of the system.

Revised study files with proposed changes (considering 400kV Ghiror- Firozabad D/c line & Barmer-I STATCOM as part of proposed scheme) and considering UP intra state solar generation and associated transmission scheme (GEC-II) was circulated on 01.05.24 along with study plots.

#### **Gist of discussion in Joint study meeting held on 09.01.24**

CTU stated that in Joint study meeting held on 28.12.23, Transmission system for evacuation of power from Fatehgarh/Barmer Complex as part of Rajasthan REZ Ph-IV (Part-4 :3.5GW) was in-principally agreed.

Grid-India also stated that the surplus power in NR and WR during solar peak period is flowing towards ER and high loading is observed in 765 kV Ranchi - Dharamjaygarh line and other EHV lines towards ER with higher angular separation after N-1. Due to high loading, low voltages observed in ER region on various EHVAC buses.

CTU stated that based on Grid-India observations, in revised studies, Guzuwaka HVDC is already reversed (1000MW) towards ER and Talchar-Kolar capacity is also kept minimum in forward direction (600-700MW). This will relieve loading of various WR-ER corridors incl. 765kV Ranchi – Dharamjaygarh D/c up to a certain extent.. The files were already sent to

other planning groups (CTU) to review loadings (ER-WR) commensurate to envisaged thermal generation in both the regions.

CTU stated the loading of some of WR-ER corridors are in general high and with proposed scheme (Rajasthan Ph-IV (Part-4 :3.5 GW)), there is marginal increment on above Inter regional links in winter solar maximized scenario. In the next phase of studies (2028-29) with proposed HVDC corridors from NR to ER and NR to WR, loadings will be reviewed, and measures will be taken if required. Grid-India & CEA agreed for the same

CTU enquired about RE potential at Ghiror complex for provision of 220kV scope at Ghiror S/s. SECI replied that solar irradiation level at Ghiror complex is less and at present they are not anticipating RE applications for injection at Ghiror. In view of that it was decided that 220kV future scope shall not be considered at Ghiror for RE injection.

UPPTCL informed that space is available at 400kV Firozabad S/s for interconnection of proposed 400kV Ghiror – Firozabad D/c line and power flow is in order on the above line. CTU requested UPPTCL to provide the above information in the mail at the earliest. Regarding RE potential in Bundelkhand region, UPPTCL stated that they have received inputs from UPNEDA however UPPTCL sought some clarifications as well as some additional inputs from UPNEDA. CTU requested UPPTCL to provide the same at the earliest.

Further CTU enquired for drawl requirement at Merta-II and Ghiror S/s. UPPTCL stated that in view of growing load of UP, space provision may be kept for future drawl requirement at Ghiror S/s, however they will confirm the same on mail. RVPN stated that they will revert with the drawl requirement at Mera-II S/s. No other comments received from any Stakeholders. Revised study files with proposed changes in Ph-IV (Part-3: 6GW) and incorporating stakeholder comments on all India LGB, study files were circulated on 06.05.24 along with study plots.

As discussed earlier, off peak file were circulated on 13.01.24 to all stakeholders and based on voltages specially in Ghiror complex, reactive compensation was reviewed. Result of system studies incorporating observations received from stakeholders is enclosed in **Exhibit-1**

In view of above deliberations, following transmission scheme was agreed in above Joint study meetings (28.12.23 & 09.01.24)

### **Transmission system for evacuation of power from Rajasthan REZ Ph-IV (Part-4 :3.5 GW) [Fatehgarh/Barmer] Complex**

#### **Fatehgarh-IV: 1 GW (Solar), Barmer-I :2.5GW (Solar)**

- Establishment of 765/400kV, 2x1500 MVA S/s at suitable location near Merta (Merta-II Substation) along with 2x125 MVA & 2x240 MVA bus reactor at Merta-II\* S/s

#### **Future provisions at Merta-II S/s(excl. scope for present scheme): Space for**

- 765/400kV ICTs along with bays- 4
- 765 kV line bays along with switchable line reactors – 8
- 765kV Bus Reactor along with bay: 1 nos.
- 400 kV line bays along with switchable line reactor –8
- 400 kV line bays – 2 nos.
- 400 kV Bus Reactor along with bays: 1 no.
- 400kV Sectionalizer bay: 2 sets
- 400/220kV ICT along with bays -6 nos.
- 220 kV line bays for RE injection -8 nos.
- 220kV Sectionalizer bay: 2 set

- 220 kV BC (3 nos.) bays and 220 kV TBC (3 nos.) bays
- 6000 MW,  $\pm 800$  kV Merta (HVDC) [LCC] terminal station (4x1500 MW) along with bays
- STATCOM (2x $\pm$ 300MVA, 4x125MVA MSC, 2x125MVA MSR) along with 400kV bays (2 nos.)

*\*along with provision of 80-MVA & 110MVA spare reactors (Single phase) & 500MVA spare transformer unit (Single phase)*

- STATCOM (2x $\pm$ 300MVA) along with MSC (4x125 MVA) & MSR (2x125 MVA) along with 2 nos. 400kV bays at Barmer-I PS
- Augmentation with 765/400 kV, 2x1500 MVA Transformer (4th & 5th) at Barmer-I PS
- Augmentation of 5x500 MVA (5<sup>th</sup> to 9<sup>th</sup>), 400/220 kV ICTs at Barmer-I PS
- 220kV line bays (6 nos.) for RE connectivity at Barmer-I PS
- 220kV Sectionalizer bay (1 set) along with 220 kV BC (1 nos.) bay and 220 kV TBC (1 nos.) bay at Barmer-I PS
- 400kV Sectionalizer bay (1 set) at Barmer-I S/s
- Fatehgarh-IV PS (Sec-2) – Barmer-I PS 400kV D/c line (Quad) (~25km)
- Barmer-I PS – Merta-II 765 kV D/c line along with 240 MVA switchable line reactor at Barmer-I PS end and 330MVA switchable line reactor at Merta-II PS end for each circuit of Barmer-I PS – Merta-II 765 kV D/c line (~320 km)
- Merta-II – Beawar 400 kV D/c line (Quad) (~55 km)
- Merta-II – Dausa 765 kV D/c line along with 240 MVA switchable line reactor for each circuit at each end of Merta-II – Dausa 765 kV D/c line line (~250 km)
- Establishment of 765/400kV, 2x1500 MVA S/s at suitable location near Ghiror (Distt. Mainpuri) along with 2x125 MVA & 2x240 MVA bus reactor at Ghiror S/s (UP)

**Future provisions at Ghiror S/s\*\* (excl. scope for present scheme): Space for**

- 765/400kV ICTs along with bays- 4
- 765 kV line bays along with switchable line reactors – 6
- 765kV Bus Reactor along with bay: 1 nos.
- 400 kV line bays along with switchable line reactor –6
- 400 kV Bus Reactor along with bays: 1 no.
- 400kV Sectionalizer bay: 1 set
- 400/220kV ICT along with bays -4 nos.
- 220 kV line bays for drawl -6 nos.
- 220kV Sectionalizer bay: 1 set
- 220 kV BC (2 nos.) bay and 220 kV TBC (2 nos.) bay
- STATCOM (2x $\pm$ 300MVA, 4x125MVA MSC, 2x125MVA MSR) along with 400kV bays (2 nos.)

*\*along with provision of 80MVA spare reactor (Single phase) & 500MVA spare transformer unit (Single phase)*

*\*\*Drawl requirement at Ghiror S/s to be confirmed by UPPTCL, accordingly future scope will be finalized*

- Dausa - Ghiror 765 kV D/c line along with 240 MVA switchable line reactor for each circuit at each end of Dausa - Ghiror 765 kV D/c line (~285 km)
- LILO of both ckt of 765 kV Aligarh (PG) -Orai (PG) D/c line (~40 km) at Ghiror S/s along with 240 MVA switchable line reactor for each circuit at Ghiror S/s end of 765 kV Ghiror -Orai D/c line
- LILO of one ckt of 765kV Agra (PG) – Fatehpur(PG) 765kV D/c line at Ghiror along with 240 MVA switchable line reactor at Ghiror S/s end of 765 kV Ghiror -Fatehpur line (~40 kms)
- 400kV Ghiror-Firozabad (UPPTCL) D/c line (Quad) (~40 kms)

It was also deliberated that HVDC system is to be planned for additional 6GW at Barmer complex with 2029 implementation schedule. Studies for HVDC scheme is undergoing and will be taken up in next Joint study meeting. Details of broad HVDC scheme is enclosed in

**Annexure-2**





## Alternative-I

### A. Ph-IV (Part-3 : 3.6GW) at Bikaner-IV PS (Already agreed in 25<sup>th</sup> CMETS-NR meeting)

- Establishment of 4x1500 MVA, 765/400 kV & 4x500 MVA, 400/220 kV Bikaner-IV Pooling Station along with 2x240 MVar (765kV) & 2x125 MVar (420kV) Bus Reactors at a suitable location near Bikaner
- STATCOM (2x±300MVar) along with MSC (4x125 MVar) & MSR (2x125 MVar) along with 2 nos. 400kV line bays at Bikaner-IV PS
- 220kV line bays (5 nos.) for RE connectivity at Bikaner-IV PS
- 400kV line bays (1 no.) for RE connectivity at Bikaner-IV PS
- 220kV Sectionalization bay (1 set) along with BC (2 nos.) and 220 kV TBC (2 nos.) at Bikaner-IV PS
- 400kV Sectionalization bay (1 set) at Bikaner-IV PS
- LILO of both ckts of 400kV Bikaner II PS- Bikaner III PS (Quad) at Bikaner-IV PS
- Establishment of 765/400 kV, 2x1500 MVA S/s at suitable location near Churu along with 2x240 MVar (765kV) Bus Reactor & 2x125 MVar (420kV) Bus Reactor
- Bikaner-IV PS – Churu 765 kV D/c line along with 240 MVar switchable line reactor for each circuit at Bikaner-IV PS end (~180 km)
- LILO of one ckt of 765 kV Sikar-II (PG) -Khetri (PG) D/c line at Churu S/s (~90 km)
- Churu – Fatehabad (PG) 400 kV D/c line (Quad) along with 63 MVar switchable line reactor for each circuit at Churu S/s end (~150 km)
- Establishment of 765/400 kV, 3x1500 MVA S/s at suitable location near Siwani (Distt. Bhiwani) along with 2x240 MVar (765kV) Bus Reactor & 2x125 MVar (420kV) Bus Reactor
- Siwani – Churu 765 kV D/c line (~95 km)
- Siwani – Jind (PG) 400 kV D/c line (Quad Moose) (~110 km)
- Siwani – Patran (Indi Grid) 400 kV D/c line (Quad) (~160 km) (400kV GIS duct :700m) along with 80 MVar switchable line reactor for each circuit at Siwani S/s end

### B. Ph-IV (Part-3a : 2.4GW) at Bikaner-IV PS (New Proposal)

- Augmentation of 1x1500 MVA(5th), 765/400 kV ICT at Bikaner-IV Pooling Station
- Augmentation of 3x500 MVA (5th to 7th), 400/220 kV ICT at Bikaner-IV Pooling Station<sup>#</sup>
- 220kV line bays (3 nos.) for RE connectivity at Bikaner-IV PS<sup>#</sup>
- Bikaner-IV PS – Siwani 765 kV D/c line along with 240 MVar switchable line reactor for each circuit at each end (~260 km)
- Augmentation of 765/400 kV, 2x1500 MVA ICT (4<sup>th</sup> & 5<sup>th</sup>) at Siwani S/s
- Siwani – Sonipat (PG) 400 kV D/c line (Quad Moose) (~150 km) along with 63 MVar switchable line reactor for each circuit at Siwani S/s end

**# To be finalized as per application received**

## Alternative-II

### Bikaner-IV: 6 GW (Solar)

- Establishment of 5x1500 MVA, 765/400 kV & 7x500 MVA<sup>#</sup>. 400/220 kV Bikaner-IV Pooling Station along with 2x240 MVar (765kV) & 2x125 MVar (420kV) Bus Reactors at a suitable location near Bikaner
- STATCOM (2x±300MVar) along with MSC (4x125 MVar) & MSR (2x125 MVar) along with 2 nos. 400kV line bays at Bikaner-IV PS
- 220kV line bays (8 nos.) for RE connectivity at Bikaner-IV PS #
- 400kV line bays (3 no.) for RE connectivity at Bikaner-IV PS

- 220kV Sectionalization bay (1 set) along with BC (2 nos.) and 220 kV TBC (2 nos.) at Bikaner-IV PS
- 400kV Sectionalization bay (1 set) at Bikaner-IV PS
- LILO of both ckts of Bikaner II PS- Bikaner III PS (Quad) at Bikaner-IV PS
- Establishment of 765/400 kV, 6x1500 MVA S/s at suitable location near Siwani (Distt. Bhiwani) along with 2x240 MVA (765kV) Bus Reactor & 2x125 MVA (420kV) Bus Reactor
- Bikaner-IV PS – Siwani 765 kV 2xD/c line along with 240 MVA switchable line reactor for each circuit at each end (~260 km)
- Siwani – Jind (PG) 400 kV D/c line (Quad Moose) (~110 km)
- Siwani – Patran (Indi Grid) 400 kV D/c line (Quad) (~160 km) (400kV GIS duct :700m) along with 80 MVA switchable line reactor for each circuit at Siwani S/s end
- Siwani – Fatehabad (PG) 400 kV D/c line (Quad) (~80 km)
- Siwani – Sonipat (PG) 400 kV D/c line (Quad Moose) (~150 km) along with 63 MVA switchable line reactor for each circuit at Siwani S/s end
- STATCOM (+300MVA) along with MSC (2x125 MVA) & MSR (1x125 MVA) along with 2 nos. 400kV line bays at Siwani S/s

*# To be finalized as per application received*

**A. Proposed Transmission system for evacuation of power from Rajasthan REZ Ph-IV (Part-5 :6 GW) [Barmer Complex] Barmer-II : 6GW (Solar)**

- Establishment of 400/220kV, 4x500MVA S/s at suitable location near Barmer (Barmer-II Substation) along with 2x125 MVar bus reactor

**Future provisions at Barmer-II S/s:**

**Space for**

- 400 kV line bays along with switchable line reactor –6
- 400 kV line bays –4
- 400 kV Bus Reactor along with bays: 1 no.
- 400/220 kV ICT along with bays -10 Nos.
- 400 kV Sectionalization bays: 2 sets
- 220 kV line bays for connectivity of RE Applications -15 Nos.
- 220kV Sectionalization bay: 3 sets
- 220 kV BC (4 Nos.) & TBC (4 Nos.)
  
- 220kV line bays (4 nos.) for RE connectivity at Barmer-II PS
- Barmer-I PS – Barmer-II PS 400kV D/c line (Quad)
- Establishment of 6000 MW,  $\pm$  800 kV Barmer-II (HVDC) [LCC] terminal station (4x1500 MW) at a suitable location near Barmer-II substation
  - 400/33 kV, 2x50 MVA transformers for exclusively supplying auxiliary power to HVDC terminal.
  - 400kV bus sectionaliser -2 nos (1 Set) at Barmer-II (HVDC) station
- Establishment of 6000 MW,  $\pm$ 800 kV (HVDC) [LCC] terminal station (4x1500 MW) at suitable location in WR/SR or 2 nos. 3000MW,  $\pm$ 800 kV (HVDC) [LCC] terminal stations (Multi terminal) at suitable location(s) in WR/SR
- $\pm$ 800 kV HVDC line (Hexa lapwing) between Barmer-II (HVDC) & WR /SR (HVDC) (with Dedicated Metallic Return)
- Associated EHVAC system strengthening in WR/SR

**Exact HVDC terminal points in WR/WR-SR boundary are proposed to be identified based on detailed system studies involving stakeholders from NR, WR & SR. Decision on HVDC technology i.e. LCC/ VSC will be carried out at later stage during joint study meeting**

**B. Proposed Transmission system for evacuation of power from Rajasthan REZ Ph-IV (Part-6 :6 GW) [Bhadla/Bikaner Complex]**

**Bhadla-IV: 2 GW (Solar), Bikaner-V : 4GW (Solar)**

- Establishment of 6000 MW,  $\pm$  800 kV Merta (HVDC) [LCC] terminal station (4x1500 MW) in Merta-II substation
  - 400/33 kV, 2x50 MVA transformers for exclusively supplying auxiliary power to HVDC terminal.
  - 400kV bus sectionaliser -2 nos (1 Set) at Merta-II (HVDC) station
  
- Establishment of 765/400kV, 4x1500 MVA S/s & 400/220kV 4x500MVA pooling station at suitable location near Bikaner (Bikaner-V PS) along with 2x125 MVar & 2x240 MVar bus reactor

## **Future provisions**

### **Space for**

- 765/400kV ICTs along with bays- 2
- 765 kV line bays along with switchable line reactors – 10
- 765kV Bus Reactor along with bay: 1 nos.
- 400 kV line bays along with switchable line reactor –10
- 400kv line bays : 4 nos.
- 400 kV Bus Reactor along with bays: 1 no.
- 400kV Sectionalization bay: 2 sets
- 400/220kV ICT along with bays -6 nos.
- 220 kV line bays - 10 nos.
- 220kV Sectionalization bay: 3 sets

***\*along with provision of 80-MVAR spare reactor (Single phase) & 500MVA spare transformer unit (Single phase)***

- 220kV line bays (4 nos.) for RE connectivity at Bikaner-V PS
- Bikaner-V PS – Merta-2 765KV D/c line (~ 200kms) along with 240 MVAR switchable line reactor for each circuit at each end of Bikaner-V PS – Merta-2 765KV D/c line
- Establishment of 765/400kV, 3x1500 MVA S/s & 400/220kV 3x500MVA pooling station at suitable location near Bhadla (Bhadla-IV PS) along with 2x125 MVAR & 2x240 MVAR bus reactor

## **Future provisions**

### **Space for**

- 765/400kV ICTs along with bays- 3
- 765 kV line bays along with switchable line reactors – 10
- 765kV Bus Reactor along with bay: 1 nos.
- 400 kV line bays along with switchable line reactor –10
- 400kv line bays : 4 nos.
- 400 kV Bus Reactor along with bays: 1 no.
- 400kV Sectionalization bay: 2 sets
- 400/220kV ICT along with bays -7 nos.
- 220 kV line bays - 10 nos.
- 220kV Sectionalization bay: 3 sets

- Bhadla-IV PS – Merta-II 765KV D/c line (~ 250kms) along with 240 MVAR switchable line reactor for each circuit at each end of Bhadla-IV PS – Merta-2 765KV D/c line
- Augmentation of 765/400 kV, 3x1500 MVA ICTs at Merta-II S/s
- 6000 MW, ±800 kV Merta (HVDC) [LCC] terminal station (4x1500 MW)
- Establishment of 6000 MW, ±800 kV Baripada (HVDC) [LCC] terminal station (4x1500 MW) at suitable location near Baripada (Distt. Mayurbhanj)
- ±800 kV HVDC line (Hexa lapwing) between Merta-II (HVDC) & Baripada (HVDC) (with Dedicated Metallic Return) - 1600 km

**EHVAC system beyond Baripada (HVDC) S/s is under planning.**

Transmission scheme for Rajasthan REZ Ph-IV (Part-3 :6GW (Bikaner complex) and Ph-IV (Part-4 :3.5GW (Fatehgarh/Barmer complex)

Summer Solar Max Scenario  
Base Case

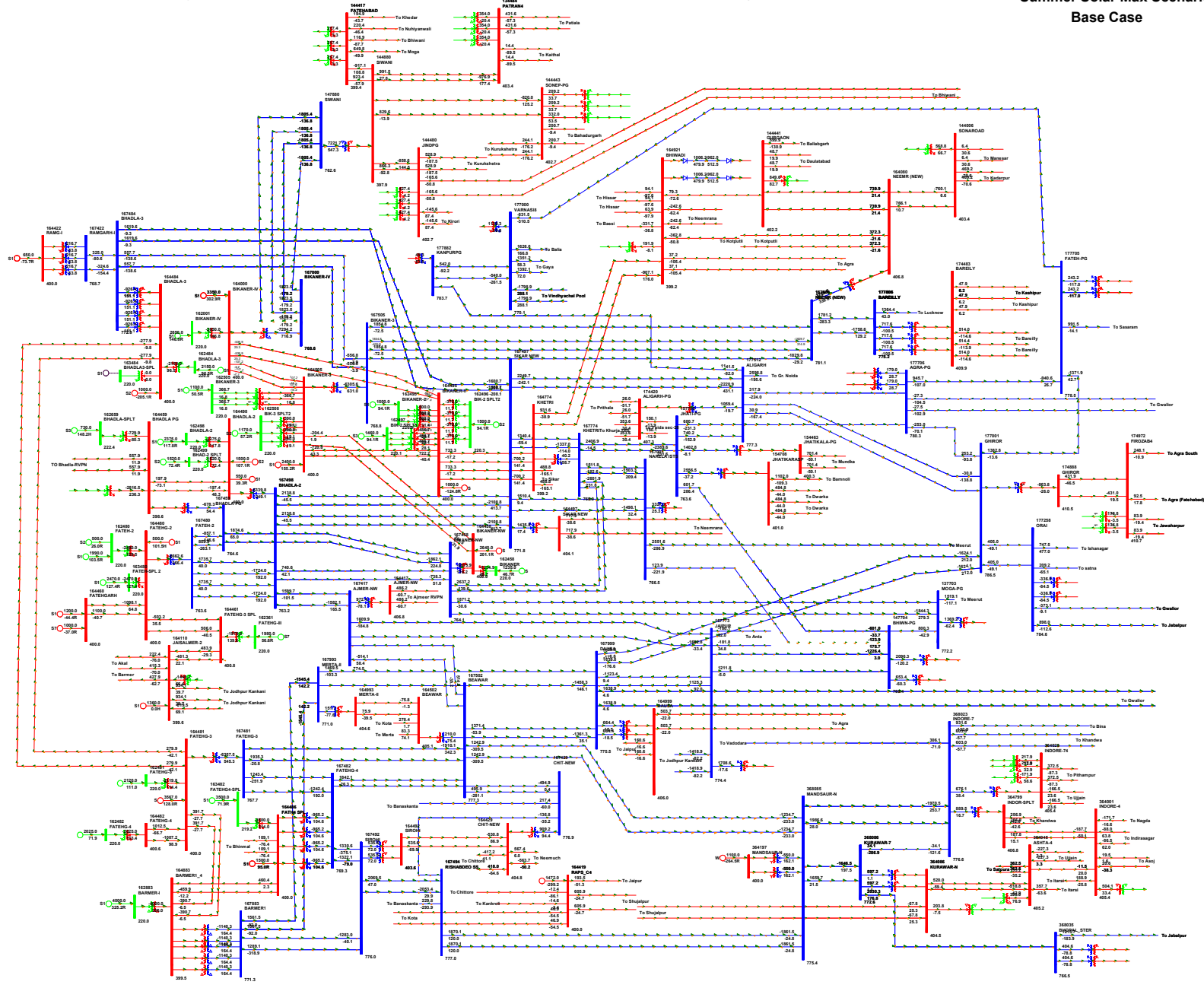

Transmission scheme for Rajasthan REZ Ph-IV (Part-3 :6GW (Bikaner complex) and Ph-IV (Part-4 :3.5GW (Fatehgarh/Barmer complex)

Winter Solar Max Scenario  
Base Case

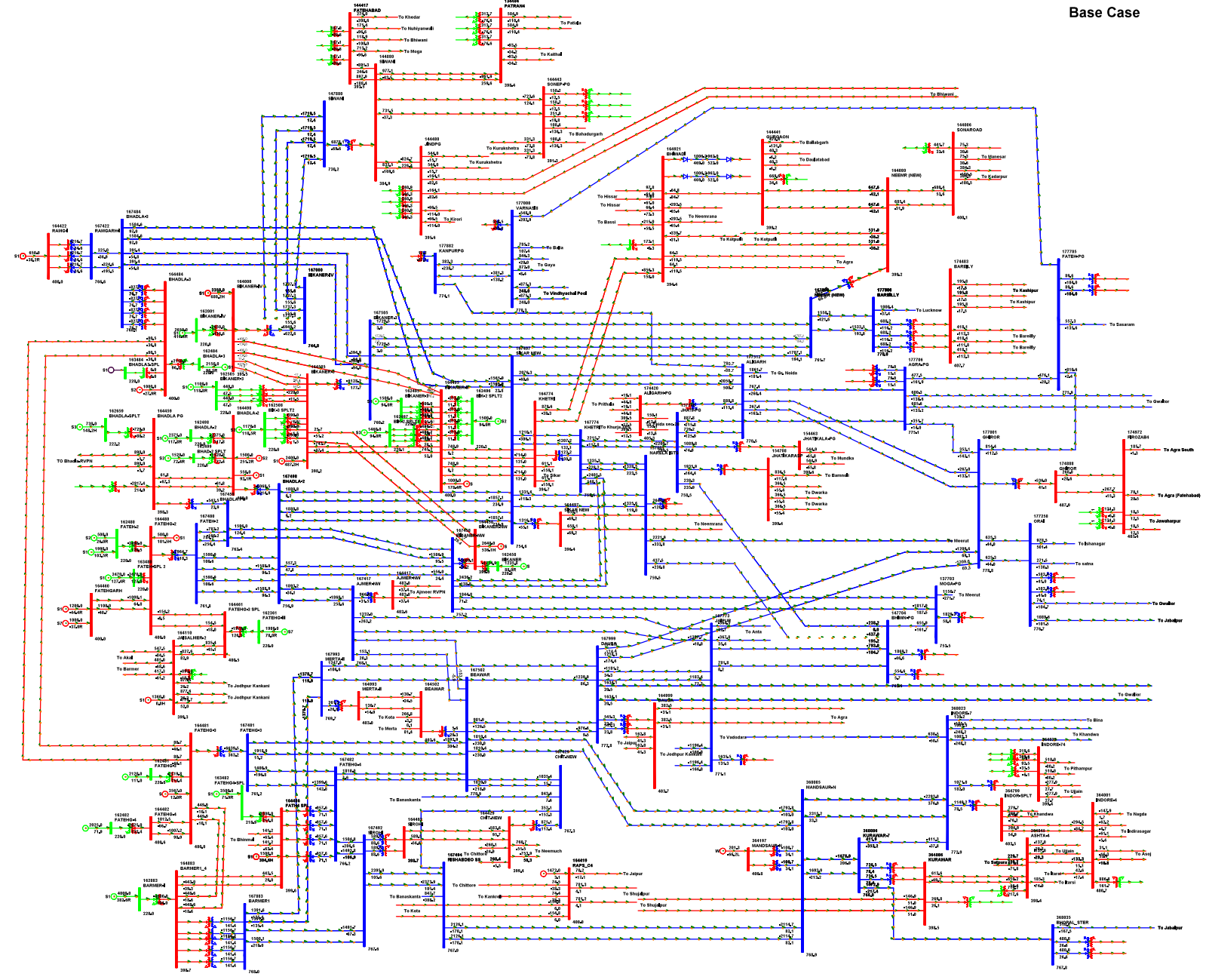



**Transmission system for evacuation of power from Rajasthan REZ Ph-IV (Part-3 :6GW) [Bikaner complex]**

S. No.	Items	Details
1.	Name of Scheme	<b>Transmission system for evacuation of power from Rajasthan REZ Ph-IV (Part-3 : 6GW) [Bikaner complex]</b>
2.	Scope of the scheme	<p><b>Transmission system for evacuation of power from Rajasthan REZ Ph-IV (Part-3 : 6GW)</b></p> <p><b>Bikaner-IV: 6 GW (Solar)</b></p> <p>➤ Establishment of 6x1500 MVA, 765/400 kV &amp; 6x500 MVA, 400/220 kV Bikaner-IV Pooling Station along with 2x240 MVA (765kV) &amp; 2x125 MVA (420kV) Bus Reactors at a suitable location near Bikaner *</p> <p><b>Future provisions at Bikaner-IV PS (excl. scope for present scheme): Space for</b></p> <ul style="list-style-type: none"> <li>▪ 765 kV line bays along with switchable line reactors – 6 nos.</li> <li>▪ 765kV Bus Reactor along with bay: 1 no.</li> <li>▪ 400 kV line bays along with switchable line reactor –4 nos.</li> <li>▪ 400 kV line bays–2 nos.</li> <li>▪ 400/220kV ICT along with bays -4 nos.</li> <li>▪ 400 kV Bus Reactor along with bay: 1 no.</li> <li>▪ 400kV Sectionalizer bay: 2 sets</li> <li>▪ 220 kV line bays for connectivity of RE Applications -5 nos.</li> <li>▪ 220kV Sectionalizer bay: 2 sets</li> <li>▪ 220 kV BC (2 nos.) bays and 220 kV TBC (2 nos.) bays</li> </ul> <p><b>*along with provision of 80MVA spare reactor (Single phase) &amp; 500MVA spare transformer unit (Single phase)</b></p> <p>➤ 220kV line bays (6 nos.) for RE connectivity at Bikaner-IV PS</p> <p>➤ 400kV line bays (3 no.) for RE connectivity at Bikaner-IV PS</p> <p>➤ 220kV Sectionalizer bay (1 set) along with BC (2 nos.) bays and 220 kV TBC (2 nos.) bays at Bikaner-IV PS</p> <p>➤ 400kV Sectionalizer bay (1 set) at Bikaner-IV PS</p> <p>➤ STATCOM (2x±300MVA) along with MSC (4x125 MVA) &amp; MSR (2x125 MVA) along with 2 nos. 400kV bays at Bikaner-IV PS</p> <p>➤ LILO of both ckts of 400kV Bikaner II PS- Bikaner III PS (Quad) direct line at Bikaner-IV PS (~20kms)</p> <p>➤ Establishment of 765/400 kV, 6x1500 MVA S/s at suitable location near Siwani (Distt. Bhiwani) along with 2x240 MVA (765kV) Bus Reactor &amp; 2x125 MVA (420kV) Bus Reactor*</p> <p><b>Future provisions at Siwani S/s(excl. scope for present scheme): Space for</b></p> <ul style="list-style-type: none"> <li>▪ 765 kV line bays along with switchable line reactors – 6</li> <li>▪ 765kV Bus Reactor along with bay: 1 nos.</li> <li>▪ 400 kV line bays along with switchable line reactor –4</li> <li>▪ 400 kV Bus Reactor along with bays: 1 no.</li> <li>▪ 400kV Sectionalizer bay: 1 set</li> </ul>



S. No.	Items	Details
		<p>*along with provision of 80MVAR spare reactor (Single phase) &amp; 500MVA spare transformer unit (Single phase)</p> <ul style="list-style-type: none"> <li>➤ Bikaner-IV PS – Siwani 765 kV 2xD/c line along with 240 MVAR switchable line reactor for each circuit at each end (~260 km)</li> <li>➤ Siwani – Jind (PG) 400 kV D/c line (Quad) (~110 km)</li> <li>➤ Siwani – Patran (Indi Grid) 400 kV D/c line (Quad) (~160 km) (400kV GIS duct :700m) along with 80 MVAR switchable line reactor for each circuit at Siwani S/s end</li> <li>➤ Siwani – Fatehabad (PG) 400 kV D/c line (Quad) (~80 km)</li> <li>➤ Siwani – Sonipat (PG) 400 kV D/c line (Quad) (~150 km) along with 63 MVAR switchable line reactor for each circuit at Siwani S/s end</li> <li>➤ STATCOM (2x±300MVAR) along with MSC (4x125 MVAR) &amp; MSR (2x125 MVAR) along with 2 nos. 400kV bays at Siwani S/s</li> <li>➤ 400kV Sectionalizer bay (1 set) at at Siwani S/s</li> </ul>
3.	<b>Depiction of the scheme on Transmission Grid Map</b>	Attached at <b>Exhibit-I</b>
4.	<b>Upstream/downstream system associated with the scheme</b>	<p>400/220kV Jind (PG), Patran (Indi Grid), Fatehabad (PG) &amp; Sonipat (PG) are existing ISTS substation. 400kV Fatehabad S/s is interconnected with Khedar, Bhiwani and Nuhiyanwali S/s whereas Patran S/s is connected with Patiala and Kaithal S/s. 400kV Jind S/s is interconnected with Kirori, Kurukshetra and Bhiwani S/s. 400kv Sonipat S/s is interconnected with Kurukshetra &amp; Bahadurgarh S/s.</p> <p>765/400/220kV Bikaner-III PS is under implementation by Bikaner-III Neemrana transmission ltd. (POWERGRID) and proposed to be interconnected with Neemrana-II S/s through 765kV 2xD/c lines and Bikaner (PG) and Bikaner-II S/s through 400kV D/c lines. Bikaner-II PS S/s is existing substation of POWERGRID Bikaner transmission system Ltd. (POWERGRD) interconnected with Khetri S/s through 2xD/c lines at 400kv level.</p>
5.	<b>Objective / Justification</b>	<ol style="list-style-type: none"> <li>1.The present scheme comprises Transmission system for evacuation of power from Rajasthan REZ Ph-IV (Part-3 ) from Bikaner complex (Bikaner-IV: 6GW)</li> <li>2. Joint Study Meeting(s) were held in virtual mode on 28.12.23 and 09.01.24 with SECI, CEA, GRID-INDIA, RVPN, HVPN, PSTCL, UPPTCL and other STUs of Northern region to discuss the Transmission system for evacuation of power from Bikaner Complex as part of Rajasthan REZ Ph-IV (Part-3) scheme.</li> <li>3. In 25th CMETS-NR meeting for about 3.6 GW (Solar) as part of Rajasthan REZ Ph-IV (Part-3 :3.6GW) (Bikaner Complex) for injection at Bikaner-IV in Rajasthan. The scheme was approved in 48th TCC/70th NRPC meeting held on 17<sup>th</sup> - 18<sup>th</sup> Nov'23</li> </ol> <p><b>Estimated Cost : Rs 8600Cr (Rs 2.4Cr/MW)</b></p> <p>Based on subsequent discussions &amp; studies, a comprehensive optimal scheme for 6 GW RE potential (Bikaner) is evolved with</p>

S. No.	Items	Details
		<p>lesser cost (Rs 1.9 Cr/MW as compared to earlier Rs 2.4 Cr/MW). Background of the modified transmission scheme is enclosed.</p> <p><b>Gist of discussion in Joint study meeting held on 28.12.23</b></p> <p>4. In the meeting, it was stated that at present connectivity of about 6 GW is already agreed/received against its total potential (6GW). As part of EHVAC system, evacuation system is planned for 2.4GW capacity (thus makes total capacity of 6 GW at Bikaner-IV PS). For EHVAC system, studies were carried out in 2026-27 time frame in solar maximized scenario and Study files for solar maximized scenario was shared on 20.12.23 with all constituents. Following transmission scheme is proposed for evacuation of power from Rajasthan REZ Ph-IV (Part-3a :2.4GW) [Bikaner complex]</p> <ul style="list-style-type: none"> <li>➤ Bikaner-IV PS – Churu 765 kV D/c line (2<sup>nd</sup>)</li> <li>➤ LILO of other ckt of 765 kV Sikar-II (PG) -Khetri (PG) D/c line at Churu S/s</li> <li>➤ Siwani – Sonipat (PG) 400 kV D/c line (Quad Moose)</li> </ul> <p>5. In the meeting, CEA stated that with Phase-IV Part-3a (2.4GW) proposed scheme, there will be no requirement of 765/400kV Churu S/s &amp; associated interconnections, which were earlier agreed in 25th CMETS-NR meeting as part of Phase-IV Part 3 (3.6GW) scheme.</p> <p>6. CEA stated that in the earlier agreed Phase-IV Part 3 (3.6 GW) scheme, Churu S/s &amp; associated transmission scheme (LILO of one ckt of 765 kV Sikar-II (PG) -Khetri (PG) D/c line at Churu S/s and Churu- Fatehabad (PG) 400 kV D/c line) was considered to address issue on synchronization of line after corridor outage (765kV Bikaner-IV-Siwani D/c line) in N-1-1/N-2 in peak solar hours as emphasized by Grid-India. CEA stated that in place of Bikaner-IV – Churu D/c line, a parallel corridor towards Siwani S/s i.e. 765kV Bikaner-IV- Siwani D/c line may be considered for additional 2.4GW evacuation of power as part of scheme. With the above parallel 765kV corridor i.e. 765kV Bikaner-IV – Siwani D/c line, angular stability issue under N-1-1 contingency will be resolved as 4 nos. of 765kV circuits are available towards Siwani S/s. Further in future, if there is requirement of establishment of Churu S/s, Bikaner-IV – Siwani D/c line may be LILOed at Churu S/s.</p> <p>7. Further, it was deliberated that Transmission system for evacuation of power from Bikaner Complex as part of Rajasthan REZ Ph-IV (Part-3 :3.6GW) is being taken up for approval in next NCT. In view of that both the schemes viz Ph-IV: Part 3 (3.6GW) &amp; Ph-IV: Part 3a (2.4GW)) may be considered comprehensively for 6GW evacuation.</p> <p>8. CTU stated that they will review the proposal based on CEA observations and deliberations in meeting and evaluate various alternatives (with and wo Churu S/s) in a comprehensive manner. Accordingly, the scheme will be further deliberated and finalized in next Joint study meeting.</p> <p><b>Gist of discussion in Joint study meeting held on 09.01.24</b></p>

S. No.	Items	Details
		<p>9. As per deliberation held in Joint study meeting held on 28.12.23, CTU examined both the proposals as below with two alternatives</p> <ul style="list-style-type: none"> <li>• <b>Alternative-1</b> : Bikaner-IV- Churu- Siwani 765kV D/c &amp; Bikaner-IV- Siwani 765kV D/c &amp; associated transmission interconnection at Churu S/s i.e. LILO of one ckt of 765 kV Sikar-II (PG) -Khetri (PG) D/c line at Churu S/s and Churu- Fatehabad (PG) 400 kV D/c line &amp; onwards 400kV transmission system from Siwani S/s (Towards Jind, Patran, Sonipat)</li> <li>• <b>Alternative-2</b>: Bikaner-IV- Siwani 765kV 2xD/c line &amp; onwards 400kV transmission system from Siwani S/s (Towards Jind, Patran, Fatehabad, Sonipat)</li> </ul> <p>10. It was stated that in place of LILO of one ckt of 765 kV Bikaner-III -Neemrana-II D/c line at Bikaner-IV PS, LILO of both ckts of 400kV Bikaner II- Bikaner-III D/c line (Quad) at Bikaner-IV is proposed which will relieve the ICT loadings at Bikaner(PG) &amp; Bikaner-III PS and increase the operational margin on above ICTs. Additionally, STATCOM at Siwani (+300MVar) is proposed in Alternate-2 to mitigate low voltage issue.</p> <p>11. Further, Observations were received on 04.01.24 from Grid-India and CEA on both the alternatives for transmission system for evacuation of power from Bikaner complex as part of Rajasthan REZ Ph-IV (Part-3). Major observations are as under</p> <p><b>A. <u>Grid-India Observations/Comments</u></b></p> <ul style="list-style-type: none"> <li>• During peak solar period, voltages at Siwani (730kV) and Bikaner-IV (740kV) are very low even after taking B/Rs out. If line reactors are to be taken out of service for maintaining voltages, the same needs to be mentioned along with the scheme.</li> <li>• Considering the identified solar potential at Churu by SECI, establishment of Churu substation will help in tapping the solar generation in that complex. CTUIL may clarify its plan and the timelines for establishing the ISTS Churu substation, if the same is not being taken up right now.</li> </ul> <p>Additionally, Grid-India in 25th CMETS-NR meeting opined that in case of direct interconnection of Bikaner-IV to Siwani i.e. not considering 765/400kV Churu in between and onward transmission system, the Transmission system is kind of radial system connected with RE generation pocket and poses stability issues in various operational scenarios in future. Further Grid-India also requested to share Study cases for off peak scenarios. Other study related comments received from Grid-India was also deliberated in above Joint study meeting</p> <p><b>B. <u>CEA Observations/Comments</u></b></p> <ul style="list-style-type: none"> <li>• Power flow in both the alternatives seems to be in order. Transmission system requirement is less in Alt 2. This would result in saving of hundreds of crore.</li> <li>• In Alt 2, with Bikaner-IV- Siwani 765 kV 2xD/c line, issue of synchronization of line after corridor outage (765 kV Bikaner-IV- Siwani D/c line) in N-1-1/N-2 in peak solar hours as highlighted by Grid-India gets resolved.</li> </ul>

S. No.	Items	Details
		<ul style="list-style-type: none"> <li>• As intimated by CTUIL, connectivity applications of 5.4 GW RE has already been received against potential of 6 GW. Therefore, a comprehensive scheme for 6 GW RE evacuation could be implemented.</li> <li>• In view of the above, Alt 2 seems to be preferable at present. Churu substation could be implemented in future, if required, with LILO of Bikaner-IV- Siwani 765 kV line to cater to the potential in Churu district.</li> </ul> <p>12. CTU analysed both the alternatives with above changes and observations are as under :</p> <ul style="list-style-type: none"> <li>• <b>Estimated Cost of scheme is about 12% lower (about Rs 1200 Cr) in Alt-2 than Alt-1</b></li> <li>• In Alt-2, due to longer line length, under N-1 contingency of 765kV Bikaner-IV-Siwani , voltage dipping will be higher (about 10kV than Alt-1) and in the range of 730-740kV considering STATCOM at Bikaner-IV under various operating scenario. In above scenario STATCOM (<math>\pm 300</math>MVAR) at Siwani may also be required (in case of operational difficulty of line reactors switching on EHVAC lines in RE pockets).</li> <li>• With Alt-2, Churu Substation may be planned with future transmission proposals i.e. Bikaner-V, other strengthening schemes based on requirement. Therefore, RE evacuation from Churu S/s will only be possible at later stage (beyond 2027) in Alt-2.</li> <li>• Comprehensive scheme for 6GW will be implemented with <b>tentative timeline of Sep'26 in Alt-2, however in Alt-1 tentative timeline for part scheme (3.6GW) was Jul'26</b></li> </ul> <p>13. Revised study files with proposed changes (LILO of both ckts of 400kV Bikaner II- Bikaner-III D/c line at Bikaner-IV PS in place of LILO of one ckt of 765 kV Bikaner-III -Neemrana-II D/c line at Bikaner-IV PS &amp; Siwani STATCOM (in Alt-2)) was circulated on 06.05.24 along with study plots.</p> <p>14. SECI stated that Churu complex was not identified in solar potential zone as part of 500GW report and thereafter potential was indicated only because the substation was planned as part of agreed Bikaner-IV transmission scheme (3.6GW), however no response from RE developers is yet received to assess &amp; harness RE potential at Churu complex. CTU stated that in above case till no confirmation received from SECI, RE potential at Churu will not be considered and may be evolved based on SECI inputs at later stage.</p> <p>15. Grid-India stated that in June solar scenario studies, pf of Punjab/Haryana load is considered near to 0.99 pf which is very optimistic. However, in real time they have faced voltage dipping issues in Punjab and Haryana intra state network and interstate network (incident to intra state) due to high reactive power drawl in paddy season. This Intra state reactive support may further reduce in paddy season due to envisaged hydro generation from J&amp;K/HP and solar generation from Rajasthan.</p> <p>16. CTU enquired to Grid-India about capacitive support by STUs/DISCOMs in real time to improve load pf and mitigate voltage dipping issues in peak loading season. Grid-India stated that in real time capacitor bank support is available in</p>

S. No.	Items	Details
		<p>Punjab, however in Haryana low voltage issue is still persist in June-July peak loading season.</p> <p>17. CTU stated that in the integrated planning of transmission system, reactive power (MVAR) drawl/absorption requirement at load end to be compensated at intra state network level only and ISTS system is not supposed to be planned to compensate MVAR injection/ drawl from intra state network under various operating scenario as it will also increase losses due to MVAR flow to downstream network from upstream network which is not desirable. In view of that load pf (&gt;0.98pf) may be maintained by STUs/DISCOMs specially in Punjab &amp; Haryana through new capacitive banks, if required and also provide progress of installing new capacitors in monthly OCC/NRPC meetings.</p> <p>18. Considering above, it was decided that STUs specially Haryana may assess the reactive compensation requirement for peak load season in next 2-3 years and may take necessary actions to maintain pf and mitigating low voltage issues in intra state network. HVPN told that they have planned capacitor banks installation at downstream network.</p> <p>19. Grid-India highlighted the voltage dipping issue at Siwani substation (~730KV) in N-1 contingency. The voltage will further decreases to 725kV, with no STATCOM reactive support (STATCOM support reserved for dynamic support only).CEA stated that line reactors on EHVAC lines can be switched off during low voltage as it will give direct relief to improve voltage to 15-20kV, however operational difficulties in switching on/off of line reactors may be deliberated. Further STATCOM at Siwani S/s may be considered +600MVAR (earlier +300MVAR proposed in scheme) along with MSC/MSR to provide voltage support.</p> <p>20. Grid-India stated that earlier, voltage in Fatehgarh complex was observed up to 720kV in peak solar hours and under such condition, sequential line reactor switching was carried out in for volage control, however they have faced resistance from TSPs regarding line reactor switching and line opening for voltage control. In view of that provision of switching of line reactors may be clearly stipulated in the RfP of proposed scheme.</p> <p>21. CEA stated that line reactor switching in RE pockets is in general operational requirement and need not to be specific for one scheme and should be carried out in real time as per Grid requirement. CTU stated that presently as per IEC standard followed for breaker duty cycle, class M2 circuit breakers i.e frequently operated CBs for special service requirements and designed so as to require only limited maintenance, mechanical type tested for 10,000 operations, however whenever such line reactor switching issue raised by TSP in future, it should come with proper reasoning &amp; justification from TSP side.</p> <p>22. Grid-India stated that in steady state study file, STATCOMs along with MSC/MSR may be kept off for worst scenario (reserved for dynamic range). To mitigate low voltage issues</p>

S. No.	Items	Details
		<p>without STATCOM support, line reactors to be switched off as per requirement.</p> <p>23. CTU stated that in base case voltage at Siwani S/s is about 733kV and in N-1 contingency of one ckt of Bikaner-IV-Siwani 2xD/c lines, voltage may further reduce to 728kV. In above scenario, voltage will be improved to 740kV considering STATCOM (at Bikaner-IV and Siwani) and 748kV with STATCOM+MSC at Bikaner-IV &amp; Siwani S/s. However, in case STATCOM along with MSCs is kept off as suggested by Grid-India and line reactor switching is carried out, it will further improve the voltage of Siwani S/s by 750kV (line reactors on other 3 ckts of 765kV Bikaner-IV-Siwani kept off). In view of that it is recommended that steady state voltage to be maintained over 750kV in planning files considering line reactor switching (760kV at Siwani S/s in present case with line reactor on 765kV Bikaner-IV -Siwani kept off) . Accordingly, it was decided by CEA, CTU &amp; Grid-India that line reactor switching may be carried out in a sequential manner in RE pockets for better voltage control.</p> <p>24. CTU stated that in Feb solar maximized scenario, loading of 400kV RAPP- Shujalpur D/c line is critical (about 950MW) in N-1 contingency. To relieve loading of above line, EHVAC corridor from RAPP generating station or other transmission corridor in parallel to above line to be planned. In 500GW report also, 765kV Ajmer-Kota-Shujalpur transmission corridor was planned to integrate RE complexes of Ajmer. In view of that, it was decided that loading of above line will be reviewed with progress of RE generation projects at Rajasthan and planning to be carried out in next phase to relieve loading on above line. Grid-India &amp; CEA agreed for the same</p> <p>25. Grid-India enquired that timeline for implementation of two nos. of Bikaner-IV-Siwani D/c lines will be same or different. CEA stated that scheme will be segregated in various packages and efforts to be made that all the packages are implemented simultaneously with implementation timeline decided in NCT meeting. Grid-India stated that as per past experiences, there will be always some mismatch (up to 6 months) in implementation time of two parallel double ckt corridors from same RE pooling stations. In such situation, in the event of only one corridor i.e. 765kV Bikaner-IV-Siwani D/c is commissioned and 2nd 765kV D/c gets delayed, RE generation of 2-3GW may only be evacuated in base case with one D/c and in N-1 contingency, however in N-1-1 contingency, restoration of line becomes delayed in solar peak hours and shall impact the RE generation.</p> <p>26. CTU stated that considering HVPNL existing &amp; proposed interconnections, interconnections as well as GNA granted to bulk consumer for 100MW GNA at 220kV Jind(PG), 400/220kV ICTs (3x500 MVA) at Jind(PG) are critically loaded in N-1 contingency. Grid-India stated that at present 400/220kV Jind(PG) S/s has 2x500MVA ICTs &amp; 4 nos. of 220kV interconnections whereas 3<sup>rd</sup> ICT (500MVA) in ISTS by POWERGRID and 4 nos. of STU feeders are under implementation by HVPN. At present loading on 2x500MVA</p>

S. No.	Items	Details
		<p>ICT is about 500MW (peak) and in view of that ICT augmentation at Jind may considered at later stage with commissioning of HVPNL interconnections &amp; 400/220kV ICT (3<sup>rd</sup>) at Jind(PG). HVPNL stated that 400kV Munakh S/s for power evacuation of YTPP (800MW) is under planning. Additionally, 640MVA load will be envisaged progressively from 2027 by IOCL. Accordingly, requirements will be assessed based on Grid-India operational feedback report and loading diversion in planning studies considering HVPNL proposal for evacuation of power from YTPP generation (800MW). CEA agreed for the same</p> <p>27. Off peak file were circulated on 13.01.24 to all stakeholders. Result of system studies incorporating observations received from stakeholders is enclosed in <b>Exhibit-1</b>.</p> <p>28. Considering grant of connectivity to RE generators in Bikaner complex as well as for evacuation of power beyond above complex, transmission scheme (as per S.No.2) was agreed in Joint study meetings (28.12.23 &amp; 09.01.24) as well as in 27<sup>th</sup> CMETS-NR meeting held on 10.01.24 for evacuation of power from Bikaner Complex as part of Rajasthan REZ Ph-IV (Part-3 : 6 GW)</p>
6.	<b>Estimated Cost</b>	<b>Rs. 11400 Cr. (Rs 1.9 Cr./MW)</b>
7.	<b>Need of phasing, if any</b>	Not Applicable
8.	<b>Implementation timeframe</b>	24 months from allocation of project
9.	<b>System Study for evolution of the proposal</b>	<p>Studies discussed and agreed in following meeting</p> <ul style="list-style-type: none"> <li>• Joint study meeting (s) held on 28.12.23 and 09.01.24 (Minutes of meeting attached in <b>Annexure-I</b>)</li> <li>• 27<sup>th</sup> CMETS-NR meeting held on 10.01.24 (Minutes of meeting awaited)</li> </ul> <p>Load flow results is attached at <b>Exhibit-II</b></p>

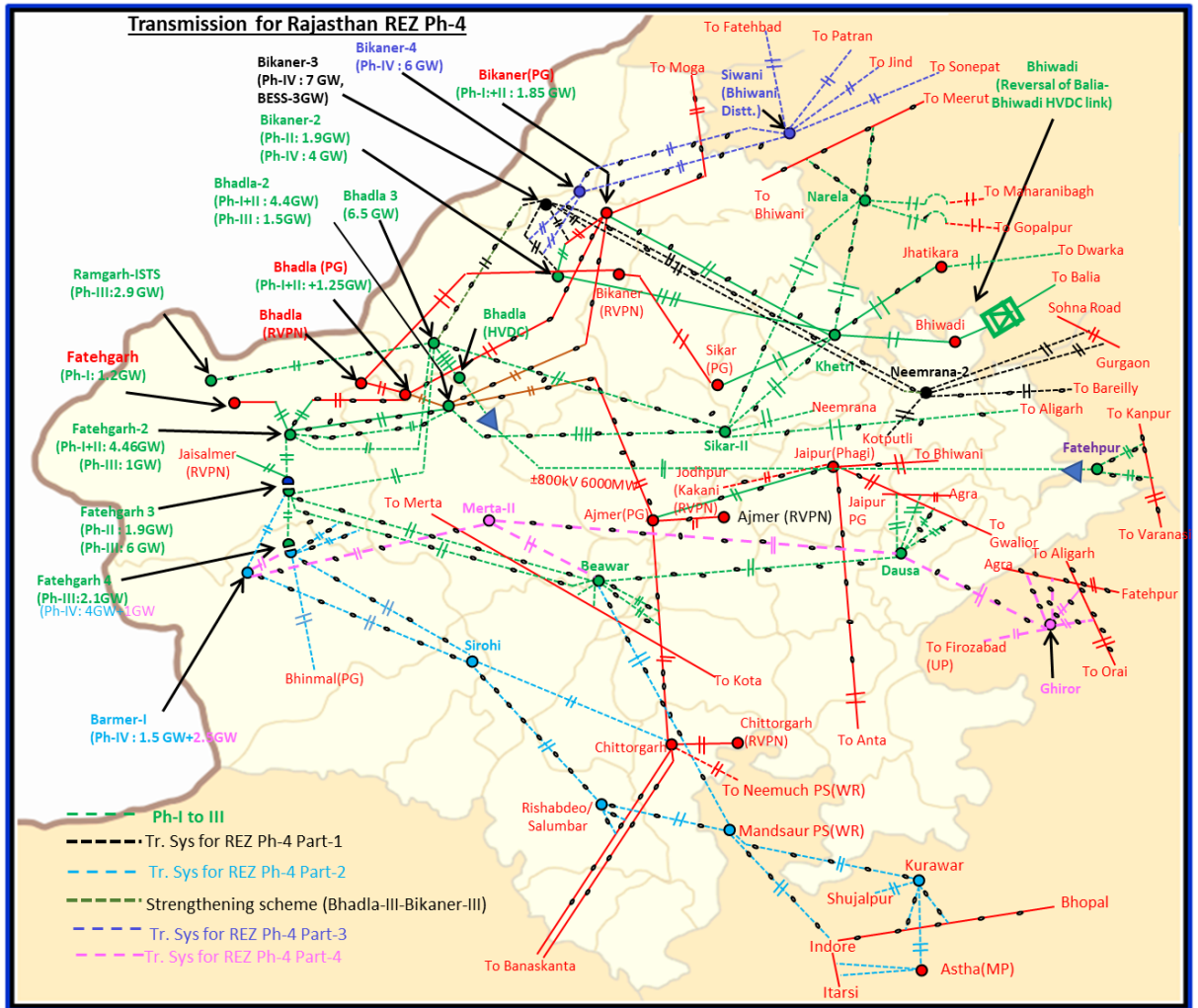

**Fig : Transmission system for evacuation of power from Rajasthan REZ Ph-IV (Part-3 :6 GW) (Bikaner Complex)**



**Transmission system for evacuation of power from Fatehgarh/Barmer Complex as part of Rajasthan REZ Ph-IV (Part-4 :3.5GW) [Fatehgarh/Barmer Complex]**

S. No.	Items	Details
1.	Name of Scheme	Transmission system for evacuation of power from Fatehgarh/Barmer Complex as part of Rajasthan REZ Ph-IV (Part-4 :3.5GW)
2.	Scope of the scheme	<p><b>Transmission system for evacuation of power from Rajasthan REZ Ph-IV (Part-4 :3.5 GW) [Fatehgarh/Barmer] Complex</b></p> <p><b>Fatehgarh-IV: 1 GW (Solar), Barmer-I :2.5GW (Solar)</b></p> <p>➤ Establishment of 765/400kV, 2x1500 MVA S/s at suitable location near Merta (Merta-II Substation) along with 2x125 MVA &amp; 2x240 MVA bus reactor at Merta-II* S/s</p> <p><b>Future provisions at Merta-II S/s(excl. scope for present scheme): Space for</b></p> <ul style="list-style-type: none"> <li>• 765/400kV ICTs along with bays- 4</li> <li>• 765 kV line bays along with switchable line reactors – 8</li> <li>• 765kV Bus Reactor along with bay: 1 nos.</li> <li>• 400 kV line bays along with switchable line reactor –8</li> <li>• 400 kV line bays – 2 nos.</li> <li>• 400 kV Bus Reactor along with bays: 1 no.</li> <li>• 400kV Sectionalizer bay: 2 sets</li> <li>• 400/220kV ICT along with bays -6 nos.</li> <li>• 220 kV line bays for RE injection -8 nos.</li> <li>• 220kV Sectionalizer bay: 2 set</li> <li>• 220 kV BC (3 nos.) bays and 220 kV TBC (3 nos.) bays</li> <li>• 6000 MW, ±800 kV Merta (HVDC) [LCC] terminal station (4x1500 MW) along with bays</li> <li>• STATCOM (2x±300MVA, 4x125MVA MSC, 2x125MVA MSR) along with 400kV bays (2 nos.)</li> </ul> <p><i>*along with provision of 80-MVA &amp; 110MVA spare reactors (Single phase) &amp; 500MVA spare transformer unit (Single phase)</i></p> <p>➤ STATCOM (2x±300MVA) along with MSC (4x125 MVA) &amp; MSR (2x125 MVA) along with 2 nos. 400kV bays at Barmer-I PS</p> <p>➤ Augmentation with 765/400 kV, 2x1500 MVA Transformer (4th &amp; 5th) at Barmer-I PS</p> <p>➤ Augmentation of 5x500 MVA (5<sup>th</sup> to 9<sup>th</sup>), 400/220 kV ICTs at Barmer-I PS</p> <p>➤ 220kV line bays (6 nos.) for RE connectivity at Barmer-I PS</p> <p>➤ 220kV Sectionalizer bay (1 set) along with 220 kV BC (1 nos.) bay and 220 kV TBC (1 nos.) bay at Barmer-I PS</p> <p>➤ 400kV Sectionalizer bay (1 set) at Barmer-I S/s</p> <p>➤ Fatehgarh-IV PS (Sec-2) – Barmer-I PS 400kV D/c line (Quad) (~25km)</p> <p>➤ Barmer-I PS – Merta-II 765 kV D/c line along with 240 MVA switchable line reactor at Barmer-I PS end and 330MVA switchable line reactor at Merta-II PS end for each circuit of Barmer-I PS – Merta-II 765 kV D/c line (~320 km)</p>

S. No.	Items	Details
		<p>➤ Merta-II – Beawar 400 kV D/c line (Quad) (~55 km)</p> <p>➤ Merta-II – Dausa 765 kV D/c line along with 240 MVar switchable line reactor for each circuit at each end of Merta-II – Dausa 765 kV D/c line (~250 km)</p> <p>➤ Establishment of 765/400kV, 2x1500 MVA S/s at suitable location near Ghiror (Distt. Mainpuri) along with 2x125 MVar &amp; 2x240 MVar bus reactor at Ghiror S/s (UP)</p> <p><b>Future provisions at Ghiror S/s** (excl. scope for present scheme): Space for</b></p> <ul style="list-style-type: none"> <li>• 765/400kV ICTs along with bays- 4</li> <li>• 765 kV line bays along with switchable line reactors – 6</li> <li>• 765kV Bus Reactor along with bay: 1 nos.</li> <li>• 400 kV line bays along with switchable line reactor –6</li> <li>• 400 kV Bus Reactor along with bays: 1 no.</li> <li>• 400kV Sectionalizer bay: 1 set</li> <li>• 400/220kV ICT along with bays -4 nos.</li> <li>• 220 kV line bays for drawl -6 nos.</li> <li>• 220kV Sectionalizer bay: 1 set</li> <li>• 220 kV BC (2 nos.) bay and 220 kV TBC (2 nos.) bay</li> <li>• STATCOM (2x±300MVar, 4x125MVar MSC, 2x125MVar MSR) along with 400kV bays (2 nos.)</li> </ul> <p><i>*along with provision of 80MVar spare reactor (Single phase) &amp; 500MVA spare transformer unit (Single phase)</i></p> <p><i>**Drawl requirement at Ghiror S/s to be confirmed by UPPTCL, accordingly future scope will be finalized</i></p> <p>➤ Dausa - Ghiror 765 kV D/c line along with 240 MVar switchable line reactor for each circuit at each end of Dausa - Ghiror 765 kV D/c line (~285 km)</p> <p>➤ LILO of both ckt of 765 kV Aligarh (PG) -Orai (PG) D/c line (~40 km) at Ghiror S/s along with 240 MVar switchable line reactor for each circuit at Ghiror S/s end of 765 kV Ghiror -Orai D/c line</p> <p>➤ LILO of one ckt of 765kV Agra (PG) – Fatehpur(PG) 765kV D/c line at Ghiror along with 240 MVar switchable line reactor at Ghiror S/s end of 765 kV Ghiror -Fatehpur line (~40 kms)</p> <p>➤ 400kV Ghiror-Firozabad (UPPTCL) D/c line (Quad) (~40 kms)</p>
3.	<p><b>Depiction of the scheme on Transmission Grid Map</b></p>	<p>Attached at <b>Exhibit-I</b></p>
4.	<p><b>Upstream/downstream system associated with the scheme</b></p>	<p>765/400/220kV Fatehgarh-IV PS (Sec-2) and Barmer-I PS are under bidding as part of Rajasthan REZ Ph-IV (Part-2 :5.5GW) scheme. 765/400/220kV Fatehgarh-IV PS(Sec-2) is being interconnected to Sirohi S/s (Under bidding), Beawar S/s (Under implementation) and Fatehgarh-III PS (Sec-2) (Under Implementation) at 765kV level and Bhinmal(PG) at 400kV level.</p> <p>765/400/220kV Barmer-I PS is being interconnected to Sirohi S/s (Under bidding) at 765kV level and Fatehgarh-III PS (Sec-2) at 400kV level.</p> <p>765/400KV Dausa S/s is under implementation as part of Rajasthan REZ Ph-III (20 GW) by Beawar-Dausa Transmission</p>

S. No.	Items	Details								
		<p>Ltd. (POWERGRID) is being interconnected to Beawar S/s, Gwalior(PG), Jaipur(RVPN) through 765kV lines and Agra(PG) &amp; Jaipur(South) through 400kV lines</p> <p>765/400kV Aligarh (PG), Orai (PG), Agra (PG) &amp; Fatehpur (PG) are existing ISTS substation of POWERGRID.765kV Orai(PG) S/s is interconnected with Aligarh, Jabalapur, Satna &amp; Gwalior S/s at 765kV level and Orai (UPPTCL) at 400kv level. 765kV Aligarh S/s is interconnected with Orai (PG), Agra(PG), Gr. Noida(UP), Kanpur(PG), Jhatikara(PG) at 765kV level and Prithala (GPTL) at 400kV level.</p> <p>765/400/220kV Fatehpur(PG) is interconnected with Agra(PG), Varanasi (PG) at 765kV level and Allahabad (PG), Kanpur(PG), Mainpuri(PG), Singraulli(NTPC), Unchahar (NBPPL) at 400kV level</p> <p>765/400/220kV Agra(PG) is interconnected with Fatehpur(PG), Jhatikara (PG), Aligarh at 765kV level and Agra (UP), Agra(Fatehbad-UP), Ballabgarh (PG), Bhiwadi (PG), Bassi(PG), Jaipur (South), Sikar(PG), Auraiya (NTPC), Kanpur (PG) at 400kV level. Agra (PG) is interconnected with Biswanath Charialli/Alipurduar through HVDC(±800kV) lines</p>								
5.	<b>Objective / Justification</b>	<p>1.The present scheme comprises Transmission system for evacuation of power from Rajasthan REZ Ph-IV (Part-4 :3.5GW) from Fatehgarh/Barmer complex (Fatehgarh-IV: 1 GW, Barmer-I PS: 2.5GW)</p> <p>2. Joint Study Meeting(s) were held in virtual mode on 28.12.23 and 09.01.24 with SECI, CEA, GRID-INDIA, RVPN, HVPN, PSTCL, UPPTCL and other STUs of Northern region to deliberate &amp; finalize the Transmission system for evacuation of power from Fatehgarh/Barmer Complex as part of Rajasthan REZ Ph-IV (Part-4:3.5GW) scheme.</p> <p><b>Gist of discussion in 1<sup>st</sup> Joint study meeting held on 28.12.23</b></p> <p>3. It was informed that Transmission scheme for Rajasthan REZ Ph-IV (Part-2:5.5GW) (Jaisalmer/Barmer Complex) was approved in 14th NCT meeting for injection at Fatehgarh-IV PS (4GW) &amp; Barmer-I PS (1.5GW) in Rajasthan and under bidding.</p> <p>4. At present connectivity of about 9 GW is already granted/received at Fatehgarh-IV(5GW) and Barmer-I PS(4GW). Studies were carried out in 2026-27 time frame in solar maximized scenario for EHVAC system and Study files for solar maximized scenario was shared on 20.12.23 with all constituents.</p> <p>5. It was stated in meeting that the Evacuation system comprises 3.5 GW capacity EHVAC system from Fatehgarh-IV/Barmer-I (thus makes total planned capacity of 9GW (5.5GW+3.5GW)). Details of RE potential considered in Fatehgarh/Barmer complex is under</p> <table border="1" data-bbox="671 1865 1517 2020"> <thead> <tr> <th data-bbox="671 1865 730 1921">S. No</th> <th data-bbox="730 1865 1070 1921">Transmission Scheme</th> <th data-bbox="1070 1865 1297 1921">RE Potential</th> <th data-bbox="1297 1865 1517 1921">Cumulative Potential</th> </tr> </thead> <tbody> <tr> <td data-bbox="671 1921 730 2020">1</td> <td data-bbox="730 1921 1070 2020">Rajasthan REZ Ph-IV (Part-2:5.5GW) (Jaisalmer/Barmer Complex)</td> <td data-bbox="1070 1921 1297 2020">5.5GW (Solar) Fatehgarh-IV: 4 GW Barmer-I: 1.5 GW</td> <td data-bbox="1297 1921 1517 2020"><b>5.5GW (Solar)</b> Fatehgarh-IV:4 GW Barmer-I: 1.5 GW</td> </tr> </tbody> </table>	S. No	Transmission Scheme	RE Potential	Cumulative Potential	1	Rajasthan REZ Ph-IV (Part-2:5.5GW) (Jaisalmer/Barmer Complex)	5.5GW (Solar) Fatehgarh-IV: 4 GW Barmer-I: 1.5 GW	<b>5.5GW (Solar)</b> Fatehgarh-IV:4 GW Barmer-I: 1.5 GW
S. No	Transmission Scheme	RE Potential	Cumulative Potential							
1	Rajasthan REZ Ph-IV (Part-2:5.5GW) (Jaisalmer/Barmer Complex)	5.5GW (Solar) Fatehgarh-IV: 4 GW Barmer-I: 1.5 GW	<b>5.5GW (Solar)</b> Fatehgarh-IV:4 GW Barmer-I: 1.5 GW							

S. No.	Items	Details		
			EHVAC system -Under Bidding	
2	Rajasthan REZ Ph-IV (Part-4:3.5GW) (Jaisalmer/Barmer Complex) EHVAC system-Present proposal	3.5 GW (Solar)	Fatehgarh-IV: 1 GW Barmer-I: 2.5 GW	<b>9GW (Solar)</b> Fatehgarh-IV: 5 GW Barmer-I: 4 GW
3	Rajasthan REZ Ph-IV (Part-5 : 6GW) (Barmer Complex) HVDC system towards WR/WR-SR	6 GW (Solar)	Barmer-II : 6 GW	<b>15 GW (Solar)</b> Fatehgarh-IV: 5 GW Barmer-I: 4 GW Barmer-II: 6 GW
		<p>6. In the Joint study meeting held on 28.12.2023, following broad transmission system for evacuation of power from Fatehgarh/Barmer Complex as part of Rajasthan REZ Ph-IV (Part-4 :3.5GW) was proposed  <b>Fatehgarh-IV: 1 GW (Solar), Barmer-I :2.5GW (Solar)</b></p> <ul style="list-style-type: none"> <li>➤ Establishment of 765/400kV, 2x1500 MVA S/s at suitable location near Merta (Merta-II Substation)</li> <li>➤ STATCOM (2x+300MVA) along with MSC (4x125 MVA) &amp; MSR (2x125 MVA) at Barmer-I PS</li> <li>➤ Fatehgarh-IV PS – Barmer-I PS 400kV D/c line (Quad)</li> <li>➤ Barmer-I PS – Merta-II 765 kV D/c line</li> <li>➤ Merta-II 765 kV D/c line</li> <li>➤ Merta-II – Beawar 400 kV D/c line (Quad)</li> <li>➤ Merta-II – Dausa 765 kV D/c line</li> <li>➤ Establishment of 765/400kV, 2x1500 MVA S/s at suitable location near Ghiror (Distt. Mainpuri)</li> <li>➤ Dausa - Ghiror 765 kV D/c line</li> <li>➤ LILO of both ckt of 765 kV Aligarh (PG) -Orai (PG) D/c line at Ghiror S/s</li> <li>➤ LILO of one ckt of 765kV Agra (PG) – Fatehpur(PG) 765kV D/c line at Ghiror</li> </ul> <p>7. In above meeting, Grid-India enquired about installation of STATCOMs at new pooling stations in Bikaner and Fatehgarh/Barmer complex. CTU stated that at present 3 nos. STATCOMs are already operational at Fatehgarh-II, Bhadla-II &amp; Bikaner-II and 2 nos. STATCOMs at Ramgarh and Fatehgarh-III are under implementation. Additionally, 3 nos. STATCOMs at Bikaner-IV, Siwani and Barmer-I is also planned in proposed schemes (Ph-IV: Part 3 &amp; 4). Additionally, space provision to be kept STATCOM at Merta-II, &amp; Ghiror S/s as part of future scope.</p> <p>8. Grid-India stated that proposal is in order, however 400/220kV ICTs (2x315MVA) at Agra (PG) is critically loaded in N-1 contingency. CTU stated that with proposed scheme there is marginally increment (~5MW) in 400/220kV ICT loading in Agra. CTU stated that space is not available for installation of 3<sup>rd</sup> ICT at Agra(PG) S/s, therefore replacement of ICTs may be considered in future based on real time loadings.</p> <p>9. CTU stated that in the present proposal, 765kV Aligarh-Orai and Fatehpur -Agra high capacity corridors are optimally utilized as the loadings of lines are lesser in solar maximized scenario. 765/400kV Orai Substation is well connected with WR</p>		

S. No.	Items	Details
		<p>Grid and Power from 765/400kV Orai shall be dispersed to load centres of WR through various high capacity lines. CTU requested UPPTCL to provide space availability for 2 nos. of 400kv line bays at Firozabad S/s for Ghiror-Firozabad D/c line. This will also relieve the loading of Agra ICTs and increase resiliency of system. UPPTCL agreed for the same.</p> <p>10. UPPTCL requested that studies may be performed with Bhadla-Fatehpur HVDC system to check loadings with proposed system. CTU stated that Bhadla-Fatehpur system is under bidding with scheduled implementation Feb'28 (Pole-1) and therefore not considered in studies, however they will carry out sensitivity case considering HVDC system and commensurate RE generation and will provide to UPPTCL. Same was provided to UPPTCL on 02.01.24.</p> <p>11. CEA stated that proposal in order however, studies may be reviewed with UP intra state transmission system and associated RE generation in GEC-II. CTU agreed for the same. CTU enquired SECI and UPPTCL for envisaged RE potential in Bundelkhand region. UPPTCL stated that UPNEDA communicated 10GW RE potential in Bundelkhand region (UP). It was requested that UPPTCL may provide communication to CEA/CTU in 2-3 days, so same can be forwarded to SECI for evaluation of developable RE potential in this region. UPPTCL agreed for the same</p> <p>12. Further, UPPTCL informed in the meeting that space is available for 2 nos. of 400kV line bays at Firozabad S/s however, they shall confirm the same after verification. Prima facie loading of 400kV Ghiror- Firozabad D/c line is in order.</p> <p>13. Revised study files with proposed changes (considering 400kV Ghiror- Firozabad D/c line &amp; Barmer-I STATCOM as part of proposed scheme) and considering UP intra state solar generation and associated transmission scheme (GEC-II) was circulated on 01.05.24 along with study plots.</p> <p><b>Gist of discussion in Joint study meeting held on 09.01.24</b></p> <p>14. CTU stated that in Joint study meeting held on 28.12.23, Transmission system for evacuation of power from Fatehgarh/Barmer Complex as part of Rajasthan REZ Ph-IV (Part-4 :3.5GW) was in-principally agreed. Further, some observations were received on 04.01.24 from Grid-India on studies.</p> <p>15. Grid-India stated that the surplus power in NR and WR during solar peak period is flowing towards ER and high loading is observed in 765 kV Ranchi - Dharamjaygarh line and other EHV lines towards ER with higher angular separation after N-1. Due to high loading, low voltages observed in ER region on various EHVAC buses.</p> <p>16. CTU stated that based on Grid-India observations, in revised studies, Guzuwaka HVDC is already reversed (1000MW) towards ER and Talchar-Kolar capacity is also kept minimum in forward direction (600-700MW). This will relieve loading of various WR-ER corridors incl. 765kV Ranchi – Dharamjaygarh D/c up to a certain extent..</p>

S. No.	Items	Details
		<p>17. CTU stated the loading of some of WR-ER corridors are in general high and with proposed scheme (Rajasthan Ph-IV (Part-4 :3.5 GW)), there is marginal increment on above Inter regional links in winter solar maximized scenario. In the next phase of studies (2028-29) with proposed HVDC corridors from NR to ER and NR to WR, loadings will be reviewed, and measures will be taken up if required. Grid-India &amp; CEA agreed for the same</p> <p>18. CTU enquired about RE potential at Ghiror complex for provision of 220kV scope at Ghiror S/s. SECI replied that solar irradiation level at Ghiror complex is less and at present they are not anticipating RE applications for injection at Ghiror. In view of that it was decided that 220kV future scope shall not be considered at Ghiror for RE injection.</p> <p>19. UPPTCL informed that space is available at 400kV Firozabad S/s for interconnection of proposed 400kV Ghiror – Firozabad D/c line and power flow is in order on the above line. CTU requested UPPTCL to provide the above information in the mail at the earliest. Regarding RE potential in Bundelkhand region, UPPTCL stated that they have received inputs from UPNEDA however UPPTCL sought some clarifications as well as some additional inputs from UPNEDA. CTU requested UPPTCL to provide the same at the earliest.</p> <p>20. Further CTU enquired for drawl requirement at Merta-II and Ghiror S/s. UPPTCL stated that in view of growing load of UP, space provision may be kept for future drawl requirement at Ghiror S/s, however they will confirm the same on mail. RVPN stated that they will revert with the drawl requirement at Mera-II S/s. No other comments received from any Stakeholders. Revised study files incorporating stakeholder comments on all India LGB, study files were already circulated on 06.05.24 along with study plots.</p> <p>21. Off peak file were circulated on 13.01.24 to all stakeholders and based on voltages specially in Ghiror complex, reactive compensation was reviewed &amp; incorporated. Result of system studies incorporating observations received from stakeholders is enclosed in <b>Exhibit-1</b></p> <p>22. Further the proposal was deliberated in 27<sup>th</sup> CMETS-NR meeting held on 10.01,24. In the meeting RVPN stated that they do not have any drawl requirement in future from proposed Merta-2 S/s, however as informed earlier in joint study meeting, in view of envisaged RE potential in Nagaur distt., space provision to be kept for 220kV scope i.e. 400/220kV ICTs., 220 kV line bays for drawl &amp; 220kV Sectionalization bay for RE injection.</p> <p>23. Considering grant of connectivity to RE generators in Fatehgarh/Barmer complex as well as for evacuation of power beyond above complex, transmission scheme (as per S.No.2) was agreed in Joint study meetings (28.12.23 &amp; 09.01.24) as well as in 27<sup>th</sup> CMETS-NR meeting held on 10.01.24 for evacuation of power from Fatehgarh/Barmer Complex as part of Rajasthan REZ Ph-IV (Part-4 :3.5GW)</p>



-----X-----





भारत सरकार

**Government of India**

विद्युत मंत्रालय

**Ministry of Power**

केन्द्रीय विद्युत प्राधिकरण

**Central Electricity Authority**

विद्युत प्रणाली योजना एवं मूल्यांकन-I प्रभाग

**Power System Planning & Appraisal-I Division**

सेवा में / To,

1. Chief Engineer, PSETD Division, CEA, Sewa Bhawan, R.K Puram-I, New Delhi-110066
2. COO (CTUIL), Saudamini, Plot no. 2, Sector -29, Gurgaon-122001
3. Director (Projects), POWERGRID, Saudamini, Plot no. 2, Sector -29, Gurgaon-122001
4. Director (System Operations), NRLDC, Grid-India, Qutab Institutional Area, Katwaria Sarai, New Delhi -110016
5. Chief Engineer (JKPTCL), Kashmir, PDD Complex, Srinagar – 190010
6. Member Secretary (NRPC), Shaheed Jeet Singh Marg, Katwarai Sari, New Delhi-110016.

**विषय / Subject: Minutes of Meeting to deliberate the issue of Charging of 220 kV Wagoora- Zainakote Transmission line**

Madam/Sir,

Please find enclosed minutes of meeting held on 4.10.2023 under the chairmanship of Chief Engineer (PSPA-I), CEA, on the above mentioned subject.

Yours faithfully,

(मंजरी चतुर्वेदी / Manjari Chaturvedi)  
निदेशक / Director

I/30737/2023

**Minutes of Meeting to deliberate the issue of Charging of 220 kV Wagoora- Zainakote Transmission line after re-conductoring**

---

List of participants is enclosed at **Annexure-I**.

**Background:**

JKPTCL vide their letter dated 27.09.2023 (copy enclosed) has informed that reconductoring of one circuit of 220 kV Wagoora- Zainakote D/c transmission line (Zebra configuration) with HTLS conductor was proposed with conductor of current carrying capacity of 1600 Amp. Administrative approval for the same was accorded by Principal Secretary, Govt. of J&K on 02.08.2021.

Further, JKPTCL has also informed that presently there is a T-off feeding power at Budgam and in the first phase, replacement of existing Zebra conductor by HTLS conductor has been completed up to T point (18 km) and after charging this portion of line, from Wagoora end, replacement of conductor from T-point to Zainakote (around 10 kms) shall be taken up which is likely to be completed by October 2023.

However, as the proposal of reconductoring of the transmission line with high ampacity conductor had not been deliberated in the Standing Committee on Power System Planning for Northern Region (SCPSNR)/Northern Region Power Committee (Transmission Planning) of CEA, therefore, NRLDC had requested JKPTCL get the approval of CEA prior to charging of the portion of the line.

**Deliberations held in the meeting**

1. On a query regarding the tapping arrangement of the 220 kV Wagoora- Zainakote Transmission line to Budgam GSS which is not permitted as per CEA Regulations, JKPTCL informed that due to severe RoW issues in that area, LILO of the mentioned transmission line at Budgam GSS was not possible, hence tapping of one circuit had been done to supply power to Budgam.
2. Chief Engineer (PSE&TD), CEA, stated that as per clause 46 (4) of Central Electricity Authority (Measures relating to Safety and Electric Supply) Regulations, 2023, tapping is not allowed in 66 kV and above transmission lines. Relevant para of the Regulation is reproduced below:

*46(4) There shall not be tapping of another transmission line from the main line for 66 kV and above class of lines:*

*Provided that during natural calamities, tapping may be allowed to ensure emergency power supply to affected areas till normalcy is restored.*
3. Chief Engineer, JKPTCL, informed that another 220 kV D/c transmission line is presently under construction from Wagoora to Zainakote with LILO at Budgam for supply of power to Budgam. The construction of line including LILO portion is expected to be completed by March, 2024. Thereafter, the tapping of existing circuit to Budgam would be removed.

I/30737/2023

4. Regarding the equipment rating of bays at Wagoora end, CTUIL expressed concern that the timeframe of the bay upgradation works at both Wagoora and Zainakote end should match with the completion schedule of reconductoring of the transmission line, as the loading of the transmission line significantly increases in the winter season. In this regard, POWERGRID informed that bay upgradation works at Wagoora is underway and the same is likely to be completed by March, 2024. Accordingly, POWERGRID was requested to expedite the works at Wagoora S/s.
5. NRLDC also highlighted the issue of frequent tripping of the 220 kV Wagoora- Zainakote transmission line due to overloading issue. In this regard, JKPTCL stated that reconductoring with HTLS conductor would certainly help in mitigating this issue. Further, JKPTCL informed that the jumpers at tapping point towards Zainakote would be opened for carrying out the reconductoring works of the remaining part of the transmission line, i.e from T point to Zainakote end. Therefore, till the completion of the reconductoring works of the circuit, JKPTCL has requested to charge the Budgam S/s from Wagoora end, in order to restore supply in the Budgam area. After completion of the reconductoring from T point to Zainakote, the jumpers would again be connected.
6. POWERGRID further requested JKPTCL to maintain the 220 kV Wagoora- Zainakote line in healthy condition as tripping of this line leads to tripping of Srinagar-Leh 220 kV transmission line.
7. NRPC would be informed about the matter so that the same may be deliberated and monitored in the NRPC/OCC forum.
8. After deliberations, following was decided:
  - i. The reconductoring of 220 kV Wagoora- Zainakote line with high ampacity conductor was noted.
  - ii. JKPTCL was requested to complete the 2<sup>nd</sup> D/c line between Wagoora- Zainakote with LILO at Budgam, at the earliest and subsequently remove the tapping of existing circuit at Budgam at the earliest.
  - iii. JKPTCL to take the necessary measures including protection settings to maintain the healthiness of the 220 kV Wagoora- Zainakote transmission line.
  - iv. NRPC to be apprised about the issue, so that the same could be deliberated in NRPC/OCC forum so as to ensure that the tapping is removed at the earliest.

## Annexure-I

## List of Participants

S.No.	Name (Smt/Shri)	Designation
<b>I</b>	<b>CEA</b>	
1.	Ramesh Kumar	Chief Engineer, PSETD
2.	Ishan Sharan	Chief Engineer, PSPA-I
3.	Manjari Charturvedi	Director
4.	Nitin Deswal	Deputy Director
5.	Komal Dupare	Assistant Director
<b>II</b>	<b>POWERGRID</b>	
6.	Abhay Kumar Choudhary	Chief General Manager
<b>III</b>	<b>GRID INDIA</b>	
7.	Alok Kumar Verma	General Manager
8.	Gaurav Malviya	Deputy Manager
<b>IV</b>	<b>JKPTCL</b>	
9.	Javed Yusuf	Chief Engineer
<b>V</b>	<b>CTUIL</b>	
10.	Madhusudan Meena	Engineer

## उत्तर प्रदेश राज्य भार प्रेषण केन्द्र

उपग्रहवीवर ट्रांसमिशन कॉरपोरेशन लि०

(उत्तर प्रदेश सरकार का उपक्रम)

यूपीएलसीएलसीडीसी परिषद, विभूति खण्ड-II

गोमती नगर, लखनऊ-226010

ई-मेल: cepso@upslde.org

sera@upslde.org



## U.P. State Load Despatch Centre

U.P. Power Transmission Corporation Ltd.

(A U.P. Govt. Undertaking)

UPSLDC Complex, Vibhuti Khand – II

Gomti Nagar, Lucknow- 226010

E-mail: cepso@upslde.org

sera@upslde.org

No: 4363 /Dir(SLDC)/CE(PSO)/SE(R&amp;A)/EE-II/Agra Islanding

Dated: - 23-12-2023

✓ Director (Operation), UPPTCL, 11 <sup>th</sup> Floor, Shakti Bhawan Extn., Lucknow.	M/s LPGCL, TC-13, Vibhuti Khand, Gomti Nagar, Lucknow 226010 (serlpgcl.ltp@lpgcl.com)	M/s CPRI, Bengaluru, Karnataka
--	--	-----------------------------------

**Subject: - Record proceedings of meeting to discuss issue raised by M/s LPGCL on study report of Agra islanding Scheme submitted by CPRI.**

In view of the concern raised by M/s LPGCL on subject issue in 48<sup>th</sup> TCC /70<sup>th</sup> NRPC meeting and special meeting held on 30.11.2023 in UPSLDC, a meeting on subject issue was held on 19.12.2023 in the office of Managing Director, UPPTCL. Copy of the record proceedings of the meeting is enclosed for kind information.

**Encl: - Record proceedings of the meeting**

**Observation of M/s LPGCL on study report (Annex.-I)**

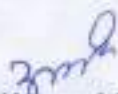
  
 (Arun Kumar Mishra)  
**Director, UPSLDC**

No: - /Dir(SLDC)/CE(PSO)/SE(R&A)/EE-II/Agra Islanding

Dated: -

2023

Copy forwarded to following for kind information:-

1. PS to MD, UPPTCL, 7th Floor, Shakti Bhawan, Lucknow.
2. Chief Engineer (PSO), UPSLDC, Vibhuti Khand – II, Gomti Nagar, Lucknow.
3. General Manager, NRLDC, 18-A, SJSS Marg, Katwaria Sarai, New Delhi – 110016.
4. SE (Operations), NRPC, 18 – A SJSS Marg, Katwaria Sarai, New Delhi, 110016.

  
 (Arun Kumar Mishra)  
**Director, UPSLDC**

**Record proceedings of the meeting regarding M/s LPGCL observation on Agra islanding scheme study report by CPRI held on 19.12.2023 in office of MD UPPTCL**

**Date of meeting-19.12.2023**

**Venue of meeting- Office of Managing Director, UPPTCL**

**List of the participants**

1. Shri P.Guruprasad, IAS, MD, UPPTCL.
2. Shri Arun Kumar Mishra, Director, UPSLDC.
3. Er. A.J. Siddiqui, Chief Engineer, (PSO), UPSLDC.
4. Er. Ram Sharan Singh, Executive Engineer, (R&A), UPSLDC.
5. Er. Mohsin Khan, Assistant Engineer – I (R&A), UPSLDC.
6. Shri R.N Bedi, President, LPGCL.

**1. Decision in Case no-11 & 12 (as per Annx.-I) regarding Under Frequency issue**

As per the report submitted by CPRI in cases nos. 11 and 12 although frequency is going below 47.5Hz after islanding, but it remains below 47.5Hz for not more than 2 sec. As per class C protection the delay of under frequency tripping (at 47.5Hz) is 3 second. Therefore operating Islanding frequency is not breaching frequency setting provided by OEM. It is also worth mentioning that in the above two cases the deficit in generation has been taken care by Under Frequency Load Shedding (UFLS) Scheme. In case of any delay/mal-operation in switching operations, Island may not survive. However, if all the switching operations are executed timely, scheme will be successful.

**2. Decision in Case no- 4,5,7 and 8 (as per Annx.-I) regarding Over Frequency issue**

As per settings provided by M/s LPGCL over frequency setting for turbine tripping is as follows:-

- a)  $f > 51.5\text{Hz}$ , delay of 30Sec
- b) At 3300RPM (55 Hz) - Instantaneous tripping

As per the report submitted by CPRI in cases nos., 4, 5, 7 & 8, frequency is reaching above 51.5Hz but it comes down within 30 second and therefore it is not violating the settings provided by OEM. As per the report submitted by CPRI, the instantaneous tripping for over frequency is at 52.5 Hz. However, as per OEM recommendation, the same is at 55 Hz (3300 RPM). Representative from LPGCL requested that the same may be corrected by CPRI in their report.

Also, in case of any delay/mal-operation in switching operations, Island may not survive. However, if all the switching operations are executed timely, scheme will be successful.

**3. Decision in Case no - 3,4,7,15 &18 (as per Annx.-I) regarding abrupt change in generation after Islanding**

Representative from LPGCL informed that in above cases generation of units are changing abruptly post Islanding which may not be possible due to slow response of boiler. As per information provided by representative from M/s CPRI in simulation studies boiler dynamics has not been considered. Further LPGCL informed that in aforementioned scenario, the load generation gap cannot be balanced due to slow response of Boiler (8 minutes) in producing steam required to meet the balance load requirement. **This may result in under frequency tripping of Generators and hence may not contribute to successful Islanding.**

Based on above discussion it was decided that the final report of Agra Islanding Scheme submitted by M/s CPRI shall be put up in next NRPC meeting for approval and implementation.

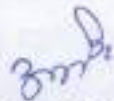
  
(Arun Kumar Mishra)  
**Director, UPSLDC**

**CASE WISE OBSERVATIONS BY LALITPUR TPS IN THE MEETING HELD ON 30.11.2023**

Three different loading conditions- peak summer load (1337 MW), off peak winter load (870 MW) and typical average loads (950MW) have been considered in the simulation study. For each operating condition, initial Ex bus generation of each generator of Lalitpur plant is considered as - 330 MW (technical minimum of the generator), 610 MW (highest generation), and 460 MW (average generation). Also, the number of generators connected to the grid before islanding can be two or three. Therefore, a total of 18 test cases are considered and post islanding frequency stability of the island has been studied by CPRI & curves are presented. Based on these cases and curves, LPGCL has following observations:

**Islanding has been considered at 47.9Hz**

Case No	Conditions taken by CPRI as per UPPTCL requirement	LPGCL observation
Case-3	Initial Generation =990 MW(330X3) (Minimum Generation) Load in the Island = 1337 MW (Peak Load during Summer)	1. Load-Generation gap in island is 337 MW which may result in under frequency tripping of generators. 2. In the simulation study the Boiler response is not considered by CPRI.
Case-4	Initial Generation =1830 MW (610X3) (Peak Generation) Load in the Island = 950 MW (Average Load)	1. During islanding operation frequency is reaching 52 Hz which has not been recommended by OEM 2. Generation is varying from 610MW to 320MW(at the time of Islanding) and from 320MW to 480MW (after one generator trip) within time duration of 2 secs is to be analysed with respect to integrity of Turbine and Generator. This may please be noted that the desired load ramp up/ramp down is 1% per minute. Hence this operation is not a healthy operation with respect Turbine and Governor reliability.
Case-5	Initial Generation =1380 MW (460X3)(Average Generation) Load in the Island = 950 MW (Average Load)	As per the report, after initiation of islanding at 47.9 Hz, frequency is reaching 52.2 Hz and also it may go up to 52.5 Hz. This increase in frequency up to 52.2 /52.5 Hz is not allowed as per OEM.
Case-7	Initial Generation =1830 MW(610X3) (Peak Generation) Load in the Island = 870 MW (minimum load during winter)	1. If one generator is not getting tripped at 51.5Hz then frequency is reaching 54Hz, which is very dangerous case, so generator has to be tripped at any cost in a reliable manner. The question of no generator tripping doesn't arise. 2. Generation is varying from 610MW to 320MW(at the time of Islanding) and from 320MW to 440MW (after one generator trip)



		within time duration of 2 secs is to be analysed with respect to integrity of Turbine and Generator. This may please be noted that the desired load ramp up/ramp down is 1% per minute. Hence this operation is not a healthy operation with respect Turbine and Governor reliability.
Case-8	Initial Generation = 460X3=1380 MW (Average Generation) Load in the Island = 870 MW (Minimum Load)	Generator frequency is reaching at 52.4 Hz & same is not allowed. Final stabilization frequency is around 51Hz which is on higher side.
Case-11	Initial Generation =920 MW(460X2) (Average Generation) Load in the Island = 1337 MW (Peak Load)	<p>1. The frequency is allowed to go below 47.5Hz i.e 47.3 Hz which is not allowed as per OEM. Please note that LPGCLs present setting is as under: -  F&lt; 47.5 Hz Class C trip after delay of 3 Seconds.  F&lt; 47.5 Hz Class A Generator Trip after delay of 5 Second. So this setting will not allow this islanding operation. How the uncertainty in the load shedding can be ensured ?</p> <p>2.The biggest issue in this case is that Island load is 417MW more than the generation. After Island the load generation gap cannot be balanced due to slow response of Boiler (8 minutes) in generating required steam to meet the balance load requirement. This may result in under frequency tripping of Generators. In the simulation study the Boiler response is not considered by CPRI.</p> <p>3.In this case also there is load shedding and load reconnection.</p>
Case-12	Initial Generation =660 MW (330X2)(Minimum Generation) Load in the Island = 1337 MW (Peak Load)	<p>1.The frequency is allowed to go below 47.5Hz i.e 47.3Hz which is not allowed as per OEM. Please note that LPGCLs present setting is as under:-  F&lt; 47.5 Hz Class C trip after delay of 3 Second.  F&lt; 47.5 Hz Class A Generator Trip after delay of 5 Second. So this setting will not allow this islanding operation. How the uncertainty in the load shedding can be ensured?</p> <p>2.The biggest issue in this case is that Island load is 667MW more than the generation. After Island the load generation gap cannot be</p>

		balanced due to slow response of Boiler (8 minutes) in generating required steam to meet the balance load requirement. This may result in under frequency tripping of Generators. In the simulation study the Boiler response is not considered by CPRI.
Case-15	Initial Generation =660 MW (330x2)(Low Generation) Load in the Island = 950 MW (Average Load)	The biggest issue in this case is that Island load is 290MW more than the generation. After Island the load generation gap cannot be balanced due to slow response of Boiler (8 minutes) in generating required steam to meet the balance load requirement. This may result in under frequency tripping of Generators. In the simulation study the Boiler response is not considered by CPRI.
Case-18	Initial Generation = 330X2=660 MW (Minimum Generation) Load in the Island = 870 MW (Minimum Load)	The biggest issue in this case is that Island load is 210MW more than the generation. After Island the load generation gap cannot be balanced due to slow response of Boiler (8 minutes) in generating required steam to meet the balance load requirement. This may result in under frequency tripping of Generators. In the simulation study the Boiler response is not considered by CPRI.
SOP to be prepared for Resynchronization with grid after Islanding operation. This is very important for system revival.		

*Amit Narain*

**(Amit Narain)**  
**Superintending Engineer (R&A)**

## A Consultancy Report

On

# POWER SYSTEMS STATIC AND DYNAMIC STABILITY FOR AGRA ISLANDING SCHEME

Client Ref. No.: Work order L. No 2415 ETC (A)/Agra dated 17/7/2022  
CPRI Report No.: 2/9/PSD/RT88/2023

Client: Uttar Pradesh Power Transmission Corporation Ltd (UPPTCL)

Consultant: Central Power Research Institute (CPRI)



POWER SYSTEMS DIVISION  
CENTRAL POWER RESEARCH  
INSTITUTE  
SIR.C.V.RAMANROAD,P.B.NO.8066  
SADASHIVANAGAR P.O  
BENGALURU -560080  
WEBSITE :<http://www.cpri.in>

July 2023



**POWER SYSTEMS DIVISION  
CENTRAL POWER RESEARCH INSTITUTE  
Sir. C.V.RAMAN ROAD P.B.No.8066, BANGALORE 560080 (INDIA)**

**Consultancy Report**

Sheet 1 of 1

Ref. File No.: 2/9/UPPTCL/2023

Date: 06/02/2023

Title:	Power systems static and dynamic stability for Agra islanding scheme.
Project Objectives	To perform the steady state and dynamic power system study of Agra Island for different loading and generation scenario.
Name and Address of the Customer:	M/s Uttar Pradesh Power Transmission Corporation Ltd 11 <sup>th</sup> Floor, Shakti Bhawan Extn. 14- Ashok Marg, Lucknow-226001
CPRI's reference	L.No 2415 ETC (A)/Agra dated 17/7/2022.
Name(s) of investigator(s) from CPRI	1. Dr Manohar Singh, Engineering Officer Grade-4 2. Mr Venkatesh D, Engineering Officer Grade-1
Names of interacting persons from Customer's side:	1. Mr. Pankaj Malviya, Chief Engineer (Operation) 2. Mr Pankaj Saxena, Superintending, Engineer(Operation) 3. Mr. Mosin , Assistant Engineer, SLDC
Report contains:	No of pages: 75

Report prepared by:

Report Approved by:

Signature:

Signature:

Name: Dr Manohar Singh

Name: Dr. Sreedevi J

## Contents

S.No		Page
1.0	Background	1
2.0	Scope Of Work	2
3.0	Overview Of Agra Electrical System	3
4.0	Islanding Scheme – Agra	3
5.0	Modelling of Agra Island	6
6.0	Simulation Tool	6
7.0	Methodology	6
8.0	Steady state Power Flow Analysis	7
8.1	Generation-load Agra	8
8.2	Voltage Profile in Agra Island	8
8.3	Loading Details in Agra Island	10
8.4	Tie line Power Flow	11
8.5	Transformer Loading	11
8.6	Line Loading	12
9.0	Dynamic modelling	13
9.1	Modelling of Generator	13
9.2	Generator Controls	13
9.2.1	Modelling of Exciter	13
9.2.2	Power System Stabilizer (PSS)	14
9.2.3	Turbine Governor Model	15
9.3	Relay Settings	15
9.3.1	Under Frequency Load Shedding (UFLS) Relay Settings	16
9.3.2	Over Frequency Load Reconnection (OFLC) Relay Settings	23
9.3.3	Over Frequency Generator Tripping (OFGT) Relay Settings	23
9.3.4	Low Power Generation Tripping (LPGT)	25
9.4	Validation of Relay Settings Using Simulation	25
9.4.1	Case 1: Peak Load-Three Generators-Peak Initial Generation	25
9.4.2	Case 2: Peak Load-Three Generators - Average Initial Generation	27
9.4.3	Case 3: Peak Load-Three Generators - Minimum Initial Generation	29

9.4.4	Case 4: Average Load-Three Generator-Peak Initial Generation	31
9.4.5	Case 5: Average Load-Three Generators-Average Initial Generation	34
9.4.6	Case 6: Average Load-Three Generators-Minimum Initial Generation	36
9.4.7	Case 7: Minimum Load-Three Generators-Peak Initial Generation	37
9.4.8	Case 8: Minimum Load-Three Generators-Average Initial Generation	40
9.4.9	Case 9: Minimum Load-Three Generators-Minimum Initial Generation	41
9.4.10	Case 10: Peak Load-Two Generators-Peak Initial Generation	43
9.4.11	Case 11: Peak Load-Two Generators- Average Initial Generation	47
9.4.12	Case 12: Peak Load-Two Generators-Minimum Initial Generation	50
9.4.13	Case 13: Average Load-Two Generators-Peak Initial Generation	53
9.4.14	Case 14: Average Load-Two Generators-Average Initial Generation	54
9.4.15	Case 15: Average Load-Two Generators-Minimum Initial Generation	55
9.4.16	Case 16: Minimum Load-Two Generators-Peak Initial Generation	56
9.4.17	Case 17: Minimum Load-Two Generators-Average Initial Generation	57
9.4.18	Case 18: Minimum Load-Two Generators-Minimum Initial Generation	59
9.5	Summary of Simulation Test Cases	60
9.6	Islanding During One Machine Connected to Grid	61
9.6.1	Islanding During One Machine ON, Winter Load, Minimum Initial Generation	61
9.6.2	Islanding During One Machine ON, Summer Load, Winter Load, Minimum Initial Generation	63
10.0	Change in Plant/System Control Settings	65
	<b>List of tables &amp; figures</b>	
Table 8.1.1	The summary of Generation-load Agra for Different studies Cases.	7
Table 8.1.2	Generation Schedule of Generating units Lalitpur TPS	8
Table 8.2	Bus Voltage Profile	8
Table 8.3	Agra Island Load	10
Table 8.4.1	Inter Area Power flow	11
Table 8.4.2	Tie line Power Flow	11
Table 8.5	Transformer loading	11
Table I	GENROU Model of Synchronous Generator	13
Table II	ESAC1A Model of Synchronous Generator Exciter	14

Table III	STAB1 Model of Power System Stabilizer	14
Table IV	IEEEG1 Model of the Turbine-Governor	15
Table V	UFLS Relay Settings and Loads Tripped During Summer	16
Table VI	OFLC Relay Settings and Loads Reconnected During Summer	23
Table VII	foFGT a function of fnadir measured at the generator bus	25
Table VIII	Summary of the simulation Test cases	60
Figure 1.1(a)	Proposed Agra island ( Agra side)	4
Figure 1.1(b)	Proposed Agra island ( Lalitpur side)	5
Figure 1.2(a)	Agra Island after Stage-I load shedding( Agra side)	17
Figure 1.2(b)	Agra Island after Stage-I load shedding( Lalitpur side)	18
Figure 1.3(a)	Agra Island after Stage-II load shedding( Agra side)	19
Figure 1.3(b)	Agra Island after Stage-II load shedding( Lalitpur side)	20
Figure 1.4(a)	Agra Island after Stage-III load shedding( Agra side)	21
Figure 1.4(b)	Agra Island after Stage-III load shedding( Lalitpur side)	22
Figure.1	Variations in frequency, mechanical power and electrical power in case of islanding during peak load, peak initial generation with three generators connected to the grid.	26
Figure.2	Variations in frequency, mechanical power and electrical power in case of islanding during peak load, average initial generation with three generators connected to the grid.	28
Figure.3	Variations in frequency, mechanical power and electrical power in case of islanding during peak load, three generators connected to the grid with minimum initial generation.	30
Figure. 4	Variations in frequency, mechanical power and electrical power in case of islanding during average load, peak initial generation with three generators connected to the grid. A generator is tripped early to avoid tripping of all the generators due to over-speed.	32
Figure. 5	Variations in frequency, mechanical power and electrical power in case of islanding during average load, peak initial generation with three generators connected to the grid. No generator is tripped as part control action to restrict the island frequency.	33
Figure.6	Variations in frequency, mechanical power and electrical power in case of islanding during average load, average initial generation with three generators connected to the grid.	35
Figure.7	Variations in frequency, mechanical power and electrical power in case of islanding during average load, minimum initial generation with three generators connected to the grid.	36
Figure.8	Variations in frequency, mechanical power and electrical power in case of islanding during minimum load, peak initial generation with three generators connected to the grid. A generator is tripped early to avoid tripping of all generators at 52.5 Hz.	38



Figure.9	Variations in frequency, mechanical power and electrical power in case of islanding during minimum load, peak initial generation with three generators connected to the grid. No generator was tripped early by the OFGT relay. All generators will be tripped by the default protection schemes of the plant as the generator speed reaches 52.5 Hz.	39
Figure.10.	Variations in frequency, mechanical power and electrical power in case of islanding during minimum load, average initial generation with three generators connected to the grid.	40
Figure.11.	Part of the frequency response is zoomed to show the variation in slope and trip time in case of islanding during minimum load, average initial generation with three generators connected to the grid.	41
Figure.12	Variations in frequency, mechanical power and electrical power in case of islanding during minimum load, minimum initial generation with three generators connected to the grid.	42
Figure.13	Variations in frequency, mechanical power and electrical power in case of islanding during peak load, peak initial generation with two generators connected to the grid. UFLS and over frequency load reconnection are used to stabilize the frequency in the island.	44
Figure.14	A portion of the electrical power output curve is zoomed to show UFLS and OFLR events.	45
Figure.15	Variations in frequency, mechanical power and electrical power in case of islanding during peak load, peak initial generation with three generators connected to the grid. No over frequency load reconnection is done.	45
Figure.16	Variations in frequency, mechanical power and electrical power in case of islanding during peak load, peak initial generation with two generators connected to the grid. No load shedding was done.	46
Figure.17	Variations in frequency, mechanical power and electrical power in case of islanding during peak load, average initial generation with two generators connected to the grid. UFLS and over frequency load reconnection were done to stabilize the frequency in the island.	48
Figure.18	Variations in frequency, mechanical power and electrical power in case of islanding during peak load, average initial generation with two generators connected to the grid. No load shedding and load reconnection was done.	49
Figure.19	Variations in frequency, mechanical power and electrical power in case of islanding during peak load, minimum initial generation with two generators connected to the grid. UFLS and OFLR were done to stabilize the frequency in the island.	51
Figure.20	Variations in frequency, mechanical power and electrical power in case of islanding during peak load, minimum initial generation with two generators connected to the grid. No load shedding was done.	52
Figure.21	Variations in frequency, mechanical power and electrical power in case of islanding during average load, peak initial generation with two generators connected to the grid.	53
Figure.22	Variations in frequency, mechanical power and electrical power in case of islanding during average load, average initial generation with two generators connected to the grid.	54

Figure.23	Variations in frequency, mechanical power and electrical power in case of islanding during average load, minimum initial generation with two generators connected to the grid.	55
Figure.24	Variations in frequency, mechanical power and electrical power in case of islanding during minimum load, peak initial generation with two generators connected to the grid.	56
Figure.25	Variations in frequency, mechanical power and electrical power in case of islanding during minimum load, average initial generation with two generators connected to the grid.	58
Figure.26	Variations in frequency, mechanical power and electrical power in case of islanding during minimum load, minimum initial generation with two generators connected to the grid.	59
Figure.27	Variations in frequency, mechanical power and electrical power in case of islanding during minimum load, minimum initial generation with one generator connected to the grid.	62
Figure.28	Variations in frequency, mechanical power and electrical power in case of islanding during peak load, minimum initial generation with one generator connected to the grid.	64

## Executive Summary

CPRI received Indian Grid data with bus voltages up to 132kV level. CPRI also received internal network data up to 33kV voltage level, peak summer load and off-peak winter load details. Based on this, we generated three different loading conditions- peak summer load, off-peak winter load and typical average loads. For each operating condition, initial generation of each generator in the Lalitpur plant was considered for three different values- 330 MW (~technical minima of the generator), 610 MW (highest generation), and 460 MW (average generation). Also, the number of generators connected to the grid before islanding can be two or three. Therefore, a total of 18 test cases were generated and post islanding frequency stability of the island was studied using simulation in PSS/E 34.0 software. Based on these case studies, following observations were made:

- When three generators are connected to grid, post islanding frequency always increase. To limit the frequency overshoot beyond 52.5 Hz, one generator may be tripped in some cases. Using the proposed over frequency generator tripping (OFGT) relay, frequency in the island is restricted below 52.5 Hz.
- When three generators are ON, initial generation is low and load in the island is also less, electrical power output of the generators may be less than technical minimum. Hence, a generator should be tripped either automatically or by the operator manually.
- When two generators are connected to the grid and load in the island is high, frequency will fall after islanding. Under Frequency Load Shedding (UFLS) is required to restrict the frequency fall. UFLS is proposed in three stages- at 47.6 Hz, 47.3 Hz and 47.1 Hz. Total amount of load shed in these three stages are sufficient to take care of the generation deficit during peak load and minimum generation with two generators ON.
- As load shedding is done in large steps, it may cause frequency overshoot. To limit the frequency overshoot beyond 52.5 Hz and reduce the difference between generation and load, load reconnection is done in small steps. It has been shown that load reconnection helps in restricting frequency overshoot and minimizing the difference between post islanding and pre-islanding electrical power output which is necessary for a plant with low generate rate limit.
- Change in Plant Control Settings:
  - Under frequency generation tripping below 47.5 Hz: Change the delay to 5 seconds or instantaneous tripping at 46.5 Hz. OEM should be consulted for this.
  - The limit on the frequency deviation in the droop control is 3% i.e., 1.5Hz. Hence the droop control works for frequency range of 48.5-51.5Hz. This is fine for normal operation of generators. However, if the limit is removed or at least increased to -6% to +5% (47Hz - 52.5Hz) it will help in increasing the mechanical power during the frequency fall in islanding operation.
- If there is just one machine ON during the islanding, successful operation of the island is ensured only if the load is less (e.g. winter load). However, if the load is high (e.g. summer load) and only machine is ON, frequency can't be stabilized with the designed relays. Finding a common set of relay settings (especially the UFLS relays) which

ensures successful operation for one machine ON during peak load and three machines ON during peak load is difficult. Considering the fact that one machine operation of the plant generally doesn't happen, especially during summer peak load, this was avoided while designing the relay settings.

- Reactive power should be supplied locally to maintain close to unity power factor in transmission lines. This will prevent any possible voltage instability after islanding during peak load conditions.
- Resynchronization After Islanding: There are standard relays available in the market (e.g. Schweitzer Engineering Laboratories, Inc.) for synchronization of island with rest of the grid. Matching of voltage, frequency and phase angle is ensured by the relay.

## 1.0 Background

The growth of system loading requires utilities to operate close to the maximum capabilities of their transmission systems, increasing the possibility of unstable swings among generators. When severe faults occur in a system, loss of synchronism between groups of generators may take place after single or multiple swings, and if appropriate action is not taken on time, the loss of synchronism may cascade to the rest of the system and cause large blackouts.

There were two such major disturbances, one at 02.33 hrs. on 30-07-2012 and second at 13.00hrs on 31-07-2012 in the Indian Grid. The Committee looking into the detailed causes of these disturbances has recommended that effort should be made by power utilities of states for formation of electrical islands in case of imminent grid disturbance. In this regard, Agra being one of the heritage cities of the country, the importance of maintaining the uninterrupted power supply to essential services is of utmost importance and driving force for having an efficient islanding scheme with the following objectives:

- (i) To isolate Agra's Power System from the regional grid when grid disturbance is imminent
- (ii) After isolation, continue to meet important loads of essential services.
- (iii) To extend start up supply to generating stations in adjoining area to facilitate early restoration.

Under severe system disturbances the islanding scheme in place would result in isolating Agra system from the grid with the generators in island presumed to be remaining in synchronism. However, stability of the island i.e. the island will reach an acceptable state of operating equilibrium needs to be examined as the island formed may be either an over generated island or an under generated island. The turbine-generator over speed controls, under frequency load shedding and the power plant controls - all have an impact on the performance on the stable operation of the system i.e. damping of the power oscillations, peak overshoot or maximum frequency deviation etc. when islands are formed.

Thus, steady state and dynamic simulation study of islanded operation needs to be carried out under various operating scenarios to validate strength and weakness of the proposed islanding Agra islanding scheme. The findings from such simulation will be of great help in identifying additional steps, if any, which need to be taken for enhancing success rate of proposed islanding.

In this context M/s CPRI received a work order L.No 2415 ETC (A)/Agra dated 17/7/2022 from Uttar Pradesh Power Transmission Corporation Ltd, for carrying out "Power systems static and dynamic stability for Agra islanding scheme.

## 2.0 Scope of Work

The “Power Systems Static & Dynamic stability for Agra Islanding Scheme,” will be simulated for two operational scenarios (a) Peak and (b) off-peak loading conditions. UPPTCL will provide the PSS/E. sav (steady state) and PSS/E. dyr (dynamic file) for UPPTCL network. The scope of work for Agra Islanding Scheme will be executed as given below:

1. Review of PSS/E. sav and PSS/E. dyr for its steady state and dynamic response for any disturbance in proposed islands or outside the islands.
2. Equivalent Modelling of grid interfacing connection to match the power flow/ dynamic response with realistic power flow behavior as experience/ provided by UPPTCL.
3. Feeders load profiles in proposed islands will be modelled as equivalent load at 132/ 66/33 kV feeders identified for multi-stage (stage-1 & stage-2 islanding as furnished in inquiry letter.
4. The under frequency relays and rate of change of under frequency relays will be modelled at Grid interfacing lines and load shedding candidate feeders as mentioned in point-3 above.
5. The steady state & dynamic performance of above simulated islanding schemes will be accessed for grid side simulated disturbance and initiating of islanding scheme by fall of frequency below target islanding frequency(s).
6. Sustainability for Stage-1 (to meet the priority load as provided by UPPTCL) islands will be accessed for N-1 generation/load contingency and if it fails to sustain, then sustainability of stage-2 islands will be explored. The prime objective of stage-2 islanding scheme will be to save loss of Generating unit(s).
7. Contingencies analysis for identified islanding schemes for loss of generation dispatch and load fluctuations and initiation of islanding at different possible islanding frequencies will be also be accessed.
8. As a deliverables for Stage-1 & Stage-2 islanding schemes, the feeder wise quantum of load, location & release of load at different under frequency relays and rate of change of under frequency relays during islanding, unit wise generation dispatch will be provided for the identified islanding frequency.
9. One day workshop for 10 no. of State load dispatch centre operation Engineers on the outcome of study regarding the above islanding schemes.

### **3.0 Overview of Agra Electrical System**

The transmission network of Agra consists of a main 765 kV Fatehabad substation feeding power to 400 kV Agra and 400kV Agra South. These 400 kV stations are feeding power to 220 KV and 132 KV substations in Agra Island. The island is also connected with 400 kV Mathura & 400kV Firozabad substations as shown in Fig.1 Proposed Agra Island. The solid lined represents the proposed connectivity in Agra Island and dotted lines are proposed to be opened.

The Lalitpur Super thermal Power Plant with ex-bus generation of  $610 \times 3 = 1830$  MW is identified generation for feeding the Agra island load. This generated Power will be transferred over 765kV transmission double circuit line to 765 kV Fatehabad substation located in Agra.

### **4.0 Islanding Scheme – Agra**

During Grid disturbance, Agra system shall endeavor to sustain through under frequency and  $df/dt$  load shedding already available in the system as first line of defense mechanism. However, if the system frequency fails to recover and continues to fall i.e. when grid disturbance is imminent, formation of Island will be resorted to as a last effort to prevent total collapse of the Agra system.

The Islanding scheme for Agra system has been designed by UPPTCL. At a frequency of 47.7 Hz, command for creation of island formation by opening tie lines feeding power to Agra island during pre-island except 765kV feeding power from Lalitpur TPS. -

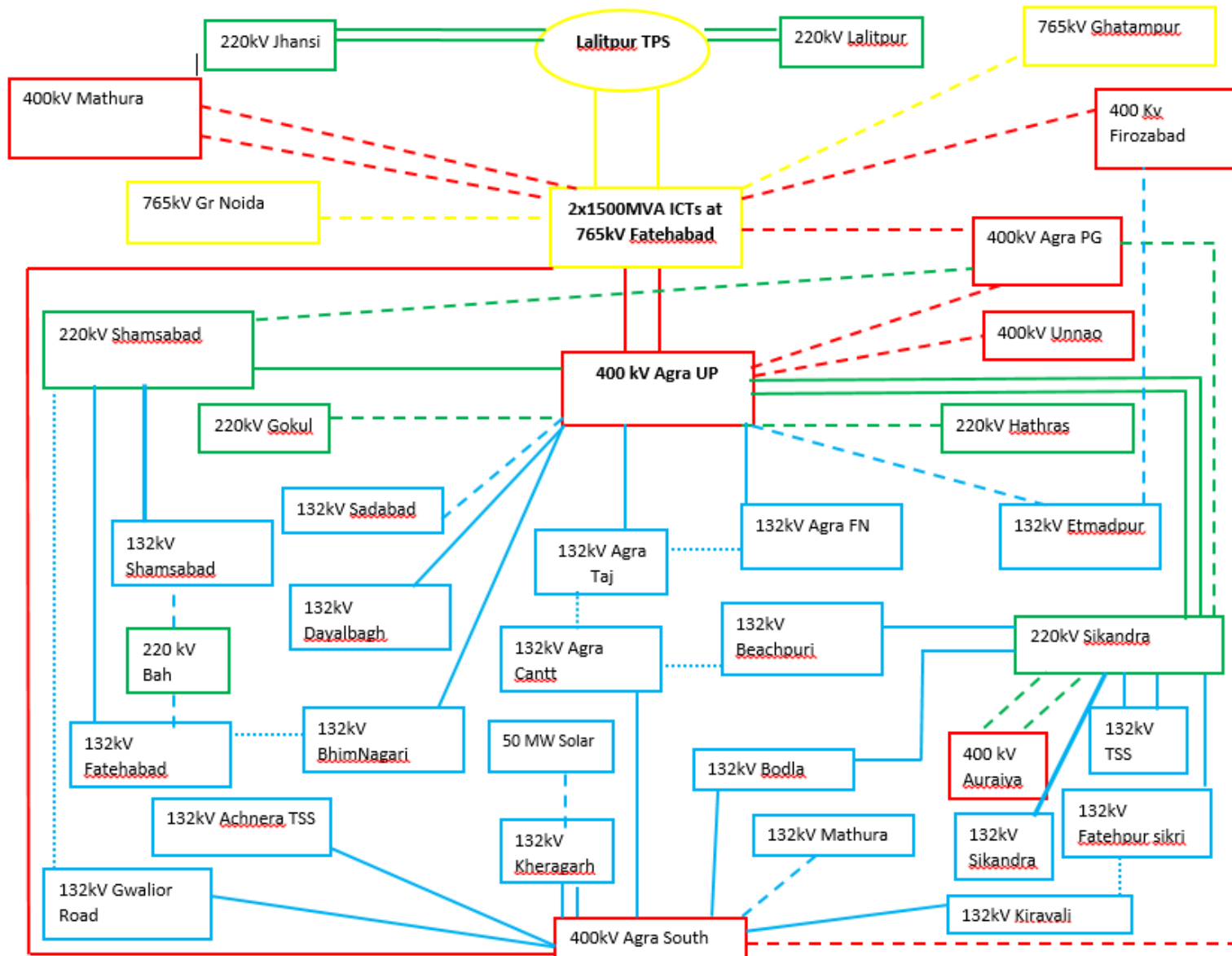

Fig.1.1(a) Proposed Agra Island (Agra side)



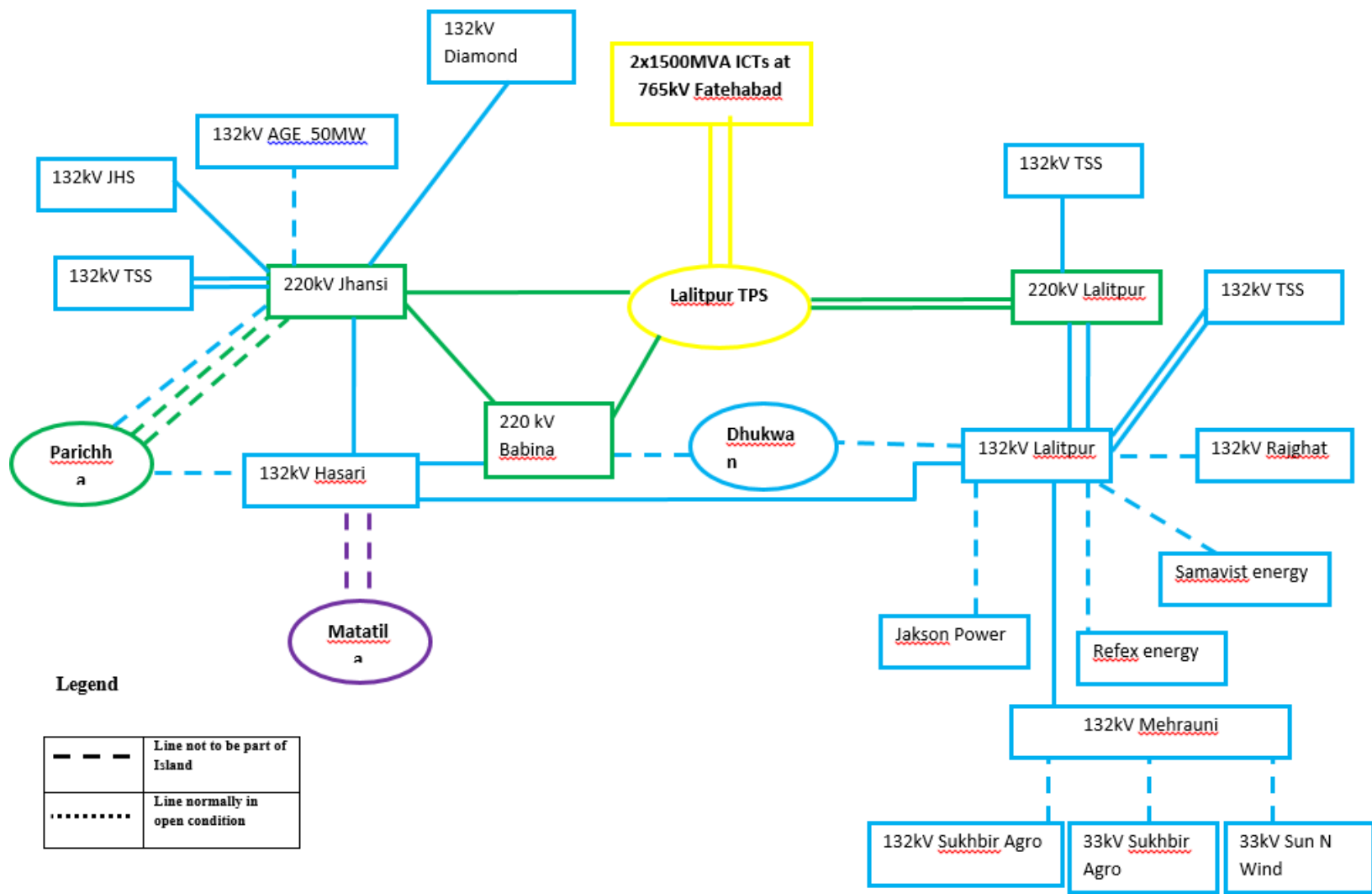

Fig.1.1(b) Proposed Agra Island (Lalitpur side)

## 5.0 Modelling of Agra Island

UPPTCL has provided operating network data in PSSE file and loading details for Agra Island for three different cases i.e. peak, off peak and normal loading operating scenarios. CPRI has modelled the provided loading details at 33 kV secondary side of Transformers. UPPTCL has also provided the schematics diagram of Proposed Island as shown in Fig.1 above. Stage-1 and Stage-2 loading details are also provided by UPPTCL.

The dynamic data of Generating units are Lalitpur in terms of Governor Data, exciter data are also provided and same technical permanents are used for dynamic modelling of these generating inputs. The under/over frequency settings of generating units are also provided by UPPTL to study the over frequency /under frequency tripping of machines during extreme load generation imbalance. The network as shown in Fig.1 is modelled in PSSE and network outside Agra Island has been modelled as equivalent generators exchanging pre-islanding schedule of active power, reactive power and bus voltage profiling.

## 6.0 Simulation Tool

The Siemens PTI PSS®E software package – a high performance transmission planning application for power industry, was used for the study, due to its high degree of flexibility supported by a modern graphical user interface. PSSE supplied by M/s Siemens is a high- performance technical computing environment for power flow, contingency analysis, short circuit and dynamic simulation in an integrated environment.

## 7.0 Methodology

To meet the objectives of the study following studies are to be carried for various operating scenarios such as peak load condition, off peak condition and normal loading condition.

- (i) **Power flow studies** – (a) for matching the pre-disturbance condition - to match closely the generation, loading and import/export conditions in the system (with grid connectivity condition) for that particular scenario (peak/off-peak/normal) (b) check load generation balance in each of the islands formed. Additional voltage profile in Agra Island, overloading of any components and losses are studied.
- (ii) **Stability studies** – to check dynamic repose of generating units against the prevailing loading scenarios expected at the time of island. Dynamic load generation balance to maintain the island frequency, avoiding the over frequency/under frequency tripping of machines, impact of technical

minima , quantum of load shedding needed in Agra island for survival of island.

## 8.0 Steady state Power Flow Analysis

The entire power system network of Agra is simulated in PSSE software with voltages down to the level where under frequency load tripping takes place i.e. 132/33 kV. The downstream loads have been lumped at 33 kV bus. Interstate connections with Agra system are represented as Generators with proper signs for Active and Reactive power depending on direction of the power flow (imports /exports).

The study has been performed for different for different generation units' combination against for three different loading scenarios as mentioned above.

### 8.1 Generation-load Agra

The case studied and summary of Power flow, loading details and losses summary is provided in Table.1 below. The unit's wise generation details are provided in Table.2.

**Table 8.1.1: The summary of Generation-load Agra for Different studies Cases.**

Cases Studied.	case	GEN		LOAD		LOSSES		POWER IMPORT		To bus shunt	from charging MVAR	To line shunt
		MW	MVAR	MW	MVAR	MW	MVAR	MW	MVAR	MVAR	MVAR	MVAR
Provided PSSE file	CASE-1	1375	136.8	846.6	278.3	26.4	385.8	-502	157	-774.1	2911.5	1767.1
Grid Connected island with summer peak load	CASE-2	1375	164.8	1337.3	439.4	45.9	576.6	-8.2	-484.7	772.5	1760.3	2899.3
Grid Connected island with winter peak off load	CASE-3	1375	94.3	842.3	276.9	25.9	365.6	506.7	-171.4	775.5	1770.1	2922.4
Grid Connected island with summer Avg load	CASE-4	1375	106.1	973.8	320.7	31.9	433.6	369.3	-275.2	774.7	1766.1	2913.9
Island Operation with summer peak load with-3 machines in operation	CASE-5	1382.9	484.5	1337.3	439.4	45.5	595.9	0	0	64.7	1129.3	1744.8
Island Operation with winter peak off load-3 machines in operation	CASE-6	857.4	-218.5	842.3	276.9	15	204.9	0	0	-23	1176.3	1853.7
Island Operation with summer avg load-3 machines in operation	CASE-7	995	-55	973.8	320.7	21.2	281.4	0	0	2.6	1162.1	1821.8
Island Operation with summer peak load with 332MW load shedding-2 machines in operation	CASE-8	1030.7	-17.7	1004.9	330.1	25.8	323.8	0	0	-16.6	1157.8	1812.9
Island Operation with summer peak load with 290MW load shedding-2 machines in operation	CASE-9	1078.4	343.7	1047.9	344.2	30.5	377.1	0	0	247.3	1129.3	1754.2
Island Operation with winter peak off load-2 machines in operation	CASE-10	861.9	663.1	842.3	276.9	19.6	252.3	0	0	733.4	1110.8	1710.3
Island Operation with summer avg load-2 machines in operation	CASE-11	1002.4	621.5	973.8	320.7	28.5	367.2	0	0	535	1113.1	1714.5

Table.8.1.2: Generation Schedule of Generating units Lalitpur TPS.

Case	Bus Number	157009	157009	157009	
	Bus Name	LALITPUR-TPS765.00	LALITPUR-TPS765.00	LALITPUR-TPS765.00	
	Id	T1	T2	T3	TOTAL
CASE-1	PGen (MW)	458	459	458	1375
	QGen (Mvar)	45.6	45.7	45.6	136.8
CASE-2	PGen (MW)	458	459	458	1375
	QGen (Mvar)	54.9	55.0	54.9	164.8
CASE-3	PGen (MW)	458	459	458	1375
	QGen (Mvar)	31.4	31.5	31.4	94.3
CASE-4	PGen (MW)	458	459	458	1375.0
	QGen (Mvar)	35.3	35.4	35.3	106.1
CASE-5	PGen (MW)	460.6	461.6	460.6	1382.9
	QGen (Mvar)	161.3	161.7	161.3	484.4
CASE-6	PGen (MW)	285.6	286.2	285.6	857.4
	QGen (Mvar)	-72.8	-72.9	-72.8	-218.5
CASE-7	PGen (MW)	331.4	332.2	331.4	995.0
	QGen (Mvar)	-18.3	-18.4	-18.3	-55.0
CASE-8	PGen (MW)	516.1	516.1	610.0	1642.2
	QGen (Mvar)	138.7	138.7	17.3	294.8
CASE-9	PGen (MW)	538.6	539.8	0.0	1078.4
	QGen (Mvar)	171.7	172.0	0.0	343.7
CASE-10	PGen (MW)	430.5	431.4	0.0	861.9
	QGen (Mvar)	331.2	331.9	0.0	663.1
CASE-11	PGen (MW)	500.6	501.7	0.0	1002.4
	QGen (Mvar)	310.4	311.1	0.0	621.5

## 8.2 Voltage Profile in Agra Island

The voltage profiling at all buses in Agra Network at 220/132/33 is obtained from simulation for different cases as listed above. It is observed that there is marginal fall in voltage a few buses. These voltage profiles may be improved by changing the transformers taps during island operation. These buses voltages are provided in Table 3 as under.

Table.8.2. Bus Voltage Profile

Bus Number	Bus Name	CASE-1	CASE-2	CASE-3	CASE-4	CASE-5	CASE-6	CASE-7	CASE-8	CASE-9	CASE-10	CASE-11
		Voltage (pu)	Voltage (pu)	Voltage (pu)	Voltage (pu)	Voltage (pu)	Voltage (pu)	Voltage (pu)	Voltage (pu)	Voltage (pu)	Voltage (pu)	Voltage (pu)
151005	AGRANI 132.00	0.9329	0.9167	0.9637	0.9482	0.9233	1.0831	1.0367	0.9871	0.9716	0.891	0.8761
151006	AGRACANT 132.00	0.9772	0.9471	0.9852	0.9664	0.9165	1.0529	1.0086	0.96	0.9464	0.912	0.8932
151008	AGRAFAN 132.00	0.9066	0.8809	0.9371	0.9206	0.897	1.0708	1.0223	0.9645	0.9482	0.8615	0.8454
151026	AGRATAJ 132.00	0.9043	0.8689	0.9446	0.9251	0.8884	1.0811	1.0299	0.9573	0.9406	0.8699	0.8506
151040	AGRA1 132.00	0.9661	0.9162	0.9649	0.9485	0.8736	1.0303	0.985	0.9405	0.9157	0.884	0.8674
151070	JHANSI2 132.00	1.006	0.9986	1.0101	1.0089	0.9235	0.9805	0.9758	0.9877	0.9877	0.948	0.943
151098	BHIMNAGR 132.00	0.9143	0.8899	0.9525	0.9325	0.903	1.0807	1.0296	0.9695	0.9533	0.8787	0.8587
151107	BODLA 132.00	0.9724	0.9233	0.9759	0.9564	0.8828	1.0396	0.993	0.938	0.919	0.8986	0.8786
151132	FATEHABA 132.00	0.9346	0.8448	0.9313	0.875	0.7941	1.0015	0.918	0.8839	0.8653	0.8446	0.7791
151165	JHANSI 132.00	0.9868	0.9895	1.0031	1.0031	0.9235	0.9795	0.9751	0.9968	0.9968	0.9488	0.9441
151187	SHAMSABA 132.00	0.9462	0.8789	0.9523	0.9111	0.8317	1.0199	0.9514	0.9156	0.8981	0.8695	0.8226
151225	KIRAWALI 132.00	0.9841	0.9564	0.9871	0.9757	0.9205	1.0482	1.0111	0.9725	0.9594	0.9142	0.9034
151259	LALITPUR 132.00	1.0375	0.9708	0.984	0.9963	0.9146	0.9539	0.9744	0.9709	0.9709	0.9306	0.9515
151386	DYALBAGH 132.00	0.9319	0.9152	0.9632	0.9471	0.9218	1.0827	1.0358	0.9871	0.9716	0.8904	0.8749
151417	LALITPUR UP 132.00	1.0364	0.9801	0.9902	1.0014	0.931	0.9649	0.9819	0.9784	0.9784	0.9444	0.9618
151424	AGRA SOUTH 132.00	0.9896	0.9658	0.9909	0.9813	0.9303	1.0517	1.0166	0.9725	0.9593	0.9182	0.9096

151452	KHERAGARH 132.00	0.9952	0.9858	0.9928	0.9911	0.9257	1.0439	1.0127	0.9684	0.955	0.905	0.9015
151464	MEHRAUNI 132.00	1.0443	0.9509	0.9702	0.982	0.8854	0.9326	0.9528	0.9718	0.9718	0.9085	0.9292
151490	GWALIOR RD 132.00	0.98	0.9381	0.9624	0.9574	0.9077	1.0326	1.0007	0.9519	0.9381	0.8865	0.8831
151491	BICHPURI 132.00	0.9537	0.9001	0.9564	0.9357	0.8606	1.0274	0.9774	0.9293	0.9038	0.8747	0.8531
151607	BABINA 132.00	1.0338	0.9895	1.0031	1.0031	0.9235	0.9795	0.9751	0.9968	0.9968	0.9488	0.9441
151628	ACHNERA TSS 132.00	0.9897	0.9639	0.991	0.9811	0.9285	1.0518	1.0164	0.9707	0.9575	0.9184	0.9093
151632	FATEHPR SKRII 132.00	0.9773	0.8944	0.9576	0.9336	0.8504	1.0237	0.9708	0.9195	0.8939	0.8758	0.8507
152004	AGRAN2 220.00	0.9831	0.9633	0.988	0.9783	0.9261	1.0507	1.0129	0.9726	0.9587	0.9125	0.9053
152016	SHAMSHAB 220.00	0.9635	0.9215	0.9697	0.9448	0.8796	1.0348	0.9821	0.9419	0.9263	0.8908	0.8645
152049	SIKANDR2 220.00	0.9841	0.9639	0.989	0.9794	0.9209	1.0486	1.0101	0.9695	0.9545	0.9097	0.9017
152080	JHANSI2 220.00	1.0286	1.023	1.0251	1.0252	0.9392	0.9833	0.9814	0.9926	0.9926	0.9608	0.9588
152109	LALITPUR-TPS 220.00	1.0335	1.002	1.0057	1.0079	0.9697	0.9902	0.9929	0.9962	0.9962	0.9795	0.9823
152120	LALITPURUP 220.00	1.0341	0.9978	1.0026	1.0063	0.9626	0.9854	0.9905	0.9926	0.9926	0.9735	0.9787
152179	BABINA 220.00	1.0331	1.0031	1.0107	1.0114	0.9383	0.9823	0.9805	0.9943	0.9943	0.9601	0.9581
153301	JHS 33KV 33.000	NA	0.971	0.9948	0.9897	0.8931	0.9647	0.9558	0.9598	0.9598	0.9316	0.9223
153302	JHS-TSS1 132.00	NA	0.9961	1.0083	1.0072	0.9208	0.9786	0.9741	0.9851	0.9851	0.946	0.9412
153303	JHS-TSS2 132.00	NA	0.9961	1.0083	1.0072	0.9208	0.9786	0.9741	0.9851	0.9851	0.946	0.9412
153304	DIAMOND 132.00	NA	0.9975	1.0097	1.0081	0.9223	0.9801	0.975	0.9866	0.9866	0.9476	0.9422
153305	JHS2 33KV 33.000	NA	0.9583	0.9872	0.9804	0.8895	0.9631	0.9516	0.9968	0.9968	0.9318	0.9197
153306	BABINA 33.000	NA	0.9887	1.0031	1.0031	0.9228	0.9795	0.9751	0.996	0.996	0.9488	0.9441
153307	LALITPUR 33.000	NA	0.9608	0.9641	0.9913	0.9105	0.9379	0.9716	0.9591	0.9591	0.9167	0.9513
153308	LALITPUR TSS1 132.00	NA	0.9759	0.9879	1.0006	0.9267	0.9625	0.981	0.9742	0.9742	0.942	0.9609
153309	LLTPR 33.000	NA	0.9477	0.9647	0.984	0.8898	0.934	0.9617	0.9478	0.9478	0.91	0.9385
153310	LLTPR TSS-1 132.00	NA	0.9665	0.9809	0.9948	0.91	0.9508	0.9729	0.9665	0.9665	0.9273	0.9499
153311	LLTPR TSS-2 132.00	NA	0.9665	0.9791	0.9948	0.91	0.9489	0.9729	0.9665	0.9665	0.9254	0.9499
153312	MEHRAUNI 33.000	NA	0.9255	0.9507	0.962	0.8576	0.9122	0.932	0.9718	0.9718	0.8874	0.9078
153314	DYALBAGH 33.000	NA	0.8781	0.9518	0.922	0.8852	1.0726	1.0132	0.9871	0.9716	0.878	0.8472
153315	BHIMNGR 33.000	NA	0.8636	0.9413	0.9169	0.8772	1.0709	1.0157	0.9458	0.9292	0.8664	0.8416
153316	AGRA TAJ 33.000	NA	0.8424	0.9338	0.912	0.8626	1.0717	1.0183	0.9338	0.9166	0.8581	0.8362
153317	FOUNDRY NGR 33.000	NA	0.8539	0.917	0.8996	0.8706	1.0535	1.0037	0.9403	0.9234	0.8392	0.8222
153319	KHRGARH 33.000	NA	0.9699	0.9665	0.9748	0.9085	1.0191	0.9968	0.9521	0.9385	0.8755	0.8833
153320	GWLIOR RD 33.000	NA	0.9112	0.9345	0.9339	0.8797	1.0071	0.9785	0.9254	0.9112	0.8557	0.8572
153321	AGHRA CANT 33.000	NA	0.921	0.9771	0.9456	0.8894	1.0453	0.9887	0.9344	0.9203	0.9032	0.8704
153322	BODLA 33.000	NA	0.8786	0.9614	0.9297	0.8352	1.026	0.9675	0.8943	0.8741	0.8827	0.8489
153323	KIRAWALI 33.000	NA	0.9279	0.9758	0.9586	0.8907	1.0376	0.9947	0.9725	0.9594	0.9018	0.8848
153324	SIKANDRA 33.000	NA	0.9017	0.9561	0.9394	0.8583	1.0221	0.9763	0.9405	0.9072	0.8744	0.8574
153325	SIKANDRA TSS-1 132.00	NA	0.9129	0.9619	0.9458	0.8702	1.0276	0.9824	0.9373	0.9124	0.8809	0.8645
153326	SIKANDRA TSS2 132.00	NA	0.913	0.9621	0.9459	0.8703	1.0278	0.9825	0.9374	0.9125	0.881	0.8646
153327	BEACHPURI 33.000	NA	0.8768	0.9441	0.9172	0.836	1.016	0.9598	0.9069	0.8807	0.8611	0.8325
153328	FATEHPUR SIK 33.000	NA	0.8806	0.9524	0.9238	0.8358	1.0189	0.9615	0.906	0.88	0.8701	0.8399
153329	SHAMSABD 22033.000	NA	0.8346	0.9332	0.8803	0.7838	1.0023	0.9222	0.8737	0.8551	0.8483	0.7873
153331	FATEHBD 33.000	NA	0.8177	0.9128	0.8464	0.7648	0.9845	0.891	0.8583	0.8391	0.8239	0.7459
154000	AGRAUP4 400.00	1.0041	0.9949	1.0063	1.0019	0.9522	1.048	1.0192	0.983	0.9722	0.9307	0.934
154058	AGRA_SOUTH 400.00	1.0014	0.9886	1.0029	0.9975	0.9533	1.0471	1.0196	0.982	0.9716	0.9376	0.936
154073	FATEHBD_AGRA 400.00	1.0054	0.9988	1.007	1.0039	0.9747	1.0443	1.0236	0.9913	0.9836	0.9525	0.9571
157009	LALITPUR-TPS 765.00	1	1	1	1	1	1	1	1	1	1	1
157013	FATEHBD_AGRA 765.00	1.0053	1.0022	1.0066	1.0048	0.9889	1.0371	1.0227	0.9942	0.9888	0.9691	0.9716

### 8.3 Loading Details in Agra Island

The aggregated Total load of AGRA is MW and MVar. The detailed breakup of this load modelled at 220/132/33 buses is given in Table 4 below.

**Table.8.3: Agra Island Load.**

Bus Number	Bus Name	Id	STAGE-1					
			Summer Peak island load		winter Off Peak island load		Summer Avg island load	
			Pload (MW)	Qload (Mvar)	Pload (MW)	Qload (Mvar)	Pload (MW)	Qload (Mvar)
151628	ACHNERA_TSS 132.00	1	16	5.00	0	0	2	1.25
153301	JHS 33KV 33.000	1	22	7.23	15	4.93	18	5.916
153301	JHS 33KV 33.000	2	29	9.53	15	4.93	19	6.2446
153302	JHS-TSS1 132.00	1	15	4.93	11	3.62	10	3.2867
153303	JHS-TSS2 132.00	1	15	4.93	11	3.62	10	3.2867

153304	DIAMOND	132.00	1	13	4.27	5	1.64	9	2.958
153305	JHS2 33KV	33.000	1	42	13.81	24	7.89	30	9.8607
153305	JHS2 33KV	33.000	2	45	14.79	26	8.55	32	10.5181
153305	JHS2 33KV	33.000	3	30	9.86	14	4.60	27	8.8746
153306	BABINA	33.000	1	1.5	0.49	0	0.00	0	0
153307	LALITPUR	33.000	1	9	2.96	12	3.95	5	1.6466
153307	LALITPUR	33.000	2	9	2.96	12	3.95	5	1.6466
153308	LALITPUR TSS	132.00	1	17	5.60	9.6	3.16	4	1.3173
153309	LLTPR	33.000	1	21	6.92	18	5.93	12	3.9518
153309	LLTPR	33.000	2	21	6.92	18	5.93	12	3.9518
153310	LLTPR TSS-1	132.00	1	22	7.25	16	5.27	8	2.6345
153311	LLTPR TSS-2	132.00	1	22	7.25	25	8.23	8	2.6345
153312	MEHRAUNI	33.000	1	33.6	11.07	27	8.89	28	9.2209
153314	DYALBAGH	33.000	1	60	19.72	21.6	7.10	44.3	14.5602
153315	BHIMNGR	33.000	1	21.48	7.06	10.51	3.45	14	4.6011
153315	BHIMNGR	33.000	2	21.48	7.06	10.51	3.45	14	4.6011
153316	AGRA TAJ	33.000	1	15.77	5.18	11	3.62	12	3.944
153316	AGRA TAJ	33.000	2	43.68	14.36	15	4.93	18	5.916
153316	AGRA TAJ	33.000	3	16	5.26	10	3.29	12	3.944
153317	FOUNDRY NGR	33.000	1	78	25.64	64	21.03	65	21.363
153319	KHRGARH	33.000	1	15.6	5.13	23.7	7.79	16	5.2595
153319	KHRGARH	33.000	2	14.8	4.87	24.8	8.15	15.2	4.9965
153320	GWLIOR RD	33.000	1	20.66	6.79	20.49	6.73	20.03	6.5832
153320	GWLIOR RD	33.000	2	25.92	8.52	28.83	9.48	21.96	7.2176
153321	AGHRA CANT	33.000	1	72	23.67	25	8.22	60	19.7243
153322	BODLA	33.000	1	33.84	11.12	6.8587	2.25	23.7769	7.8151
153322	BODLA	33.000	2	36.58	12.02	21.7193	7.14	25.1486	8.266
153322	BODLA	33.000	3	56.7	18.64	20.5762	6.76	35.4367	11.6475
153323	KIRAWALI	33.000	1	50	16.43	22	7.23	32	10.5174
153324	SIKANDRA	33.000	1	28.81	9.47	12.1171	3.98	14.6319	4.8094
153324	SIKANDRA	33.000	2	42.98	14.13	34.7509	11.42	32.9219	10.8212
153325	SIKNDRA TSS	132.00	1	33.84	11.12	31.5501	10.37	28.3494	9.3183
153326	SIKANDRA TSS	132.00	1	32.46	10.67	29.7211	9.77	27.2063	8.9425
153327	BEACHPURI	33.000	1	39	12.82	23	7.56	33	10.8474
153328	FATEHPUR SIK	33.000	1	24	7.88	10	3.28	18	5.9069
153329	SHAMSABD	22033.000	1	52.5	17.26	27.2	8.94	40.1	13.1814
153329	SHAMSABD	22033.000	2	52.5	17.26	27.2	8.94	40.1	13.1814
153331	FATEHBD	33.000	1	35.9	11.80	25.8	8.48	30.2	9.9272
153331	FATEHBD	33.000	2	29.72	9.77	25.8	8.48	41.45	13.6252
			<b>TOTAL</b>	<b>1337.3</b>	<b>439.4</b>	<b>842.3</b>	<b>276.9</b>	<b>973.8</b>	<b>320.7</b>

#### 8.4 Tie line Power Flow

The Exchange of Power in terms of MW and MVar of Agra with outside Agra Island is listed in Table 5 for different studied cases.

Table.8.4.1: Inter Area Power flow

FROM AREA	TO AREA	CASE-1		CASE-2		CASE-3		CASE-4	
		MW	MVar	MW	MVar	MW	MVar	MW	MVar
AGRA	UTTARPRADESH	1529.6	326	1268.5	115.2	1538	276.8	1486.2	233.6
	NR_ISTS_UP	-895.3	-455.5	-1120.3	-555	-903.9	-425.3	-978.4	-477.3
	AURAIYA	-132.3	-27.5	-156.3	-44.9	-127.3	-22.9	-138.6	-31.5
	<b>TOTAL</b>	<b>502</b>	<b>-157</b>	<b>-8.1</b>	<b>-484.7</b>	<b>506.8</b>	<b>-171.4</b>	<b>369.2</b>	<b>-275.2</b>

Table.8.4.2: Tie line Power Flow

FROM BUS	NAME	TO BUS	NAME	CKT	CASE-1		CASE-2		CASE-3		CASE-4	
					MW	MVA R	MW	MVA R	MW	MVA R	MW	MVA R
151005	AGRAN1 132.00*	151129	ETMADPUR 132.00	1	-33.8	-1.9	-30.4	-8.3	-1.5	0.8	-11.7	-2.1
151005	AGRAN1 132.00*	151178	SADABAD 132.00	1	59.3	12.1	59.3	12.5	59.2	11.3	59.2	11.7
151070	JHANSI2 132.00	151317	PARICHHA 132.00*	1	2.5	-2.9	-3.5	-9.3	9.5	-4.2	7.8	-4.9
151070	JHANSI2 132.00	151595	ADANI GR SLR132.00*	1	-37	0	-37	0	-37	0	-37	0
151165	JHANSI 132.00	151317	PARICHHA 132.00*	1	-46.7	-18.9	-18.2	-20.8	-1.4	-12.7	0.6	-12.9
151259	LALITPUR 132.00	151569	UDAYPURA_TSS132.00*	1	0	0	0	0	0	0	0	0
151259	LALITPUR 132.00	151608	DUKHWAN_THDC132.00*	2	10	1.3	-19.3	-16.6	-21.5	-16.7	2.6	-9.9
151424	AGRA_SOUTH 132.00	151273	MATHURA 132.00*	1	39.6	13	39.6	13	39.6	13	39.6	13
151452	KHERAGARH 132.00*	151766	JACKSON_SLR 132.00	1	-36.9	-14.3	-36.6	-71.2	-36.9	-28.9	-36.8	-39.3
151464	MEHRAUNI 132.00*	151465	SUKHBIR_SLR 132.00	1	-14.8	-0.6	-14.8	-0.5	-14.8	-0.5	-14.8	-0.5
151607	BABINA 132.00*	151608	DUKHWAN_THDC132.00	2	-10	-1.9	19.3	16.2	21.6	16.2	-2.5	9.3
152004	AGRAN2 220.00	152001	GOKUL 220.00*	1	137.5	13.4	123.9	2.4	143.5	15.8	135	10.5
152004	AGRAN2 220.00*	152010	HATHRAS2 220.00	1	128.1	30.8	112.7	18.1	133	33.9	124.4	27.6
152080	JHANSI2 220.00	152053	PARICHA2 220.00*	1	-21.1	-7.9	-42.4	-54.6	-18	-39.5	-16.1	-38.9
152080	JHANSI2 220.00	152053	PARICHA2 220.00*	2	-21.1	-7.9	-42.4	-54.6	-18	-39.5	-16.1	-38.9
154000	AGRAUP4 400.00*	154001	UNNAO4 400.00	T1	-13.8	-0.2	-34.9	-11	-13.7	3.2	-21.5	-2.5
154058	AGRA_SOUTH 400.00*	154092	FIROZABD_400400.00	T1	-73.2	-24.5	-140.3	-50.7	-77.6	-25.7	-99.8	-35.3
154073	FATEHBD_AGRA400.00	154079	MATHURA 400.00*	T1	205.7	64.1	199.3	64.2	201.8	64.4	201.9	64.4
154073	FATEHBD_AGRA400.00	154079	MATHURA 400.00*	T2	290.3	63	281.3	63.6	284.8	63.4	284.9	63.5
154073	FATEHBD_AGRA400.00	154092	FIROZABD_400400.00*	T1	327.9	62.3	364.1	85.9	307.6	57.7	328.3	67.3
157013	FATEHBD_AGRA765.00	157011	GR.NOIDA 765.00*	B1	637	147	488.7	136.8	577.9	164.6	558.3	151.6
157013	FATEHBD_AGRA765.00	157023	GHATAMPUR 765.00*	B1	0	0	0	0	0	0	0	0
152049	SIKANDR2 220.00	152115	AGRA-PG 220.00*	1	-37	-28.2	-58.3	-43.9	-31.5	-24.7	-42.3	-32
154000	AGRAUP4 400.00*	154034	AGRA 400.00	T2	-532.8	-265.9	-639.5	-329.3	-525.5	-247.2	-567.9	-280.4
154073	FATEHBD_AGRA400.00	154034	AGRA 400.00*	T1	-325.5	-161.3	-422.5	-181.8	-347	-153.5	-368.2	-164.9
152049	SIKANDR2 220.00*	154060	AURYA2 220.00	1	-66.2	-13.8	-78.2	-22.4	-63.7	-11.5	-69.3	-15.8
152049	SIKANDR2 220.00*	154060	AURYA2 220.00	2	-66.2	-13.8	-78.2	-22.4	-63.7	-11.5	-69.3	-15.8
				<b>TOTAL</b>	<b>502</b>	<b>-157</b>	<b>-8.1</b>	<b>-484.7</b>	<b>506.8</b>	<b>-171.4</b>	<b>369.2</b>	<b>275.2</b>

## 8.5 Line Loading

The MVA loading of lines for Different scenario is studied

Table.8.5: Line loading

	From Bus	Name	Kv	To Bus	Name	MVA	Rating	%
CASE_1	151005	AGRAN1	132	151008	AGRAFN	96	92	104.4
	151005	AGRAN1	132	151026	AGRATAJ	94.1	92	102.3
	151107	BODLA	132.00*	151424	AGRA_SOUTH	144.9	92	157.5
	151225	KIRAWALI	132.00*	151424	AGRA_SOUTH	93.7	92	101.9
CASE-2	151005	AGRAN1	132	151008	AGRAFN	73.5	47	156.4
	151005	AGRAN1	132	151178	SADABAD	62.8	47	133.5
	151107	BODLA	132	151424	AGRA_SOUTH	50.1	47	106.5
	151132	FATEHABA	132.00*	151187	SHAMSABA	56.9	47	121
	151225	KIRAWALI	132.00*	151424	AGRA_SOUTH	52.1	47	110.8
	151259	LALITPUR	132.00*	151608	DUKHWAN_THDC	51.5	47	109.6
	151424	AGRA_SOUTH	132	151490	GWALIOR_RD	55.5	47	118.1
	151452	KHERAGARH	132.00*	151766	JACKSON_SLR	45.9	47	97.7
151607	BABINA	132	151608	DUKHWAN_THDC	51.2	47	109	

	152001	GOKUL	220.00*	152004	AGRAN2	147.7	131	112.8
	152004	AGRAN2	220	152010	HATHRAS2	141.3	131	107.9
	154000	AGRAUP4	400.00*	154034	AGRA	566.3	517	109.5
CASE-3	151107	BODLA	132.00*	151424	AGRA_SOUTH	89.5	84	106.6
	151132	FATEHABA	132.00*	151187	SHAMSABA	86.1	84	102.5
CASE-4	151005	AGRAN1	132	151008	AGRAFN	89.6	92	97.4
	151005	AGRAN1	132	151026	AGRATAJ	87.4	92	95
	151107	BODLA	132.00*	151424	AGRA_SOUTH	184.4	92	200.5
	151165	JHANSI	132	151607	BABINA	146.2	92	158.9
CASE-5	151005	AGRAN1	132	151008	AGRAFN	89.1	92	96.9
	151107	BODLA	132.00*	151424	AGRA_SOUTH	186	92	202.2
	151132	FATEHABA	132.00*	151187	SHAMSABA	87.5	92	95.1
	151165	JHANSI	132	151607	BABINA	143	92	155.4
	152004	AGRAN2	220	152016	SHAMSHAB	228	229	99.6
CASE-6	151005	AGRAN1	132	151008	AGRAFN	59.9	47	127.5
	151107	BODLA	132.00*	151424	AGRA_SOUTH	75.8	47	161.3
	151132	FATEHABA	132.00*	151187	SHAMSABA	52.5	47	111.7
	151165	JHANSI	132	151607	BABINA	83.7	47	178.1
	151259	LALITPUR	132.00*	151417	LALITPUR UP	48.5	47	103.1
	151259	LALITPUR	132.00*	151417	LALITPUR UP	48.5	47	103.1
	151424	AGRA_SOUTH	132	151490	GWALIOR_RD	48.7	47	103.7
CASE-7	151107	BODLA	132.00*	151424	AGRA_SOUTH	112.5	84	133.9
	151132	FATEHABA	132.00*	151187	SHAMSABA	81.6	84	97.2
	151165	JHANSI	132	151607	BABINA	93.2	90	103.6
CASE-8	151005	AGRAN1	132	151008	AGRAFN	82.2	84	97.9
	151005	AGRAN1	132	151026	AGRATAJ	80	84	95.3
	151107	BODLA	132.00*	151424	AGRA_SOUTH	144.7	84	172.2
CASE-9	151005	AGRAN1	132	151008	AGRAFN	83.8	84	99.7
	151005	AGRAN1	132	151026	AGRATAJ	81.6	84	97.2
	151107	BODLA	132.00*	151424	AGRA_SOUTH	166.5	84	198.2
	152004	AGRAN2	220	152016	SHAMSHAB	199.6	208	95.9
CASE-10	151005	AGRAN1	132	151008	AGRAFN	80.3	47	170.8
	151107	BODLA	132.00*	151424	AGRA_SOUTH	91.4	47	194.5
	151132	FATEHABA	132.00*	151187	SHAMSABA	63.3	47	134.7
	151165	JHANSI	132	151607	BABINA	90.2	47	191.9
	151259	LALITPUR	132.00*	151417	LALITPUR UP	52.1	47	110.8
	151259	LALITPUR	132.00*	151417	LALITPUR UP	52.1	47	110.8
	151424	AGRA_SOUTH	132	151490	GWALIOR_RD	60.7	47	129.1
	152004	AGRAN2	220	152016	SHAMSHAB	130.3	131	99.5
CASE-11	151005	AGRAN1	132	151008	AGRAFN	83.2	84	99.1
	151107	BODLA	132.00*	151424	AGRA_SOUTH	131	84	155.9
	151132	FATEHABA	132.00*	151187	SHAMSABA	98.2	84	117
	151165	JHANSI	132	151607	BABINA	101.2	90	112.5
	152004	AGRAN2	220	152016	SHAMSHAB	205.1	208	98.6

## 8.6 Transformer Loading

No transformer in Agra Island is getting over loaded during any of the above studies cases above and it is observed that sufficient transformer MVA capacity is available at 400/220/132 kV substations of Agra to transfer power from ISTS/neighboring utilities to downstream network of Agra.



## 9.0 Dynamic modelling

Post islanding frequency stability was studied through extensive simulations in PSS/E. Power flow data was obtained using the inbuilt network reduction tool in PSS/E. The negative loads in the boundary buses in the external system was modelled with generators. Dynamic model of the generators and associated controls was built with inbuilt model library.

### 9.1 Modelling of Generator

The generator was modelled with a GENROU model in PSS/E. Considering machine MVA base as 777 MVA. GENROU represents the round rotor synchronous generator model. The parameter values are given in Table I.

**Table I: GENROU Model of Synchronous Generator**

Parameter	Values	Parameter	Values
Tdo'	7.94	Xq	2.3192
Tdo''	0.05	Xd'	0.3347
Tqo'	0.836	Xq'	0.8661
Tqo''	0.07	Xd''=Xq''	0.2495
H	3.7	Xl	0.1749
D	0	S1.0	0
Xd	2.4413	S1.2	0

### 9.2 Generator Controls

The generators are equipped with Exciter, PSS and Turbine-Governor controls. Modelling of the generator control are given as follows:

#### 9.2.1 Modelling of Exciter

The exciter was modelled with ESAC1A model AC exciter in PSS/E. The block diagram model is provided below and the parameters are provided in Table II.



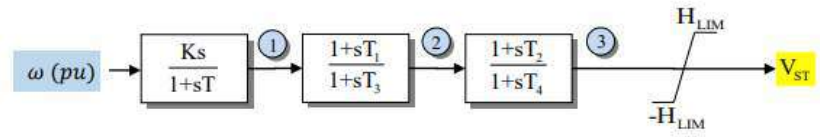

### 9.2.3 Turbine Governor Model

Prime Mover controls were modelled with IEEEG1 model in PSS/E. The block diagram model is provided below and the parameter values for the IEEEG1 model are provided in Table IV.

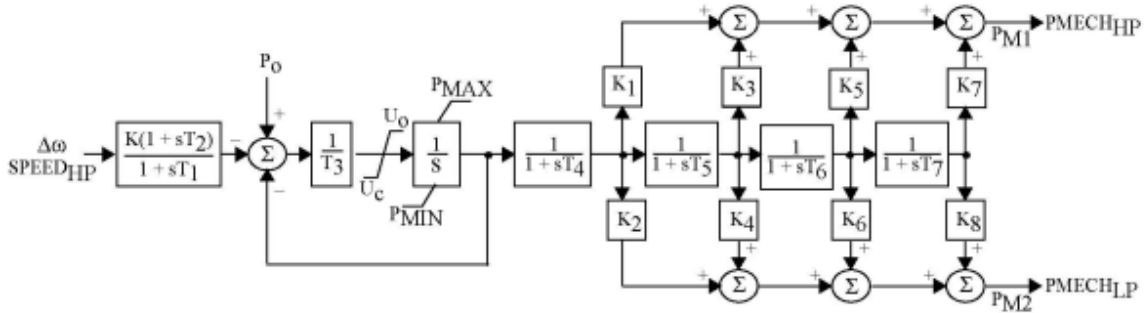

Table IV: IEEEG1 Model of the Turbine-Governor

Parameter	Values	Parameter	Values
K	20	K2	0
T1	0	T5	16
T2	0	K3	0.38
T3	0.125	K4	0
U0	0.4	T6	0.54
Uc<0	-0.4	K5	0.35
P_MAX	0.79	K6	0
P_MIN	0	T7	0
T4	0.18	K7	0
K1	0.27	K8	0

### 9.3 Relay Settings

Islanding Frequency: Islanding is initiated at 47.9 Hz. This data was provided to CPRI. Post islanded frequency stability of the island power system is ensured by several relays- under

frequency load shedding (UFLS), over frequency generator tripping (OFGT) and over frequency load reconnection (OFLR). Settings of these relays are obtained by extensive simulation studies.

### 9.3.1 Under Frequency Load Shedding (UFLS) Relay Settings

The existing generator has a protection scheme that trips the generator at 47.5 Hz with 3 seconds delay. The frequency margin from the islanding frequency is too low. Therefore, load shedding has to be done in large steps to avoid under frequency generation tripping. As per the islanding test cases simulated for different loading conditions and different initial powers of the generator, under frequency load shedding (UFLS) happens only for high/peak load conditions. Considering two generators ON at 340 MW each (total 680 MW) and peak load demand 1377 MW (1337 MW of load and 3% transmission loss), a total of 676 MW of loads need to be tripped to get a total demand reduction of 696 MW (includes roughly 3% transmission loss) which results in generation requirement of (1377-696) MW of 680 MW. For any other scenario, the amount of load shedding required is either Nil or less than 676 MW. Therefore, a total of 684.37 MW load shedding is suggested in multiple stages. Details of loads tripped in different UFLS Stages are provided in Table V and the proposed Agra island after stage I, stage II and stage III load shedding is shown in Fig 1.2, Fig 1.3 and Fig 1.4 respectively (Disconnection of loads is shown by black dotted lines).

**Table V: UFLS Relay Settings and Loads Tripped During Summer**

	<b>Bus Name</b>	<b>Bus Number</b>	<b>Pload (MW)</b>	<b>Load Tripped in Stages</b>	<b>Total load tripped (MW)</b>
UFLS Stage-1 f<47.6 Hz	JHS2 33KV 33.000	153305	42		
	JHS2 33KV 33.000	153305	45		
	JHS2 33KV 33.000	153305	30		
	BHIMNGR 33.000	153315	21.48		
	BHIMNGR 33.000	153315	21.48		
	KIRAWALI 33.000	153323	50		
	SIKANDRA 33.000	153324	28.81		
	SIKANDRA 33.000	153324	42.98		
	FATEHBD 33.000	153331	35.9		
	FATEHBD 33.000	153331	29.72	347.37	347.37
UFLS Stage-2 f<47.3 Hz	FOUNDRY NGR 33.000	153317	78		
	AGHRA CANT 33.000	153321	72		
	BEACHPURI 33.000	153327	39	189	536.37
UFLS Stage-3 f<47.1 Hz	MEHRAUNI 33.000	153312	33.6		
	DYALBAGH 33.000	153314	60		
	KHRGARH 33.000	153319	15.6		
	KHRGARH 33.000	153319	14.8		
	FATEHPUR SIK33.000	153328	24	148	684.37

Considering a ROCOF of 2Hz/s for Indian Grid, time taken for frequency to reach from 47.9 Hz to 47.6 Hz is 0.15s. This is sufficient for all the tie lines to be opened to create the island. With UFLS Stage-1, ROCOF is expected to reduce. Therefore, the frequency difference between Stage-2 and Stage-3 (i.e. 0.2Hz) is lesser as compared to frequency difference between Stage-1 and Stage-2 (i.e. 0.3Hz).

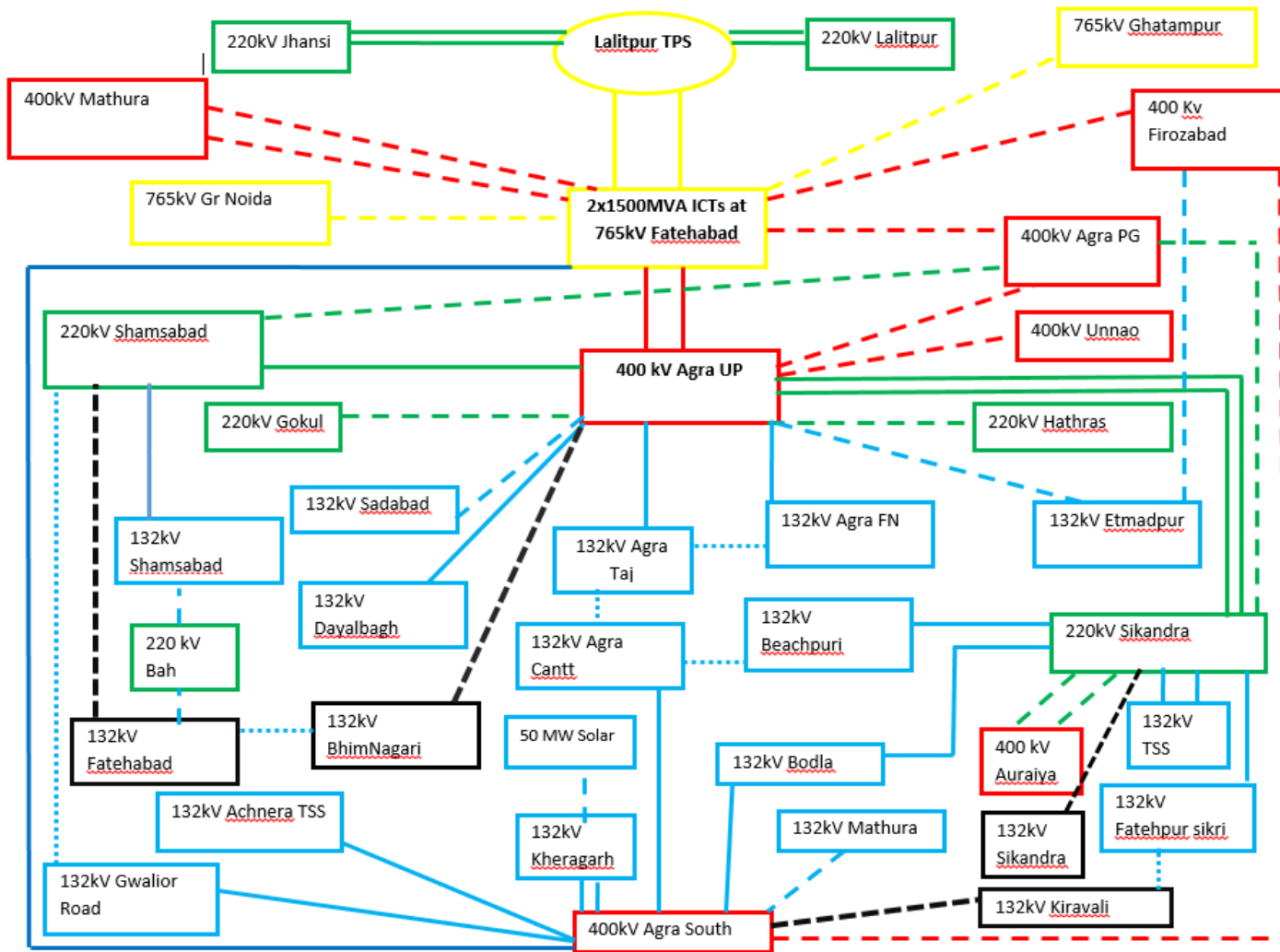

**Fig. 1.2(a) Agra Island after Stage-I load shedding**

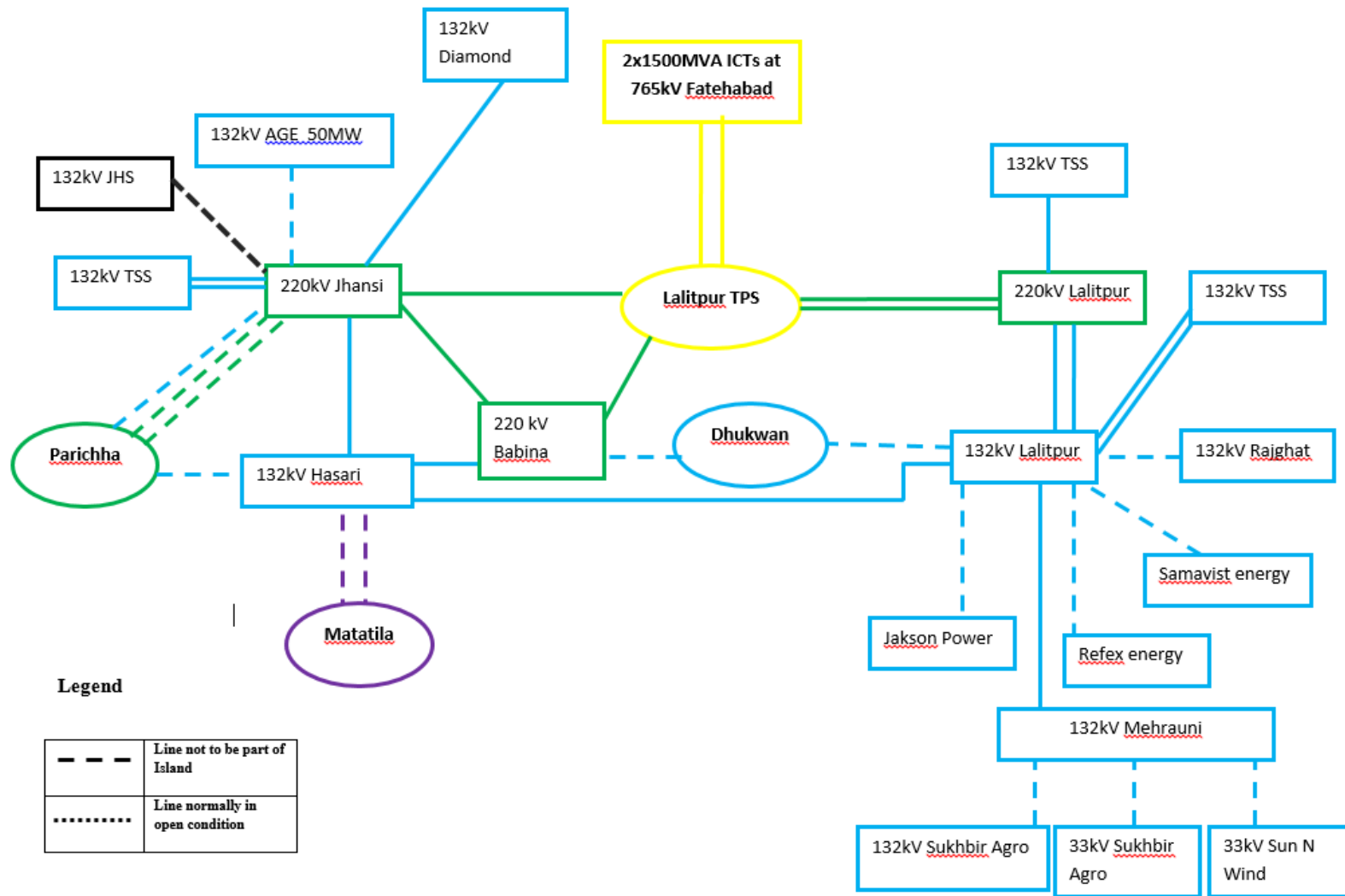
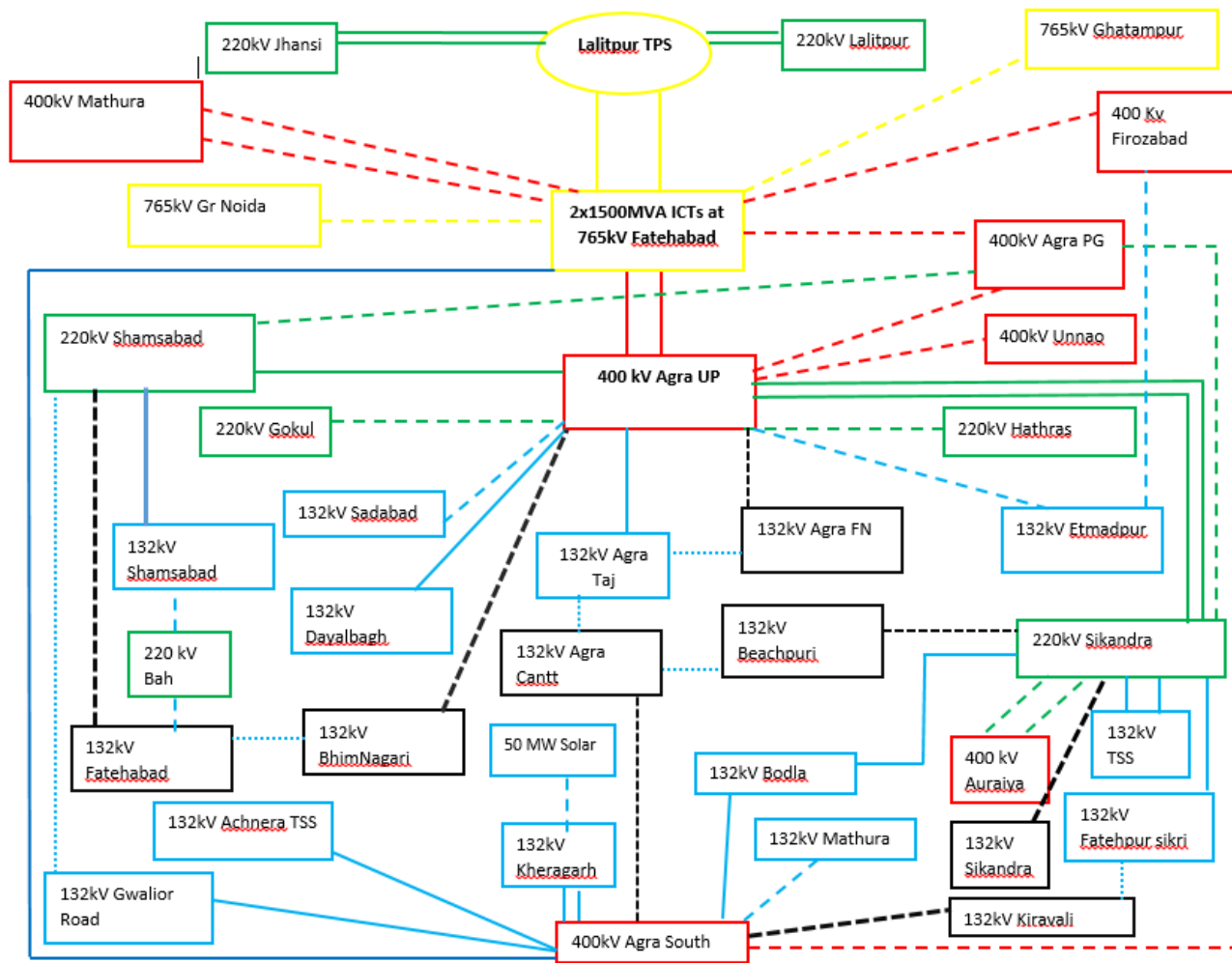
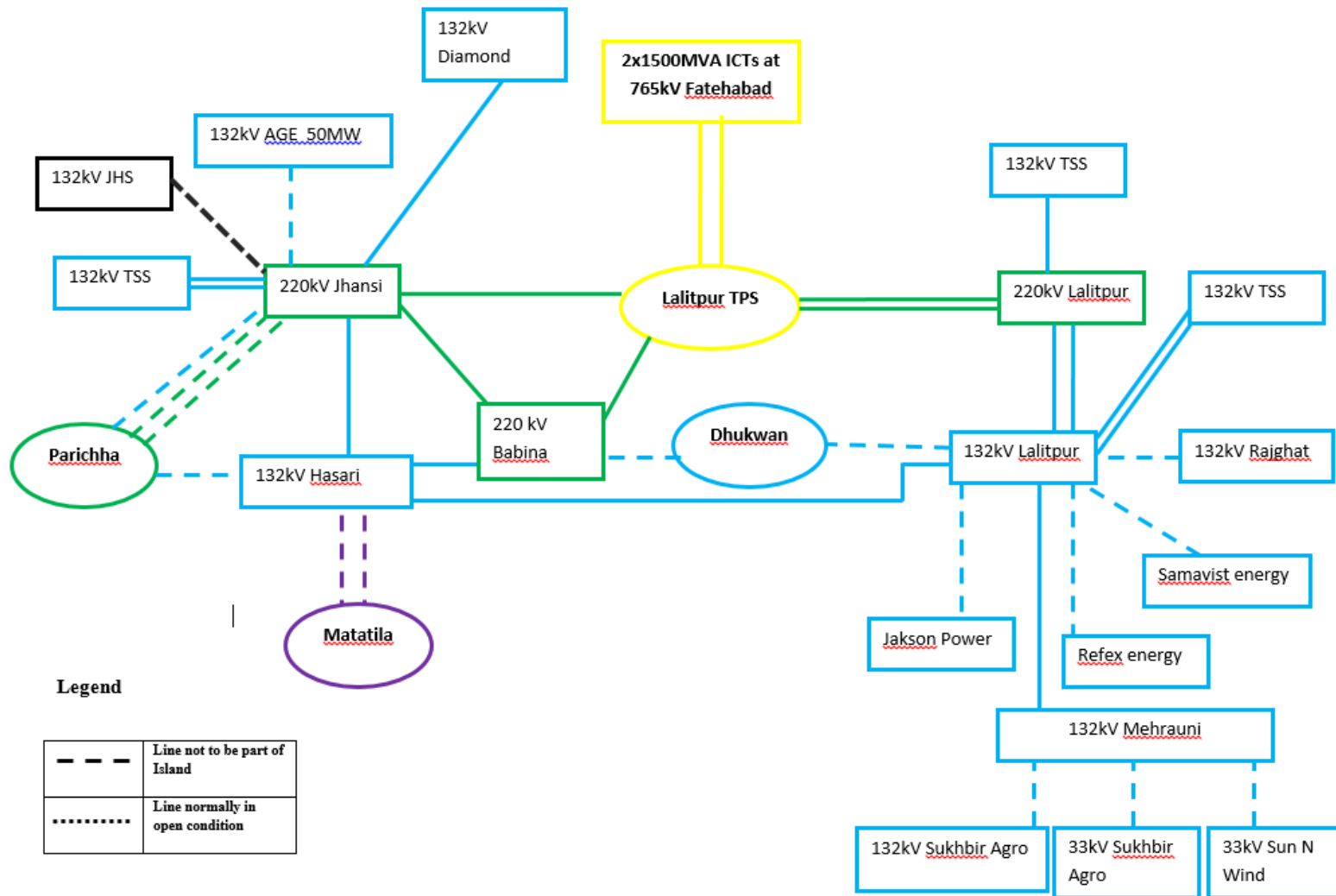

Fig. 1.2(b) Agra Island after Stage-I load shedding

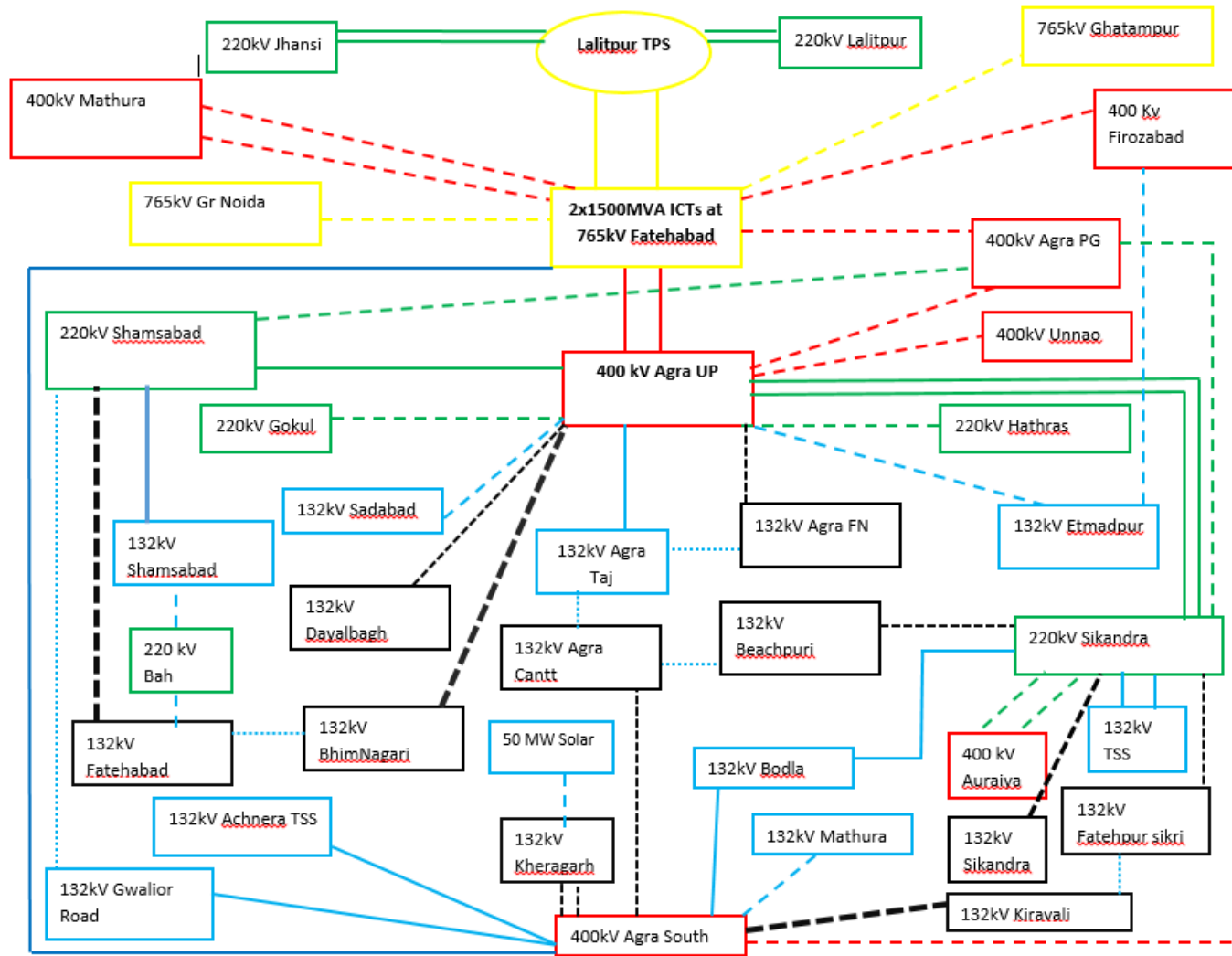

**Fig.1.3(a) Agra Island after Stage-II load shedding**

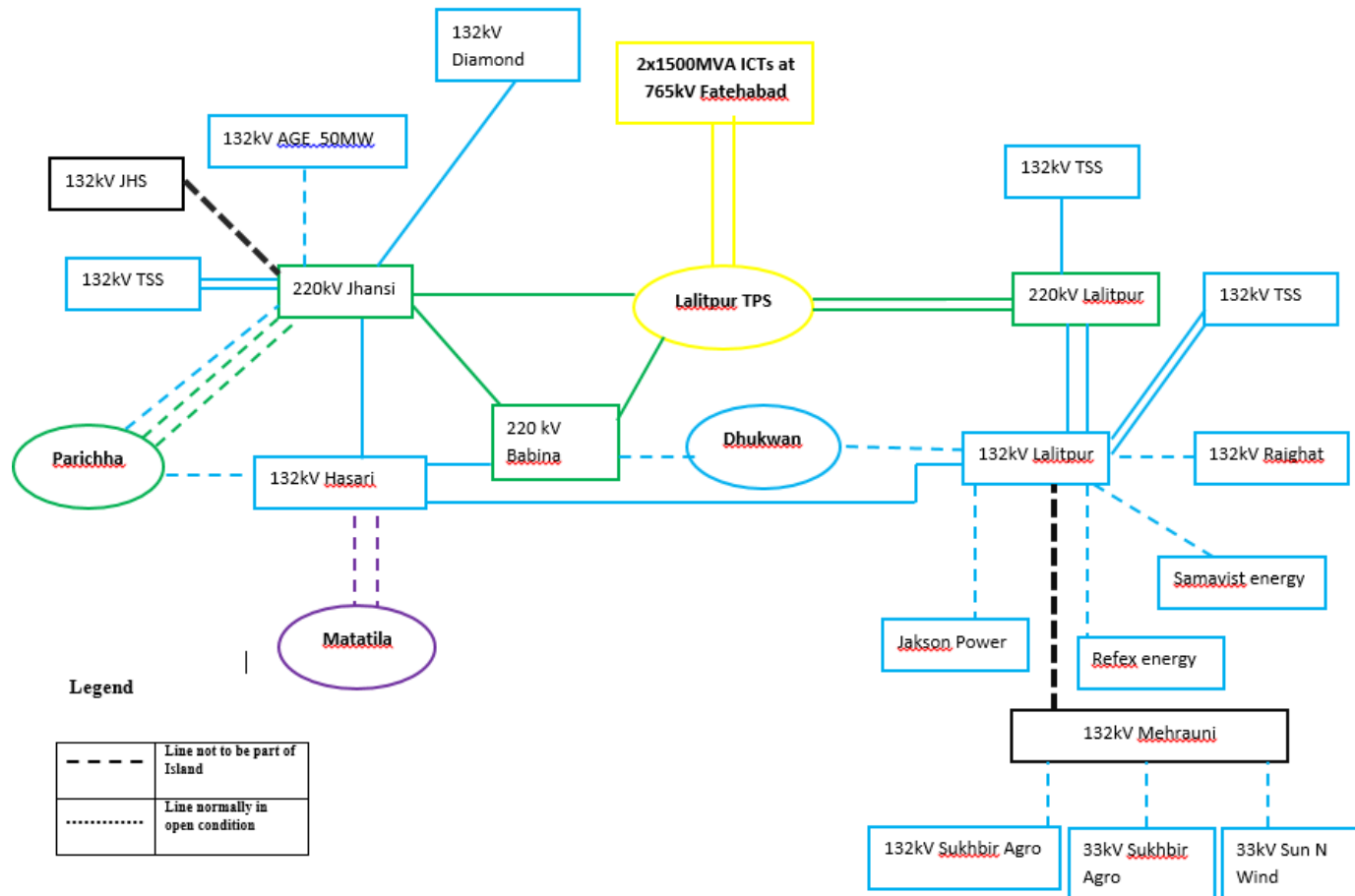

**Fig.1.3(b) Agra Island after Stage-II load shedding**





**Fig 1.4(a) Agra Island after Stage-III load shedding**



**Fig 1.4(b) Agra Island after Stage-III load shedding**

### 9.3.2 Over Frequency Load Reconnection (OFLC) Relay Settings

If the frequency increases beyond 50 Hz, the disconnected loads should be reconnected using auto-recloser. This is a small system with peak load of 1337 MW. However, the load shedding steps are 347, 189 and 148 MW which are 26%, 14% and 11%. Considering low Generation Ramp Rate in supercritical boiler plants, the generator may not be able to match the load and generation in small duration. Reconnection of loads in smaller steps helps in minimizing the difference between load and generation. Settings of the over frequency load reconnection (OFLC) are given below in Table VI.

**Table VI: OFLC Relay Settings and Loads Reconnected During Summer**

Frequency	Bus Name	Bus Number	Load Reconnected	Total Load Reconnected
$f > 50.5$	JHS2 33KV 33.000	153305	42	42
	JHS2 33KV 33.000	153305	45	87
	JHS2 33KV 33.000	153305	30	117
$f > 50.7$	BHIMNGR 33.000	153315	21.48	138.48
	BHIMNGR 33.000	153315	21.48	159.96
$f > 50.9$	KIRAWALI 33.000	153323	50	209.96
$f > 51.1$	SIKANDRA 33.000	153324	28.81	238.77
	SIKANDRA 33.000	153324	42.98	281.75
$f > 51.3$	FATEHBD 33.000	153331	35.9	317.65
	FATEHBD 33.000	153331	29.72	347.37
$f > 51.5$	FOUNDRY NGR 33.000	153317	78	425.37
	BEACHPURI 33.000	153327	39	464.37
$f > 51.7$ Or $f > 51.5$ Hz Continuously For 15s	AGHRA CANT 33.000	153321	72	536.37
$f > 52$ Or $f > 51.5$ Hz Continuously For 25s	DYALBAGH 33.000	153314	60	596.37
	MEHRAUNI 33.000	153312	33.6	629.97
	KHRGARH 33.000	153319	15.6	645.57
	KHRGARH 33.000	153319	14.8	660.37
	FATEHPUR SIK33.000	153328	24	684.37

It can be seen that Bus 153331 is reconnected at the last among the UFLS-Stage 1 buses. The reason is that the bus voltage is the lowest at this bus among all the UFLS-Stage 1 buses. Therefore, it is reconnected at the last.

### 9.3.3 Over Frequency Generator Tripping (OFGT) Relay Settings

The generators are tripped at 51.5 Hz with 30 seconds of delay and 52.5 Hz instantaneously. To avoid tripping of all generators at 52.5 Hz, load reconnection scheme has been proposed as mentioned above. However, if the islanding happens during off peak load period and initial generation is high, there may not be any load shedding and frequency may increase after islanding. Even if load shedding happens after islanding and load reconnection is done for over frequency, frequency may still rise to 52.5 Hz due to uncertainty in load reconnection, slow

response of prime mover controls. In that case, tripping of one generator may be required to avoid tripping of all three generators. Generation tripping scheme as explained below.

Over frequency tripping of generators can be done at a particular frequency or can be done early based on rate of change of frequency (ROCOF). The generator can be tripped at a frequency (e.g.  $f_{set1}=52$  Hz) based on a particular ROCOF setting. However, if the ROCOF is little less than the ROCOF setting and frequency continues to rise to 52.5 Hz, the generator won't be tripped. Therefore, ROCOF setting will be very critical in this case and may cause unnecessary tripping or not tripping even when required. Considering the inaccuracies in simulation models, the ROCOF setting may not be robust. On contrary, if we continuously monitor the frequency trajectory and predict that the frequency will cross 52.5 Hz within next  $T_{set}$  seconds, the generator can be tripped. Even for a conservative setting of  $T_{set}$ , the generator tripping may be delayed by a small duration, but it will certainly be tripped.

The relay settings are explained as follows: Suppose  $f$  is the frequency and  $\Delta f$  is the change in frequency from 0.2 second before.

- **triptime** = estimated time remaining for generator speed to cross 52.5Hz. It is obtained by linear extrapolating the frequency curve of the last 0.2 second. Frequency measurement should be filtered before use to avoid maloperation due to data anomaly.  $\Delta f$  must be positive (frequency is increasing), otherwise it will create maloperation during backswing of frequency. Therefore, if  $\Delta f < 0$ ,  $\Delta f = 0.0001$ . Using linear extrapolation, *triptime* is obtained as:

$$triptime = (52.5 - f)/(5 \times \Delta f)$$

- **fOFGT**: This is the frequency when all load reclosing will be completed. If  $f_{nadir}$  is the nadir frequency measured at the generator bus,  $f_{OFGT}$  is set as per the Table VII.

**Table VII: fOFGT as a function of fnadir measured at the generator bus.**

No UFLS	If $f_{nadir} > 47.65$ fOFGT = 51.0
UFLS-Stage 1 happened	If $f_{nadir} < 47.65$ and $f_{nadir} > 47.35$ : fOFGT = 51.3
UFLS-Stage 2 happened	If $f_{nadir} < 47.35$ and $f_{nadir} > 47.15$ : fOFGT = 51.7
UFLS-Stage 3 happened	If $f_{nadir} < 47.15$ fOFGT = 52.0

*It is to be noted that 0.05Hz measurement error margin or difference between frequency measured at generating plant and the load buses are considered.*

- Condition for OFGT:

$$(triptime < 0.5 \text{ and } f > (0.2 + f_{OFGT})) \text{ or } f > 52.45$$

Estimated time for generator tripping should be less than 0.5second. It has been found from the simulation test case when initial generation is maximum and load in the island is minimum that a generator must be tripped at least 0.3s before reaching 52.5 Hz to avoid tripping of all generators. In this case, the generator acceleration after islanding is maximum and a generator needs to be tripped early to avoid tripping of all generators due to over frequency. It was found out that if the estimated time remaining for the generators to reach 52.5 Hz is higher than 0.3 second and a generator is tripped, the speed of the other two generators would not cross 52.5

Hz. For any other cases, the acceleration of the generators after islanding will be lesser and hence a generator can be tripped if the generator speed is expected to reach 52.5 Hz in lesser than 0.3s. Considering relay-breaker operation time of 0.1s and a safety margin of 0.1s, a threshold of 0.5s was selected.

Considering the delay in breaker in load reconnection, 0.2 Hz is added to fOFGT. If the frequency measured at generator bus is lesser than 47.65 Hz and higher than 47.35 Hz, there is a possibility of UFLS-Stage-1 at the load buses. Though the last stage of load reconnection for UFLS-Stage-1 buses (i.e. FATEHBD, 153331) is initiated at 51.3 Hz, actual reconnection may take some time due to inherent delays in breakers. Therefore, 0.2 Hz is added with 51.3 Hz to set the frequency threshold for generation tripping at 51.5 Hz.

### **9.3.4 Low Power Generation Tripping (LPGT)**

The plant operator should decide whether to trip a generator manually or automatically if power output is below minimum generation.

## **9.4 Validation of Relay Settings Using Simulation**

Settings of the relay was decided based on extensive simulation studies for various loading conditions and initial generation. A total 18 test cases are presented below to demonstrate the effectiveness of the relay settings in stabilizing the island frequency. Three loading conditions, e.g. peak summer load of 1337 MW, average load of 950 MW and off peak winter load of 840 MW were considered. Number of generators connected to the grid just before islanding was considered either three or two. Initial generation for each generator was considered either 610 MW (peak output), 460 MW (average output), and 330 MW (minimum output). Considering all possible combinations, a total 18 case studies are presented below.

### **9.4.1 Case 1: Peak Load-Three Generators-Peak Initial Generation**

This case study presents simulation results for islanding event during the following condition:

Number of Generators ON before Islanding = 3

Initial Power Output of Generators =  $610 \times 3 = 1830$  MW (Peak Generation)

Load in the Island = 1337 MW (Peak Load during Summer)

**Description:** Frequency fall was created by tripping a large generator in the external area at 1s, which results in increase in electrical power just after the generator tripping event. As mechanical power is already at maximum before frequency fall, it remains same during the frequency fall. Islanding happens at 47.9 Hz. As the mechanical power at the instant of islanding is higher than the post islanding load, frequency rises after islanding as shown in Fig.1. Governor action is able to regulate the frequency after islanding without any load shedding or generator tripping.

**Conclusion:** No load shedding or generation tripping is required when islanding happens during summer peak load and three generators connected to grid with peak generation

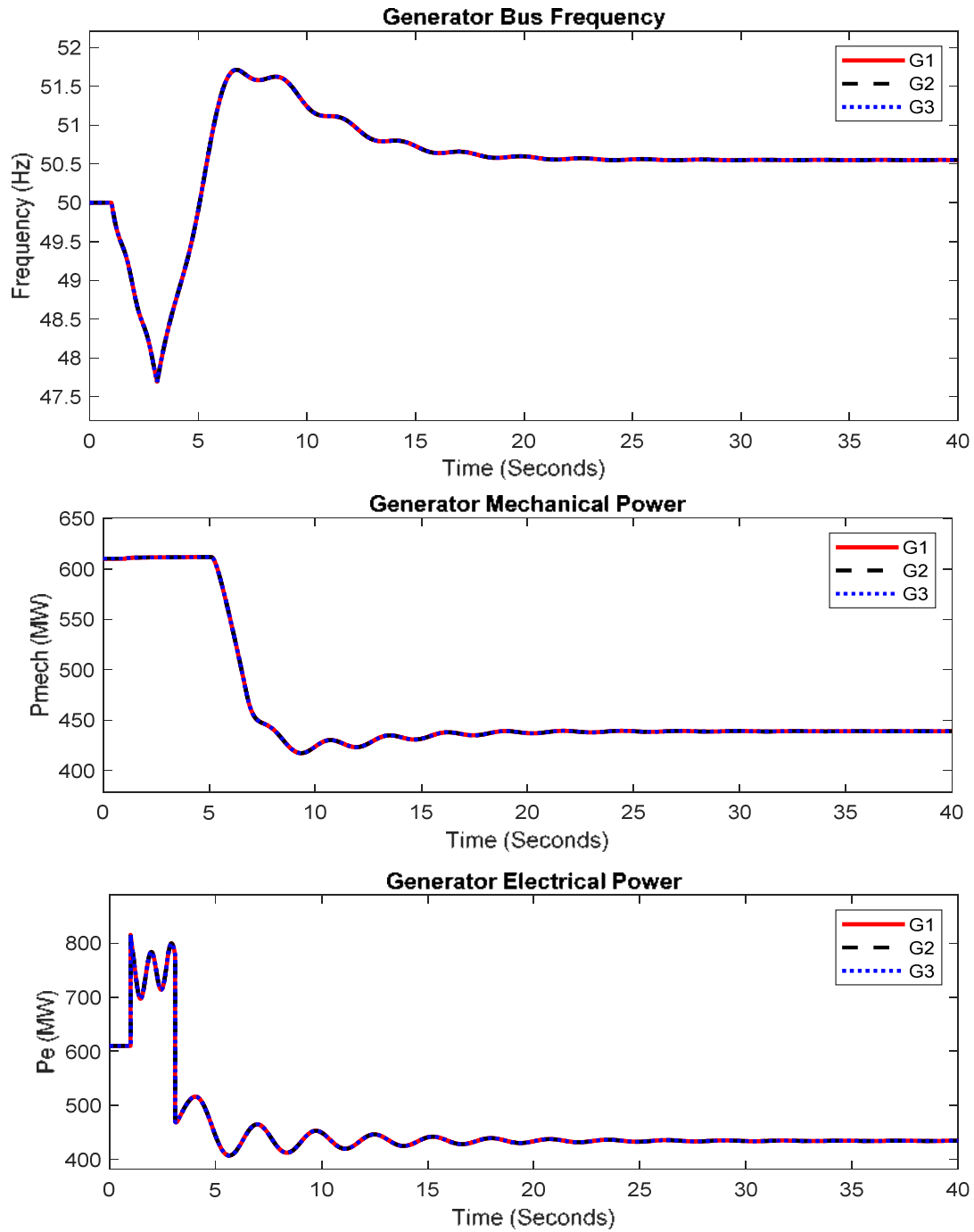

*Fig.1: Variations in frequency, mechanical power and electrical power in case of islanding during peak load, peak initial generation with three generators connected to the grid.*

#### 9.4.2 Case 2: Peak Load-Three Generators - Average Initial Generator

This case study presents simulation results for islanding event during the following condition:

Number of Generators ON before Islanding = 3

Initial Power Output of Generators =  $460 \times 3 = 1380$  MW (Average Generation)

Load in the Island = 1337 MW (Peak Load during Summer)

**Description:** Frequency fall was created by tripping a large generator in the external area at 1s, which results in increase in electrical power just after the generator tripping event. Mechanical power increases during the frequency fall due to droop control in the governor. Islanding happens at 47.9 Hz. As the mechanical power at the time of islanding is higher than the post islanding load, frequency rises after islanding. Governor action is able to regulate the frequency after islanding without any load shedding or generator tripping, as shown in Fig. 2.

**Conclusion:** No load shedding or generation tripping is required when islanding happens during summer peak load and three generators connected to grid with average initial generation.

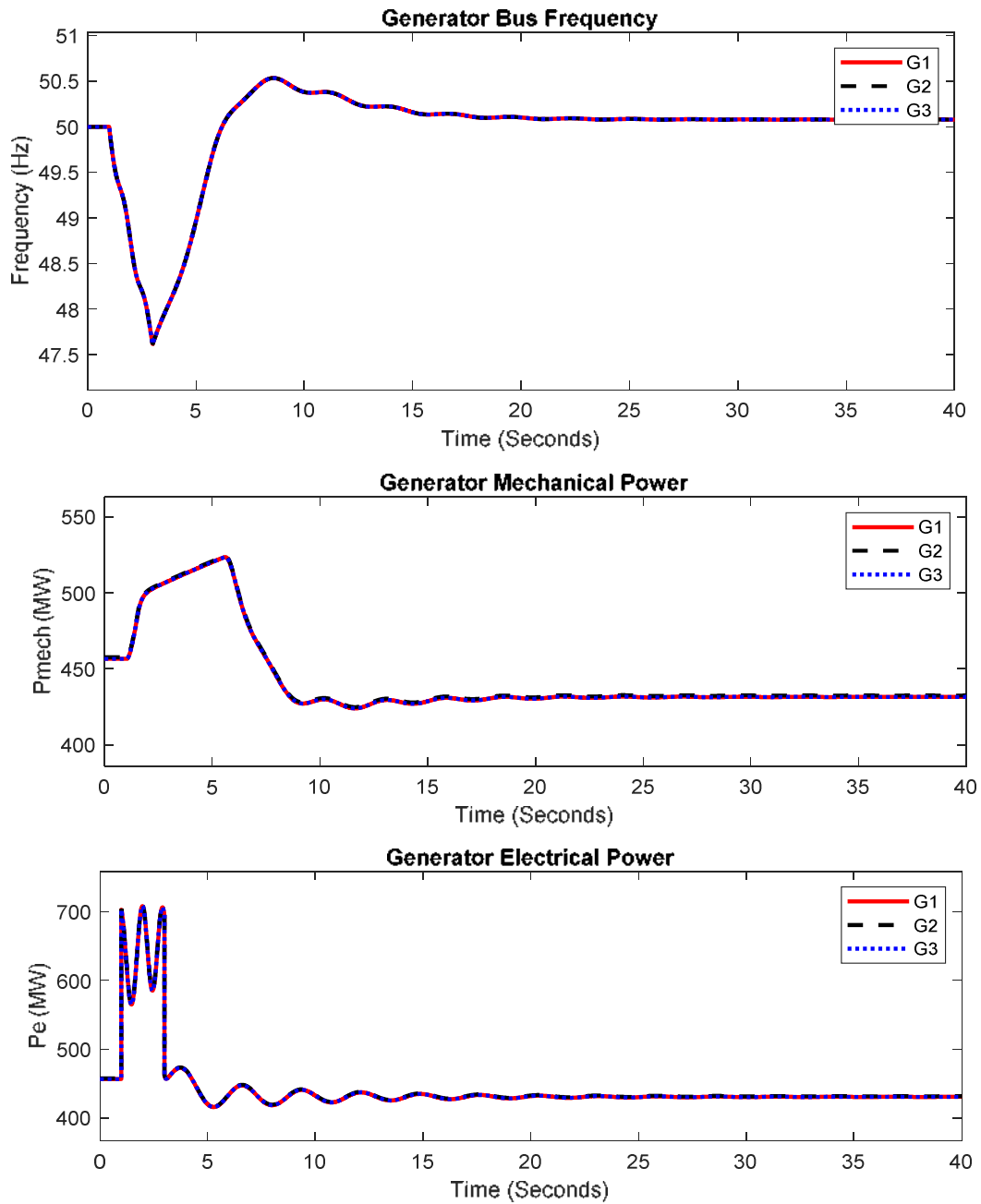

*Fig.2: Variations in frequency, mechanical power and electrical power in case of islanding during peak load, average initial generation with three generators connected to the grid.*



### 9.4.3 Case 3: Peak Load-Three Generator-Minimum Initial Generation

This case study presents simulation results for islanding event during the following condition:

Number of Generators ON before Islanding = 3

Initial Power Output of Generators =  $330 \times 3 = 990$  MW (Minimum Generation)

Load in the Island = 1337 MW (Peak Load during Summer)

**Description:** Frequency fall was created by tripping a large generator in the external area at 1s, which results in increase in electrical power just after the generator tripping event. Islanding happens at 47.9 Hz. Though the initial mechanical power is less, it increases during the frequency fall due to droop control in the governor. It increases higher than the post islanding load and hence, frequency rises after islanding. Governor action is able to regulate the frequency after islanding without any load shedding or generator tripping as shown in Fig.3.

**Conclusion:** No load shedding or generation tripping is required when islanding happens during summer peak load and three generators connected to grid even with minimum generation.

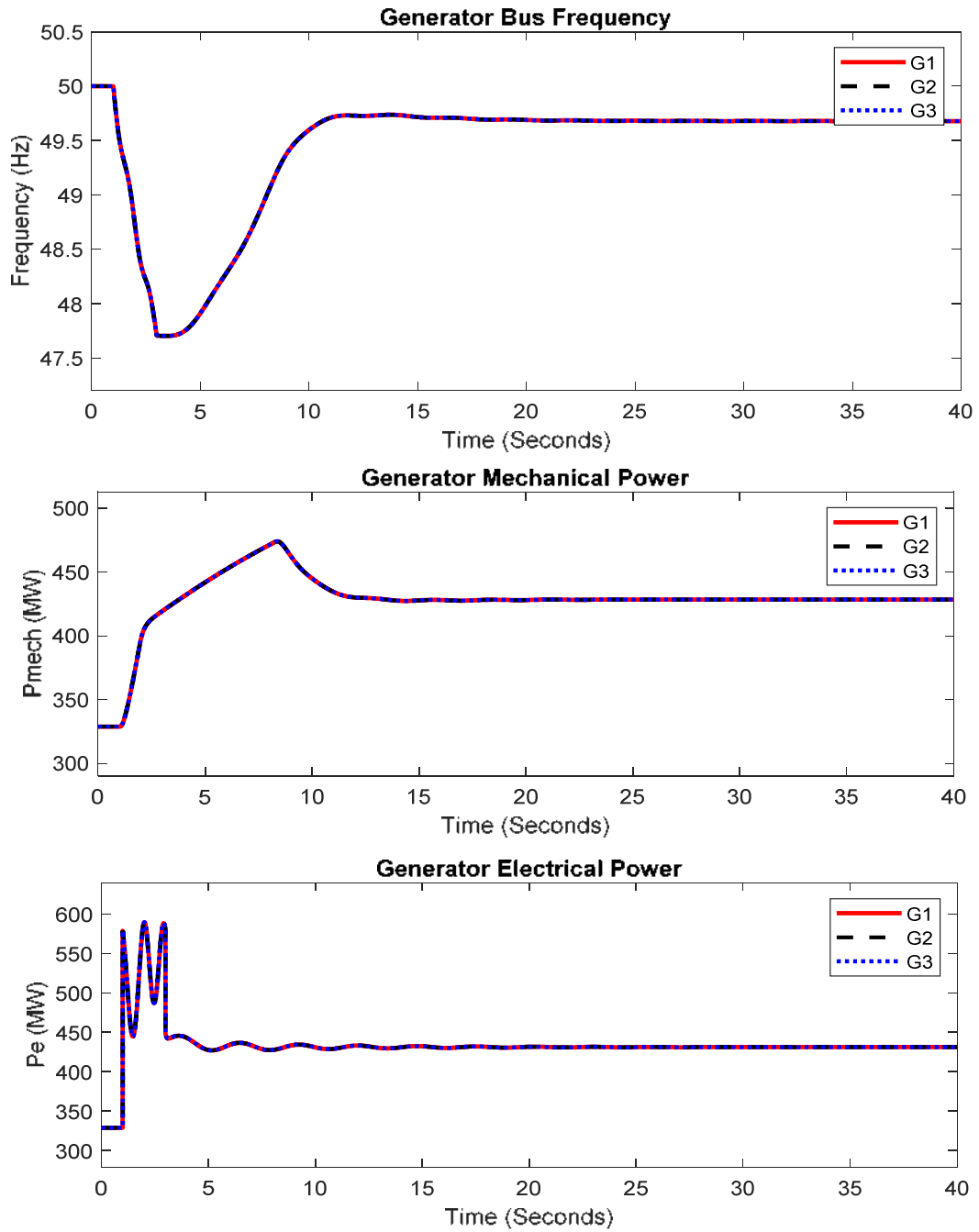

Fig.3: Variations in frequency, mechanical power and electrical power in case of islanding during peak load, three generators connected to the grid with minimum initial generation.

#### 9.4.4 Case 4: Average Load-Three Generator-Peak Initial Generation

This case study presents simulation results for islanding event during the following condition:

Number of Generators ON before Islanding = 3

Initial Power Output of Generators  $\sim 610 \times 3 = 1830$  MW (Peak Generation)

Load in the Island = 950 MW (Average Load)

**Description:** A large generator in the external area was tripped at 1s, which results in increase in electrical power of the Lalitpur generators and system wide frequency fall just after the generator tripping event. As the initial mechanical power is maximum, it remains same during the frequency fall. Islanding happens at 47.9 Hz. As the mechanical power (1830 MW) is much higher than the post islanding load (950 MW), frequency rises after islanding very fast. A generator is tripped when frequency reaches 51.7 Hz which increases electrical power of the other two generators and reduces acceleration. Thus, tripping of all three generators is avoided as shown in Fig. 4. However, if a generator is not tripped, speed of all the generators will reach 54 Hz as shown in Fig. 5. As the generators are tripped at 52.5 Hz instantaneously by the existing protection schemes of the plant, all three generators will be disconnected if a generator is not tripped early.

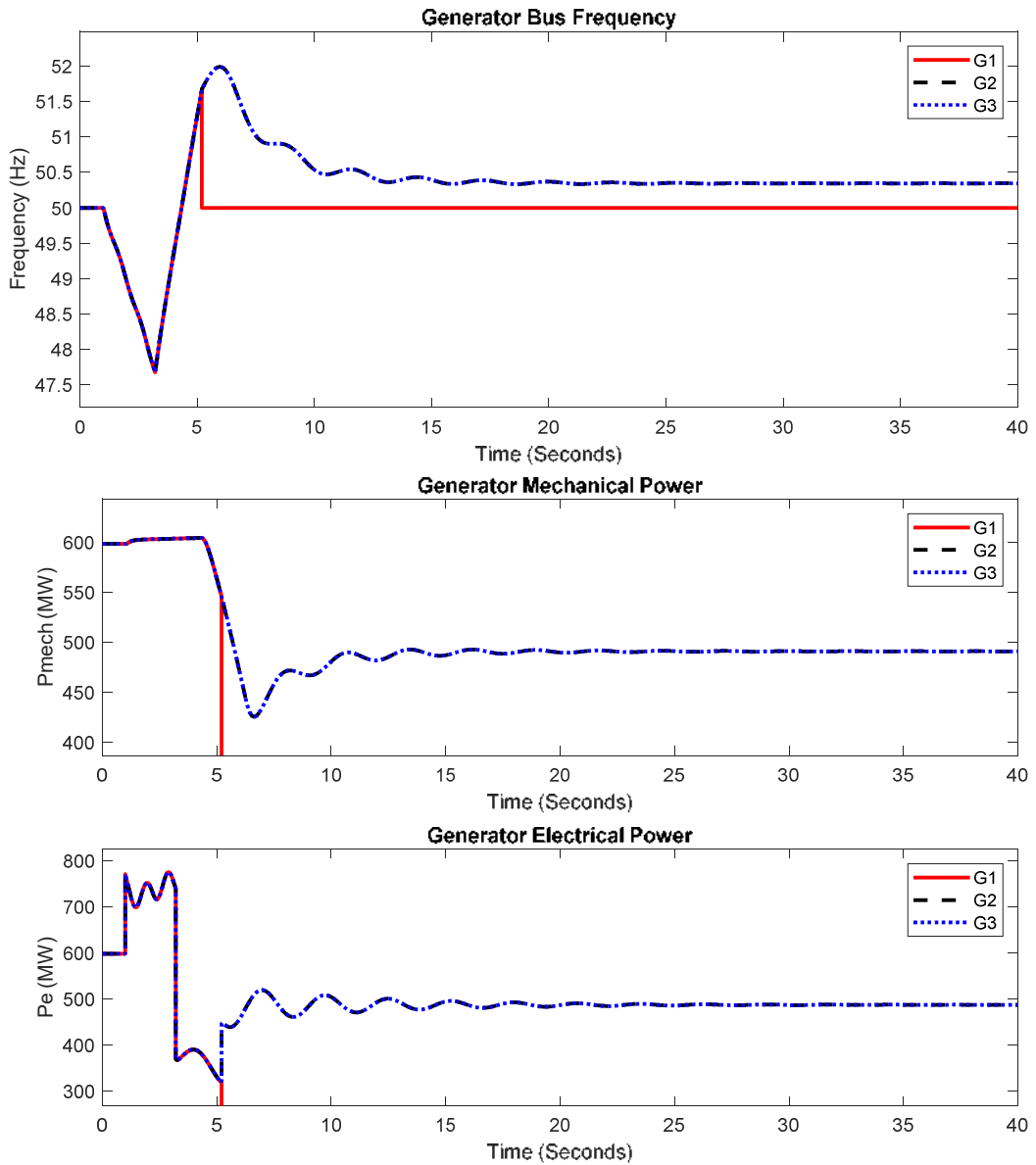

Fig.4: Variations in frequency, mechanical power and electrical power in case of islanding during average load, peak initial generation with three generators connected to the grid. A generator is tripped early to avoid tripping of all the generators due to over-speed.

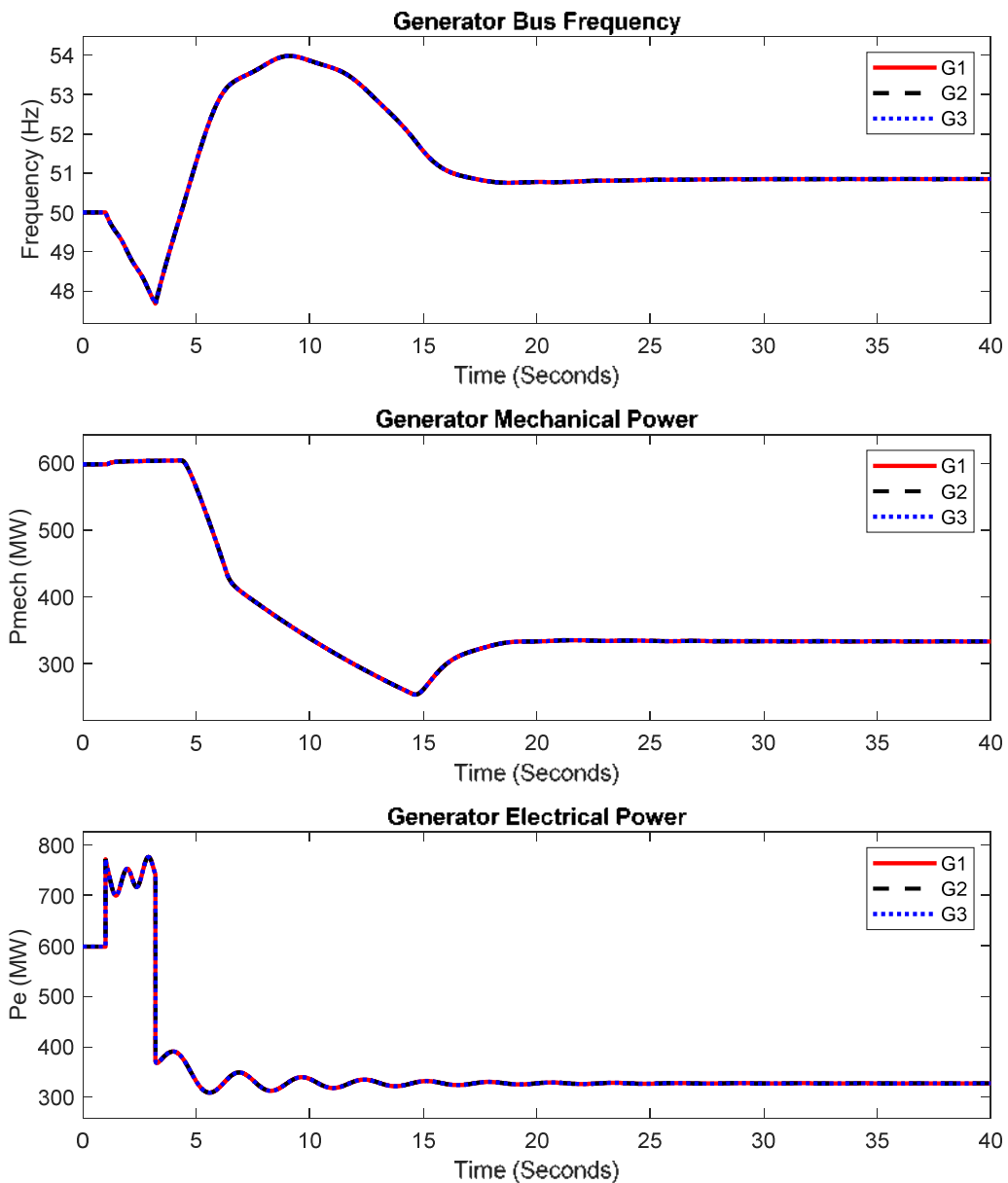

Fig.5: Variations in frequency, mechanical power and electrical power in case of islanding during average load, peak initial generation with three generators connected to the grid. No generator is tripped as part control action to restrict the island frequency crossing 52.5 Hz.

**Conclusion:** A generator is tripped early to stabilize the frequency in the island and avoid tripping of all generators in case of islanding event during average load and peak initial generation with three generators connected to the grid.

#### 9.4.5 Case 5: Average Load-Three Generators-Average Initial Generation

This case study presents simulation results for islanding event during the following condition:

Number of Generators ON before Islanding = 3

Initial Power Output of Generators =  $460 \times 3 = 1380$  MW (Average Generation)

Load in the Island = 950 MW (Average Load)

**Description:** Frequency fall was created by tripping a large generator in the external area at 1s, which results in increase in electrical power just after the generator tripping event. Mechanical power increases during the frequency fall due to droop control in the governor. Islanding happens at 47.9 Hz. As the mechanical power is higher than the post islanding load, frequency rises after islanding. However, governor action is able to regulate the frequency after islanding without any load shedding or generator tripping as shown in Fig.6. It is to be noted that the generator speed reaches around 52.2 Hz, and the OFGT relay is able to predict that generator speed won't cross 52.5 Hz. Hence, no generator has been tripped.

**Conclusion:** No load shedding or generation tripping is required to regulate the post islanding frequency in the island. However, generator output is lesser than minimum power, one generator should be tripped automatically/by the operator to have safe and efficient operation of the plant.

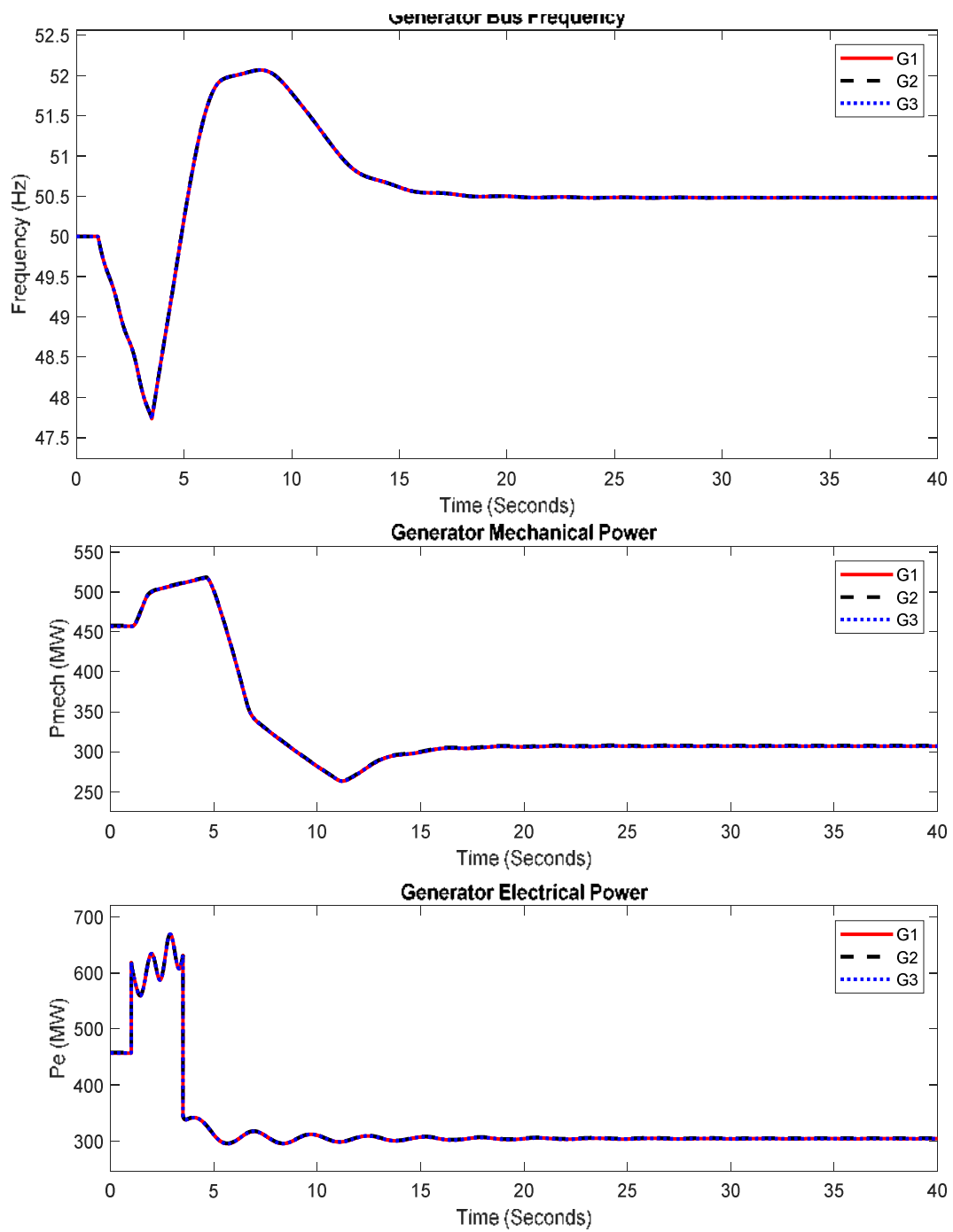

Fig.6: Variations in frequency, mechanical power and electrical power in case of islanding during average load, average initial generation with three generators connected to the grid.

#### 9.4.6 Case 6: Average Load-Three Generators-Minimum Initial Generation

This case study presents simulation results for islanding event during the following condition:  
Number of Generators ON before Islanding = 3

Initial Power Output of Generators =  $330 \times 3 = 990$  MW (Minimum Initial Generation)

Load in the Island = 950 MW (Average Load)

**Description:** Frequency fall was created by tripping a large generator in the external area at 1s, which results in increase in electrical power just after the generator tripping event. Mechanical power increases during the frequency fall due to droop control in the governor. Islanding happens at 47.9 Hz. As the mechanical power is higher than the post islanding load, frequency rises after islanding. However, governor action is able to regulate the frequency after islanding without any load shedding or generator tripping as shown in Fig.7.

**Conclusion:** No load shedding or generation tripping is required to regulate the frequency in the island. However, generator output is marginally lesser than the minimum power, one generator should be tripped automatically/by the operator to have safe and efficient operation of the plant.

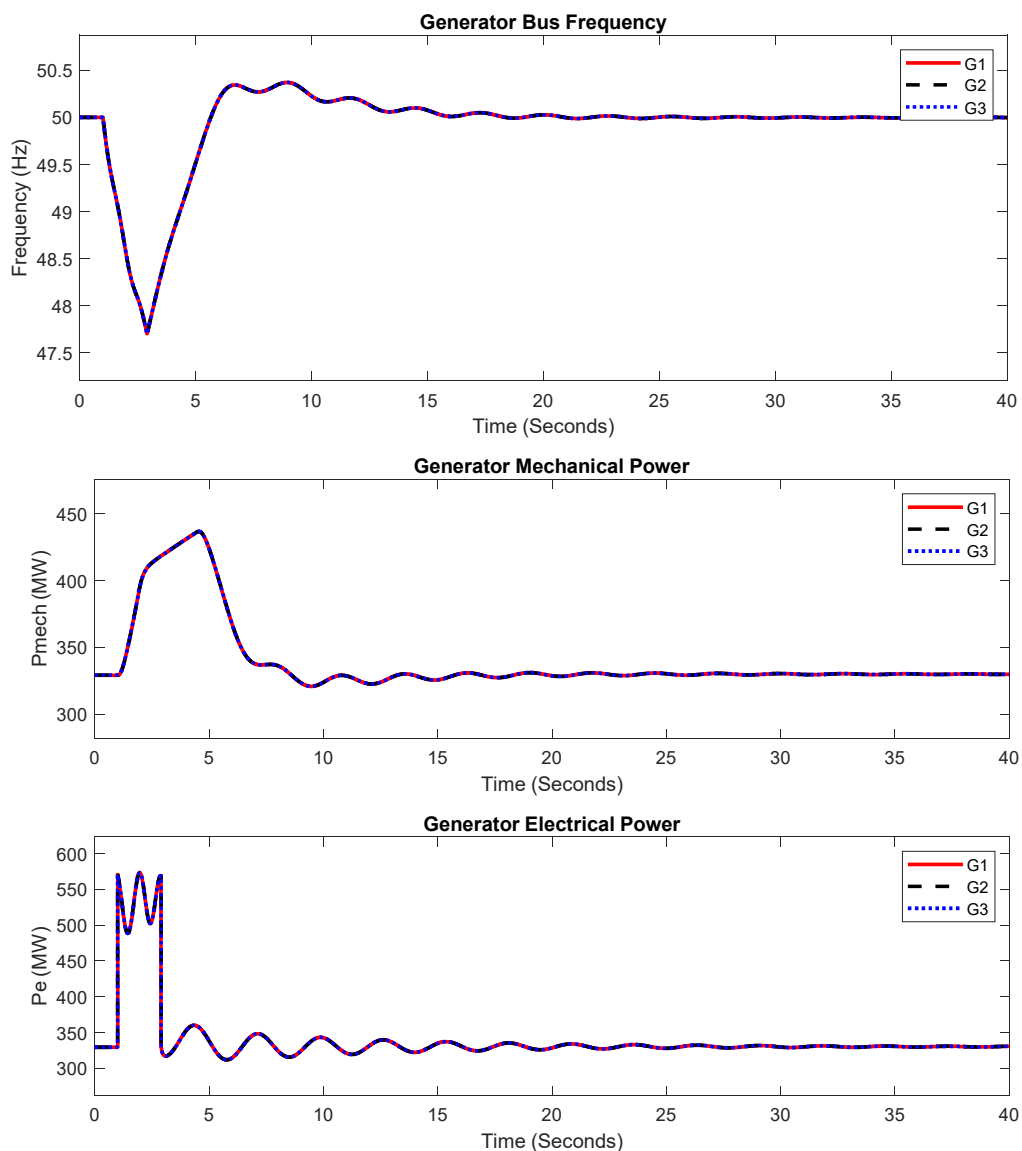

Fig.7: Variations in frequency, mechanical power and electrical power in case of islanding during average load, minimum initial generation with three generators connected to the grid.



#### **9.4.7 Case 7: Minimum Load-Three Generators-Peak Initial Generation**

This case study presents simulation results for islanding event during the following condition:  
Number of Generators ON before Islanding = 3

Initial Power Output of Generators =  $610 \times 3 = 1830$  MW (Peak Generation)

Load in the Island = 870 MW (minimum load during winter)

Description: A large generator in the external area was tripped at 1s, which results in increase in electrical power of the Lalitpur generators and system wide frequency fall just after the generator tripping event. As the mechanical power is already at maximum before islanding, it remains same during the frequency fall. Islanding happens at 47.9 Hz. As the mechanical power is much higher than the post islanding load, frequency rises after islanding very fast. A generator is tripped at 51.5 Hz to avoid tripping of all three generators as shown in Fig. 8. The simulation results for the same generator tripping and islanding event but without generator tripping show that the generator speed will increase up to 54 Hz as shown in Fig. 9. As the generators are tripped at 52.5 Hz instantaneously, all three generators would be disconnected if a generator was not tripped early.

Conclusion: A generator is tripped early to stabilize the frequency in the island in case of islanding event during minimum load, peak initial generation with three generators connected to the grid.

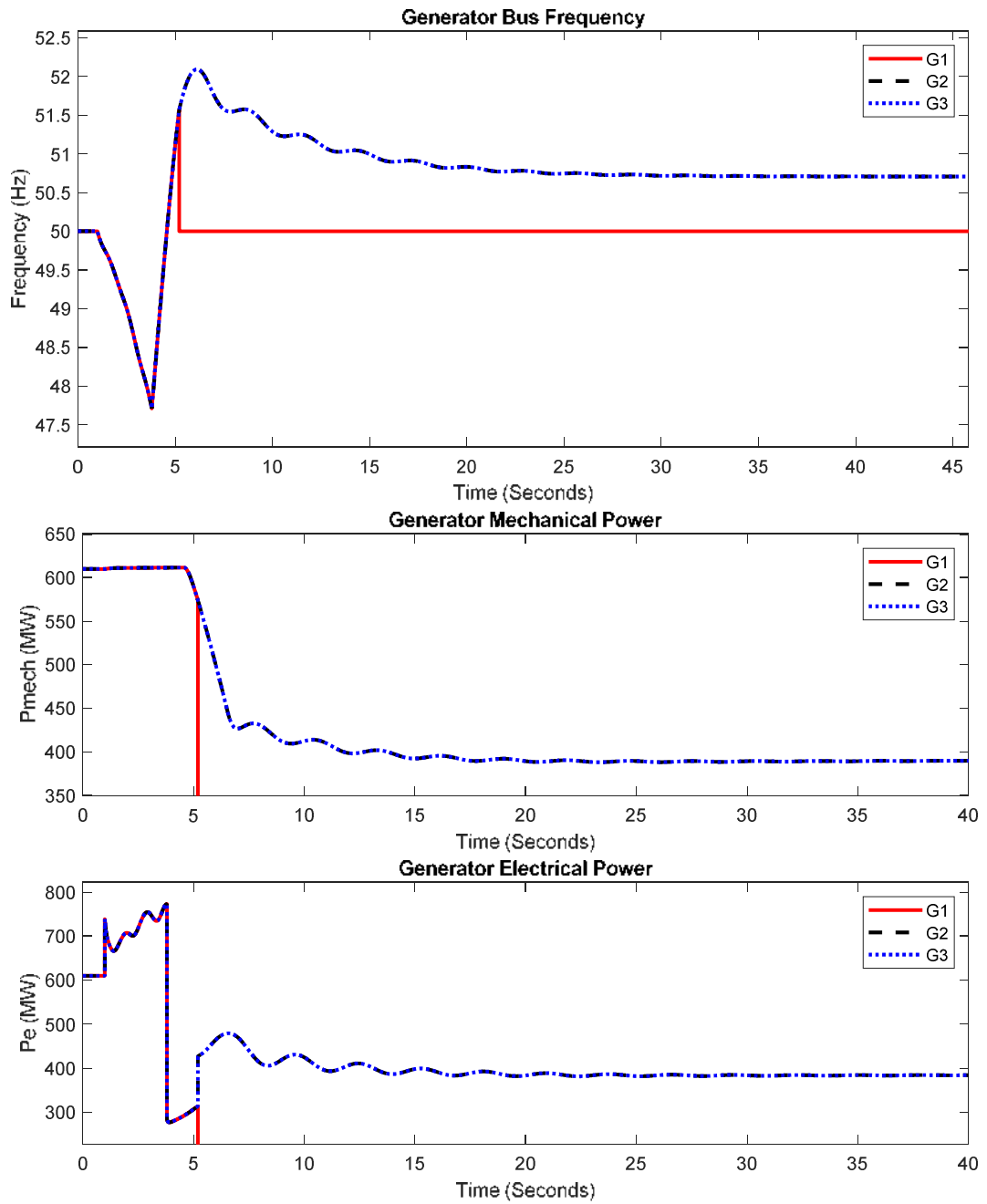

Fig.8: Variations in frequency, mechanical power and electrical power in case of islanding during minimum load, peak initial generation with three generators connected to the grid. A generator is tripped early to avoid tripping of all generators at 52.5 Hz.

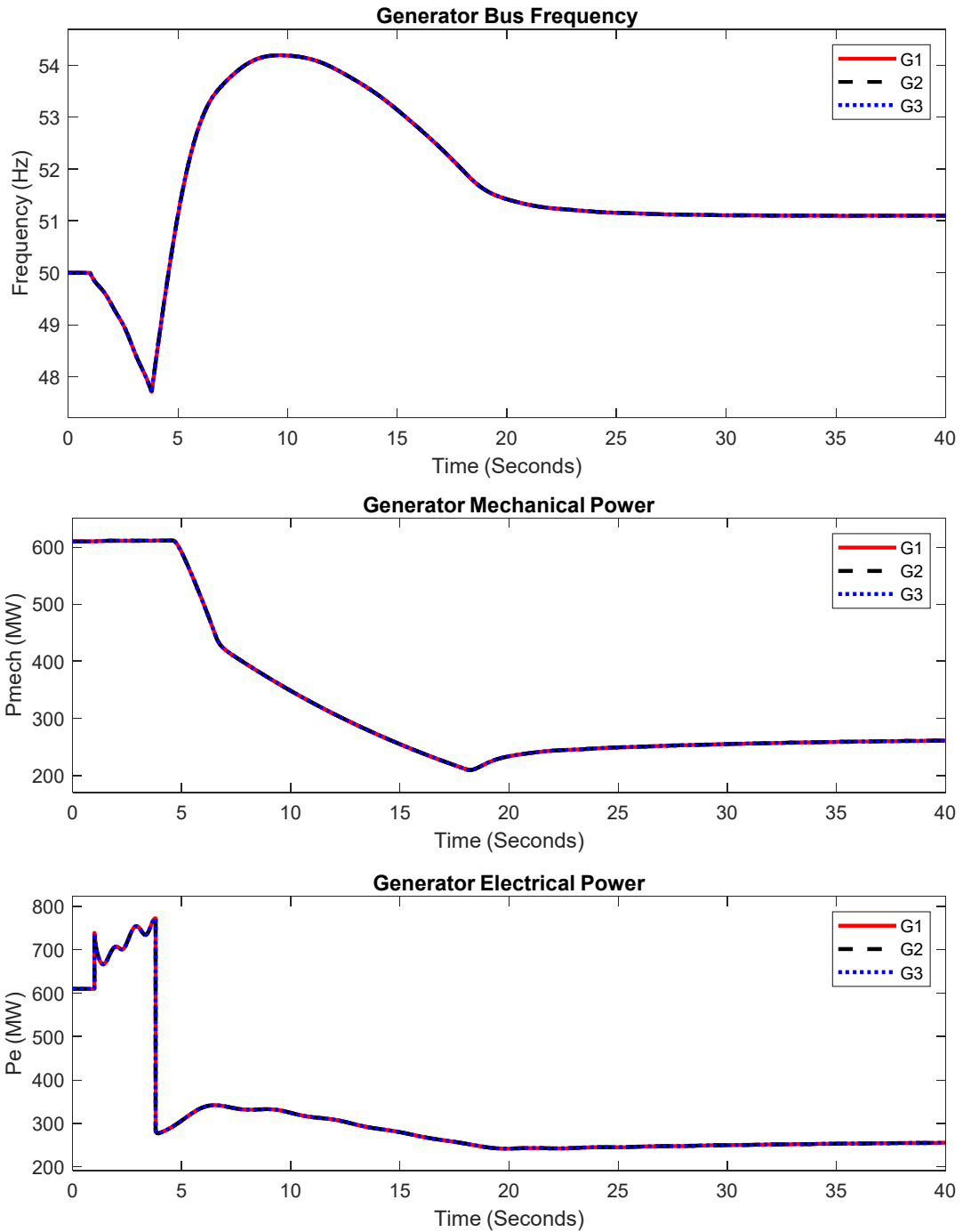

Fig.9: Variations in frequency, mechanical power and electrical power in case of islanding during minimum load, peak initial generation with three generators connected to the grid. No generator was tripped early by the OFGT relay. All generators will be tripped by the default protection schemes of the plant as the generator speed reaches 52.5 Hz.

### 9.4.8 Case 8: Minimum Load-Three Generators-Average Initial Generation

This case study presents simulation results for islanding event during the following condition:  
Number of Generators ON before Islanding = 3

Initial Power Output of Generators =  $460 \times 3 = 1380$  MW (Average Generation)

Load in the Island = 870 MW (Minimum Load)

**Description:** Frequency fall was created by tripping a large generator in the external area at 1s, which results in increase in electrical power just after the generator tripping event. Mechanical power increases during the frequency fall due to droop control in the governor. Islanding happens at 47.9 Hz. As the mechanical power is higher than the post islanding load, frequency rises after islanding. However, governor action is able to regulate the frequency after islanding without any load shedding or generator tripping as shown in Fig. 10. It is to be noted that the generator speed reaches around 52.4 Hz, and the OFGT relay is able to predict that generator speed won't cross 52.5 Hz. Hence, no generator has been tripped unnecessarily.

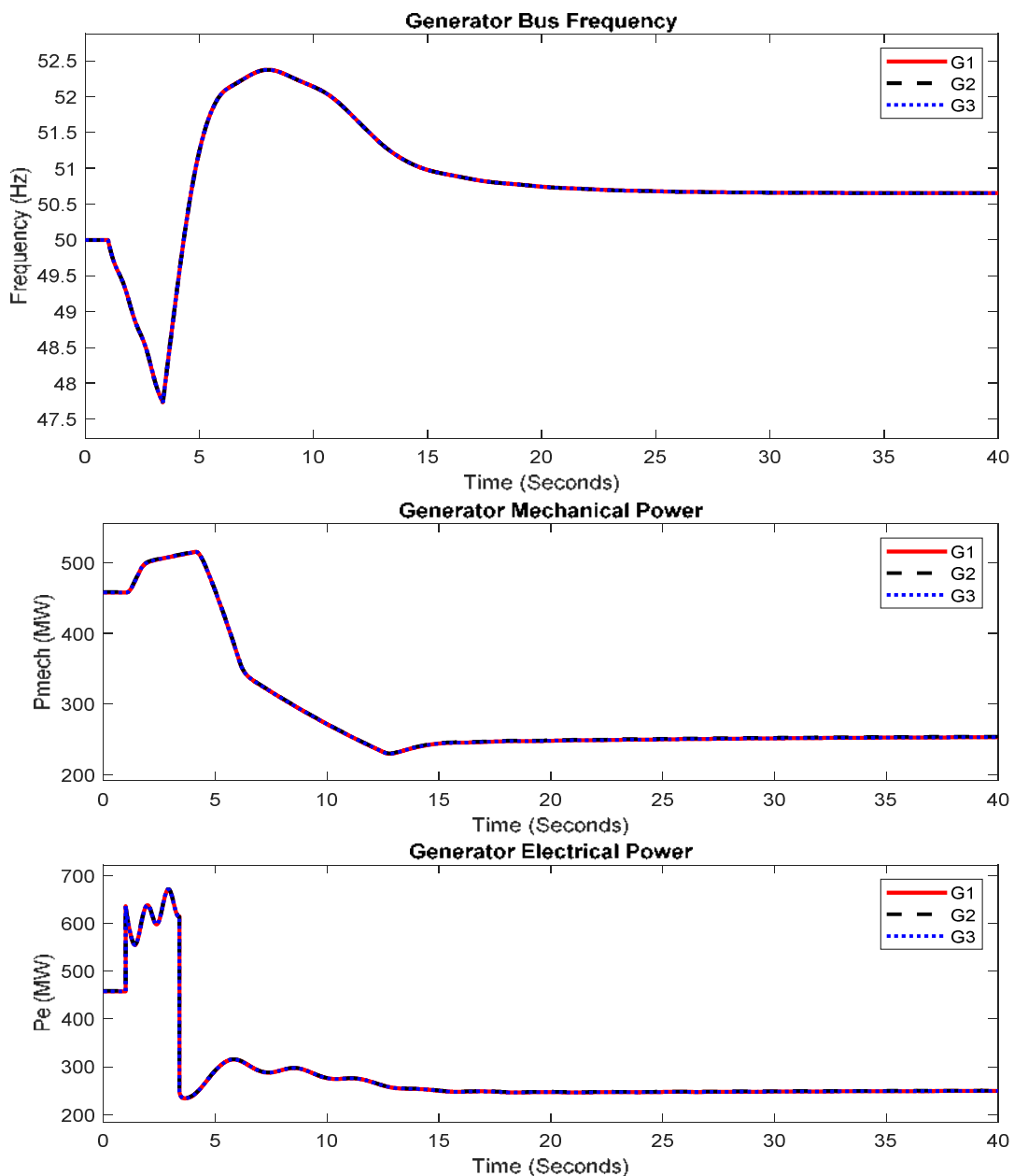

Fig.10: Variations in frequency, mechanical power and electrical power in case of islanding during minimum load, average initial generation with three generators connected to the grid.

It can be seen from Fig.11 that ROCOF continues to reduce as the frequency increases and the frequency curve becomes more and more flat. Therefore, estimated time to reach 52.5 Hz is still high though the frequency is very close to 52.5 Hz. Hence, unnecessary tripping of generator is avoided. However, if each generator is protected by separate relay (over speed tripping at 52.5 Hz), we should consider the error/noise in frequency measurements. Therefore, if frequency reaches 52.45 Hz, a generator should be tripped even if the estimated triptime is higher than the threshold i.e. 0.5s.

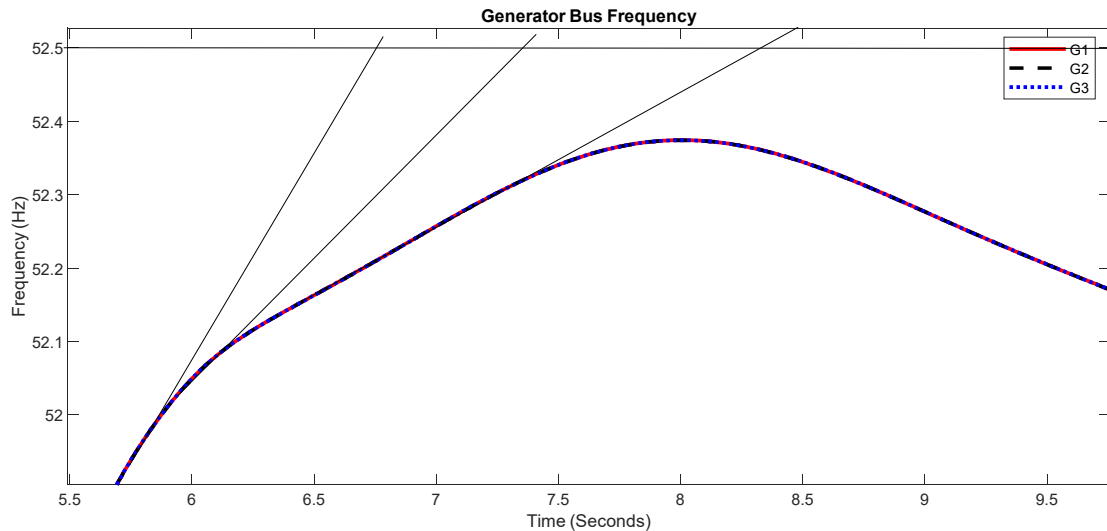

Fig.11: Part of the frequency response is zoomed to show the variation in slope and trip time in case of islanding during minimum load, average initial generation with three generators connected to the grid.

**Conclusion:** No load shedding or generation tripping is required to stabilize the island frequency. However, generator output is lesser than the minimum power, one generator should be tripped automatically/by the operator to have safe and efficient operation of the plant.

#### 9.4.9 Case 9: Minimum Load-Three Generators-Minimum Initial Generation

This case study presents simulation results for islanding event during the following condition:  
Number of Generators ON before Islanding = 3

Initial Power Output of Generators =  $330 \times 3 = 990$  MW (Low Generation)

Load in the Island = 870 MW (Minimum Load)

**Description:** Frequency fall was created by tripping a large generator in the external area at 1s, which results in increase in electrical power just after the generator tripping event. Mechanical power increases during the frequency fall due to droop control in the governor. Islanding happens at 47.9 Hz. As the mechanical power at the time of islanding is higher than the load in the island, frequency rises after islanding. However, governor action is able to regulate the frequency after islanding without any load shedding or generator tripping as shown in Fig. 12.

**Conclusion:** No load shedding or generation tripping is required. However, generator output is lesser than the minimum power, one generator should be tripped automatically/by the operator to have safe and efficient operation of the plant.

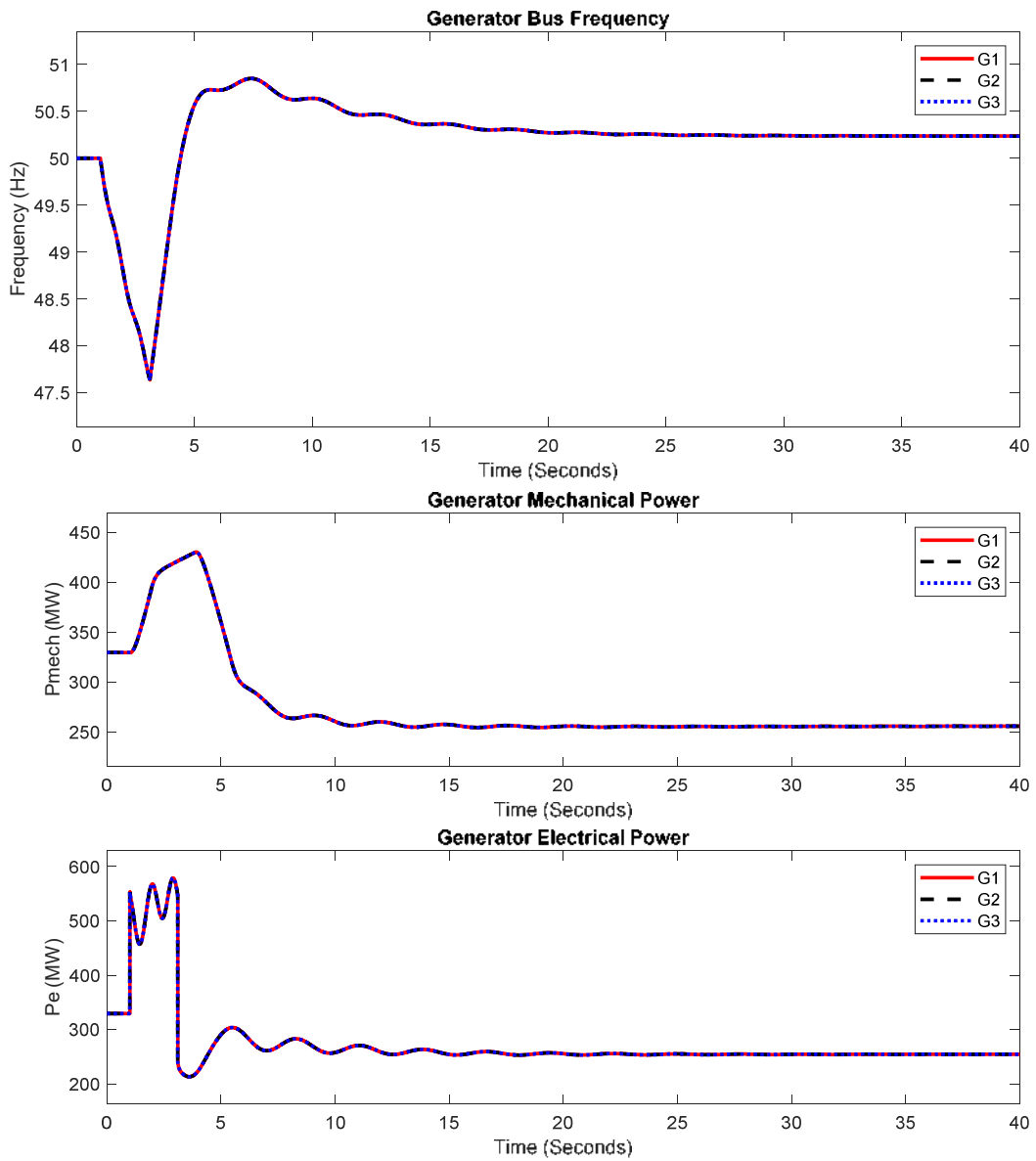

Fig.12: Variations in frequency, mechanical power and electrical power in case of islanding during minimum load, minimum initial generation with three generators connected to the grid.

#### 9.4.10 Case 10: Peak Load-Two Generators-Peak Initial Generation

This case study presents simulation results for islanding event during the following condition:  
Number of Generators ON before Islanding = 2

Initial Power Output of Generators =  $610 \times 3 = 1220$  MW (Peak Generation)

Load in the Island = 1337 MW (Peak load)

**Description:** A large generator in the external area was tripped at 1s, which results in increase in electrical power of the Lalitpur generators and system wide frequency fall just after the generator tripping event. As the mechanical power is already at maximum before frequency fall, it remains same during the frequency fall. Islanding happens at 47.9 Hz. Just after islanding, the voltage reduces drastically due to increased load. As the loads have been modelled as impedance loads, power consumption by the loads reduces. As the total electrical load is less than total mechanical power, frequency increases initially after the islanding. As the AVR action improves the voltage, power consumption by the loads also increases. Total electrical load becomes higher than the mechanical power. Therefore, frequency begins to fall. As the frequency falls below 47.6 Hz, UFLS-stage 1 occurs and buses 153305, 153315, 153323, 153324, 153331 are disconnected. Frequency is restored due to reduction in electrical loads. As frequency continues to increase beyond 50.5 Hz, loads at bus 153305 and 153315 are reconnected. It can be seen from Fig. 13 that load reconnection helps in reducing the difference between post island and pre island steady state power output of generators.

A portion of the power curve is zoomed in Fig. 14 to show the UFLS stage-1 during frequency fall and load reconnections during over frequency.

As shown in Fig. 15, if load reconnection is not done, peak frequency is higher and the difference between steady state pre islanding and post islanding power output of generators is also higher.

Without any control action/load shedding & load reconnection: If UFLS and OFLR relays are not activated, the frequency deviation will be too much as shown in Fig. 16. As the loads are impedance loads and the post islanding bus voltages are less, power consumption by the loads is much lesser than 1337 MW. Two generators are able to supply the load. However, if the load is little higher than 1220 MW even after voltage drop, two generators would not be able to supply and the frequency will collapse.

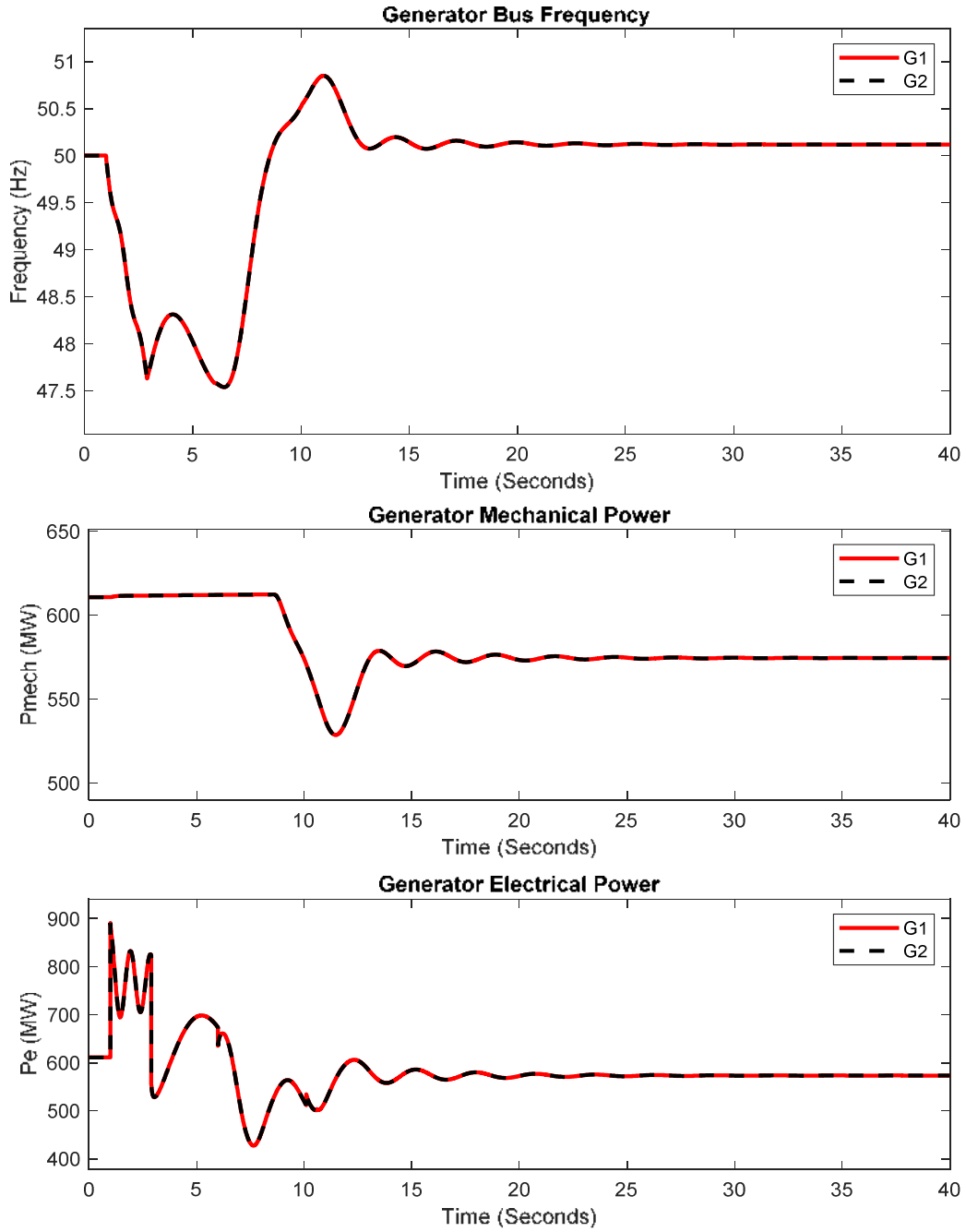

Fig.13: Variations in frequency, mechanical power and electrical power in case of islanding during peak load, peak initial generation with two generators connected to the grid. UFLS and over frequency load reconnection are used to stabilize the frequency in the island.



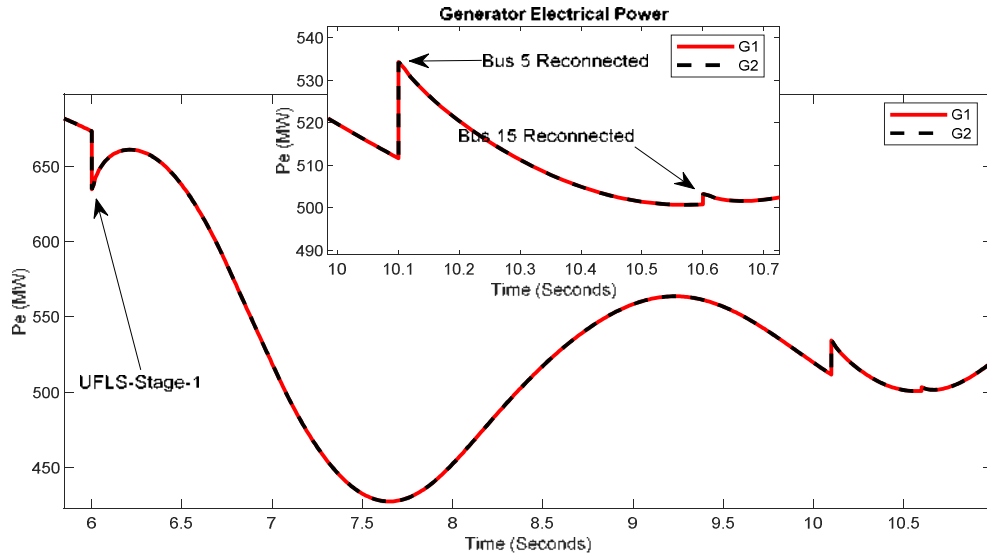

Fig.14: A portion of the electrical power output curve is zoomed to show UFLS and OFLR events.

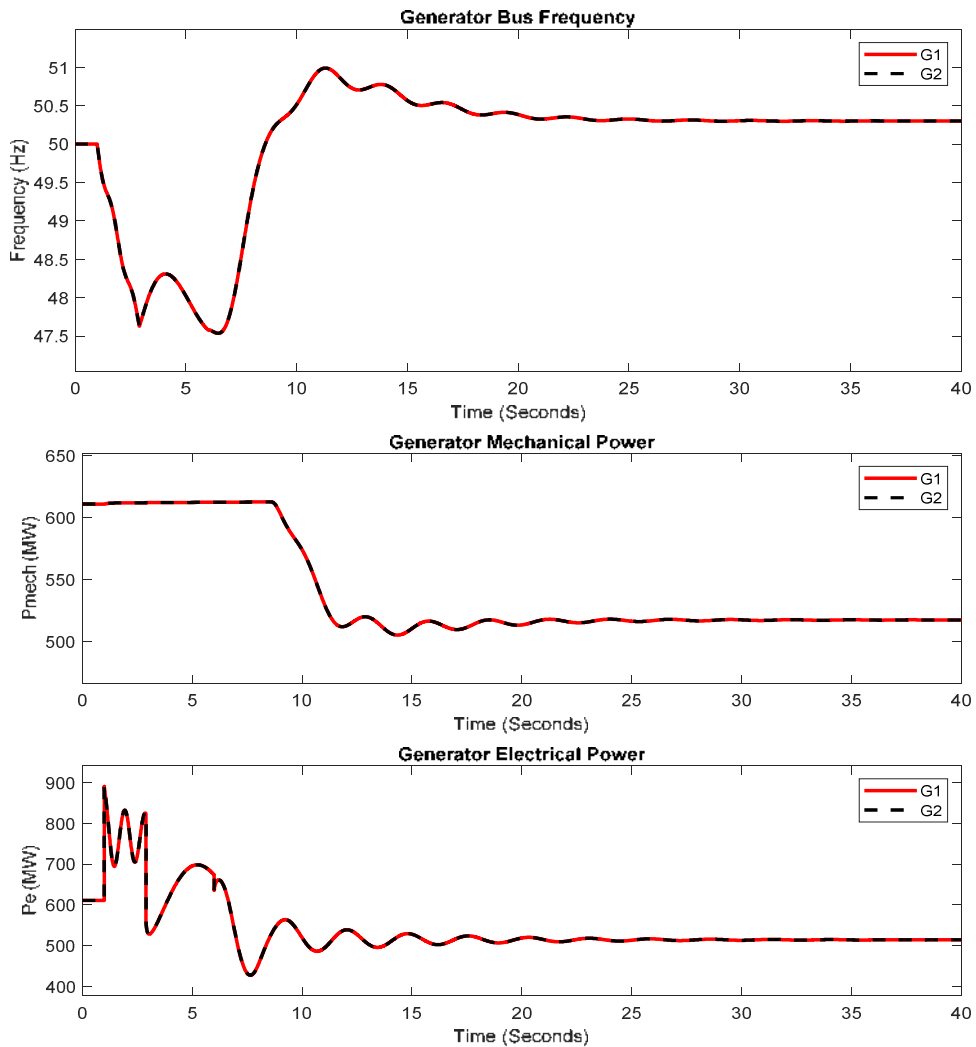

Fig.15: Variations in frequency, mechanical power and electrical power in case of islanding during peak load, peak initial generation with three generators connected to the grid. No over frequency load reconnection is done.

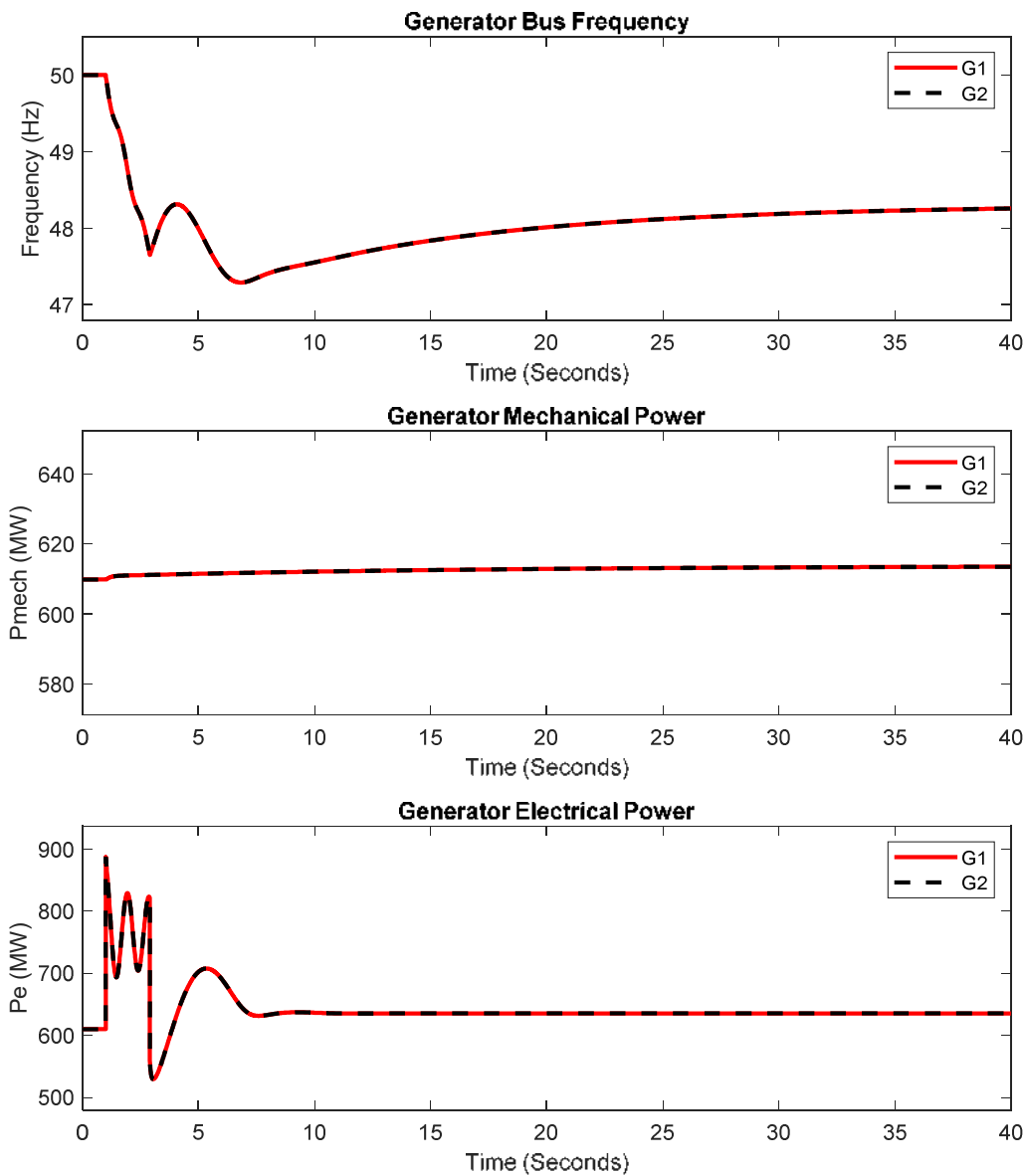

Fig.16: Variations in frequency, mechanical power and electrical power in case of islanding during peak load, peak initial generation with two generators connected to the grid. No load shedding was done.

**Conclusion:** UFLS helps in stabilizing the frequency after islanding in case of high generation deficit in the island before islanding. Over frequency load reconnection helps in preventing over frequency after load shedding and minimizing the difference between mechanical power and electrical power.

#### 9.4.11 Case 11: Peak Load-Two Generators- Average Initial Generation

This case study presents simulation results for islanding event during the following condition:

Number of Generators ON before Islanding = 2

Initial Power Output of Generators =  $460 \times 2 = 920$  MW (Average Generation)

Load in the Island = 1337 MW (Peak Load)

**Description:** A large generator in the external area was tripped at 1s, which results in increase in electrical power of the Lalitpur generators and system wide frequency fall just after the generator tripping event. Mechanical power increases during the frequency fall due to droop control. Islanding happens at 47.9 Hz. Total electrical load is higher than the mechanical power. Therefore, frequency begins to fall. As the frequency falls below 47.6 Hz, UFLS-stage 1 and stage-2 occur to restrict further fall in frequency. Frequency is restored due to reduction in electrical loads. As the frequency continues to increase beyond 50.5 Hz, loads at bus 153305 is reconnected. It can be seen from Fig. 17 that load reconnection helps in reducing the difference between post island and pre island steady state power output of generators.

Without control action/ load shedding & reconnection: If no control action is taken, frequency continues to fall till 45 Hz after islanding as shown in Fig. 18. Both the generators will be tripped by the existing protection schemes.

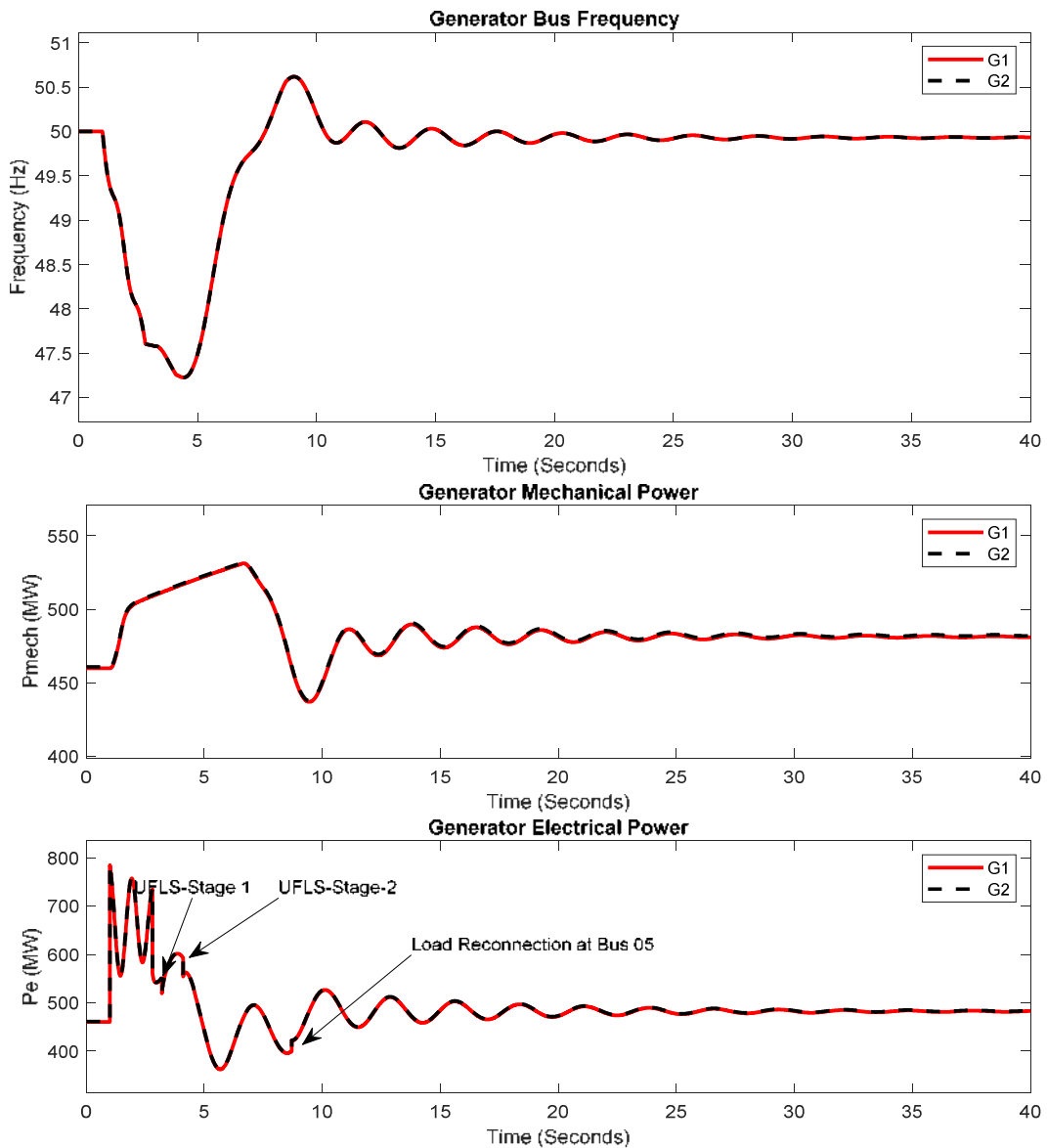

Fig.17: Variations in frequency, mechanical power and electrical power in case of islanding during peak load, average initial generation with two generators connected to the grid. UFLS and over frequency load reconnection were done to stabilize the frequency in the island.

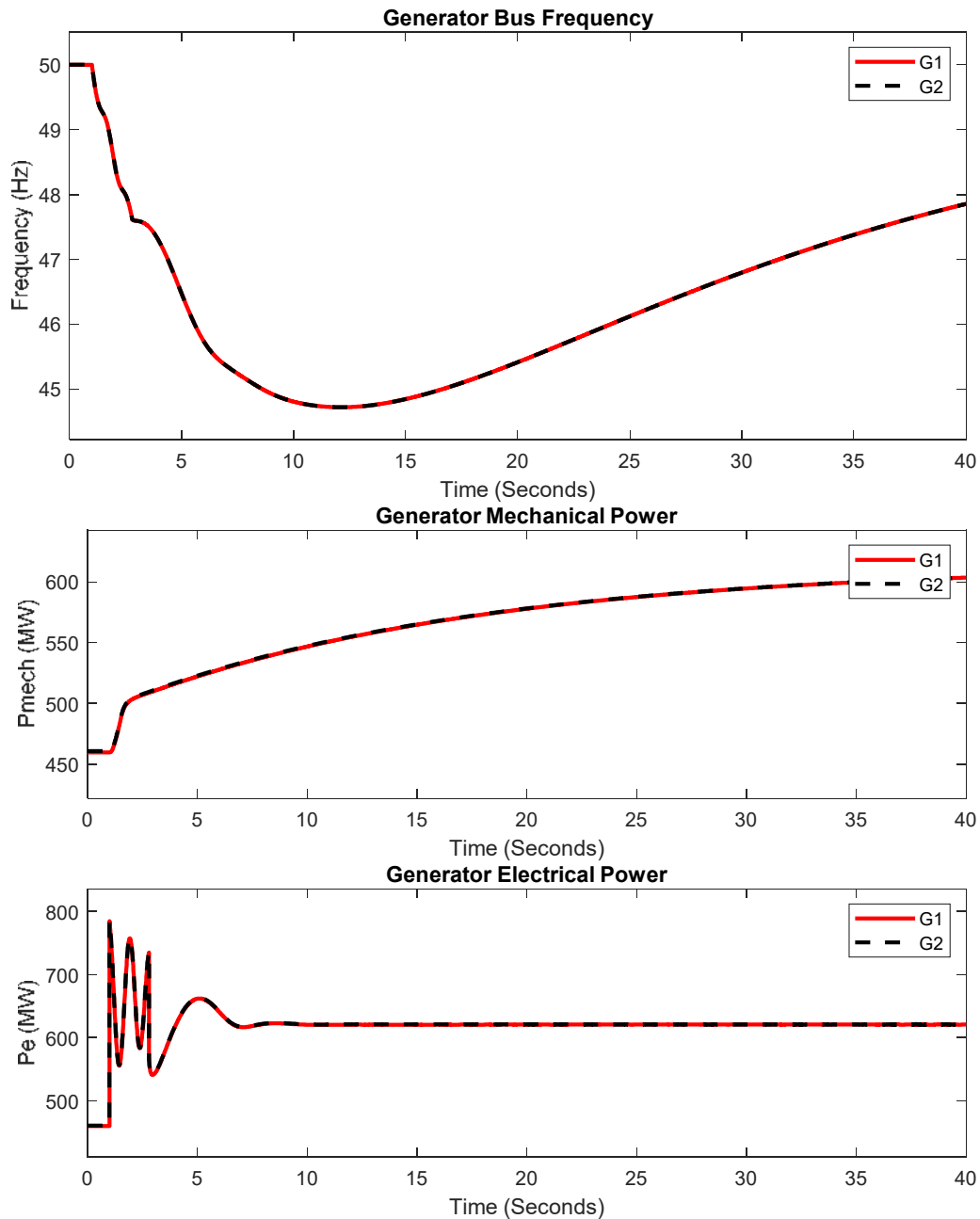

Fig.18: Variations in frequency, mechanical power and electrical power in case of islanding during peak load, average initial generation with two generators connected to the grid. No load shedding and load reconnection was done.

**Conclusion:** UFLS helps in stabilizing the frequency after islanding in case of high generation deficit in the island before islanding. Over frequency load reconnection helps in preventing over frequency after load shedding and minimizing the difference between mechanical power and electrical power.

#### 9.4.12 Case 12: Peak Load-Two Generators-Minimum Initial Generation

This case study presents simulation results for islanding event during the following condition:

Number of Generators ON before Islanding = 2

Initial Power Output of Generators =  $330 \times 2 = 660$  MW (Minimum Generation)

Load in the Island = 1337 MW (Peak Load)

Description: A large generator in the external area was tripped at 1s, which results in increase in electrical power of the Lalitpur generators and system wide frequency fall just after the generator tripping event. Mechanical power increases during the frequency fall due to droop control. Islanding happens at 47.9 Hz. Total electrical load is higher than the mechanical power. Therefore, frequency begins to fall. As the frequency falls below 47.1 Hz, UFLS-stage 1-3 occur to restrict further fall in frequency. Frequency is restored due to reduction in electrical loads, as shown in Fig. 19. Frequency doesn't increase beyond 50.5 Hz, loads reconnection is not required.

Without Control Action/UFLS-Load Reconnection: It can be seen from Fig. 20 that frequency will continue to fall till 42 Hz if no load shedding is done. Therefore, both the generators will be disconnected by the existing protection schemes of the plant.

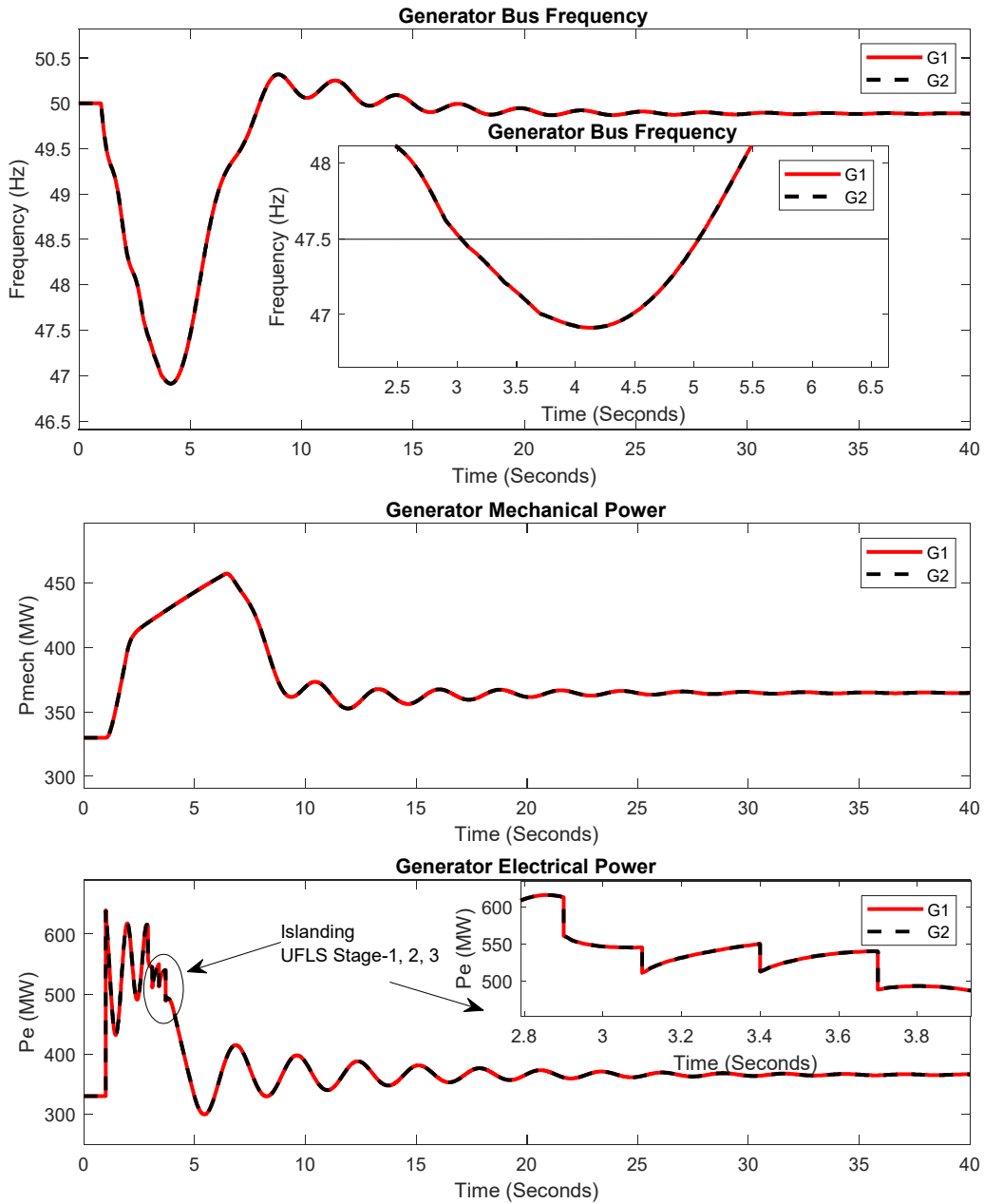

Fig.19: Variations in frequency, mechanical power and electrical power in case of islanding during peak load, minimum initial generation with two generators connected to the grid. UFLS and OFLR were done to stabilize the frequency in the island.

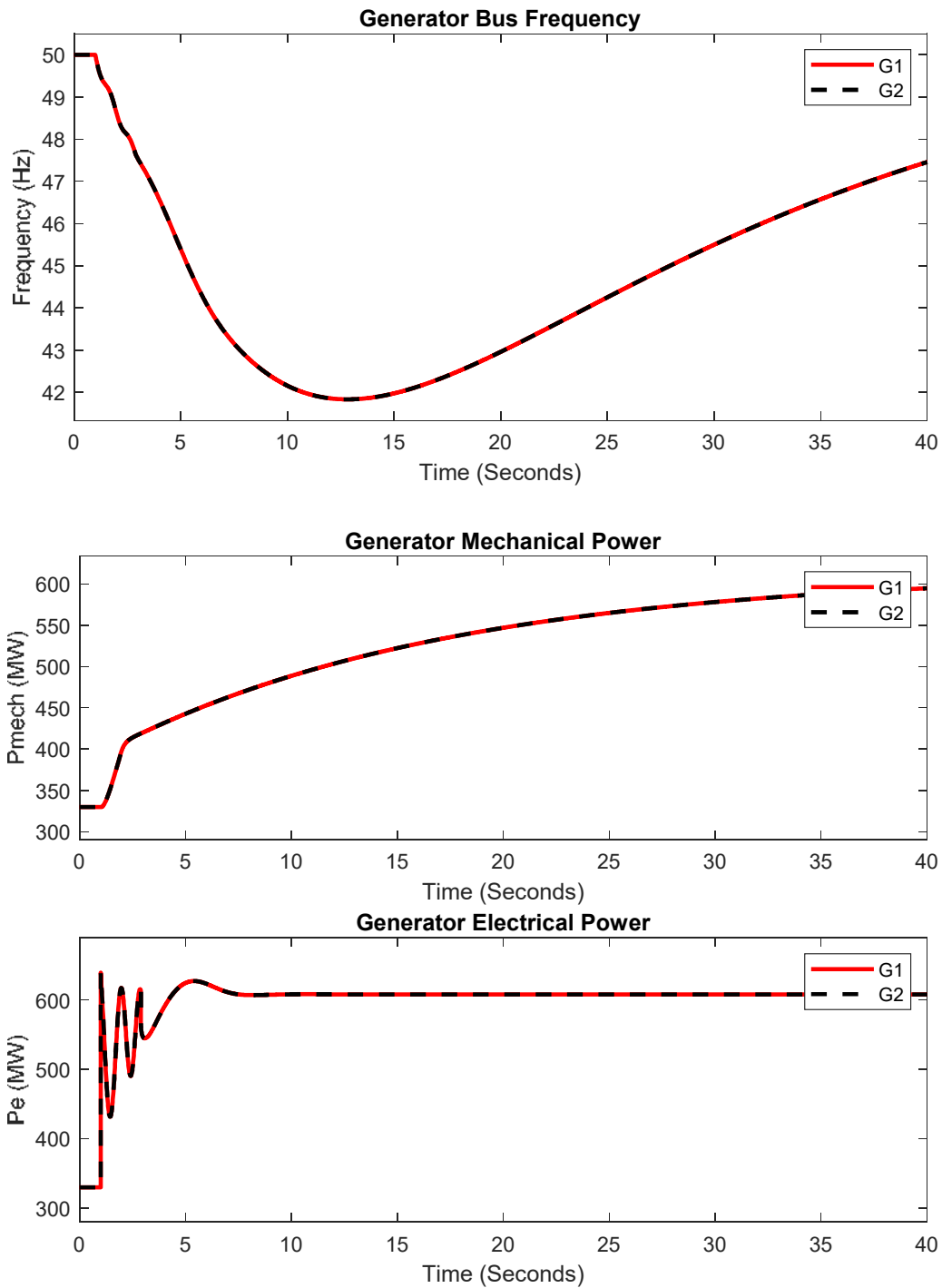

Fig.20: Variations in frequency, mechanical power and electrical power in case of islanding during peak load, minimum initial generation with two generators connected to the grid. No load shedding was done.

**Conclusion:** UFLS relays help in restricting the frequency fall in case of islanding during power deficit in the island.



### 9.4.13 Case 13: Average Load-Two Generators-Peak Initial Generation

This case study presents simulation results for islanding event during the following condition:  
Number of Generators ON before Islanding = 2

Initial Power Output of Generators =  $610 \times 2 = 1220$  MW (Peak Generation)

Load in the Island = 950 MW (Average Load)

Description: Frequency fall was created by tripping a large generator in the external area, which results in increase in electrical power just after the generator tripping event. Islanding happens at 47.9 Hz. As the mechanical power during islanding is higher than the post islanding load, frequency rises after islanding as shown in Fig. 21. As mechanical power is already at maximum before islanding, it remains same during the frequency fall. Governor action is able to regulate the frequency after islanding without any load shedding or generator tripping.

Conclusion: No control action is required in case of islanding during average load and peak generation when two generators are connected to the grid.

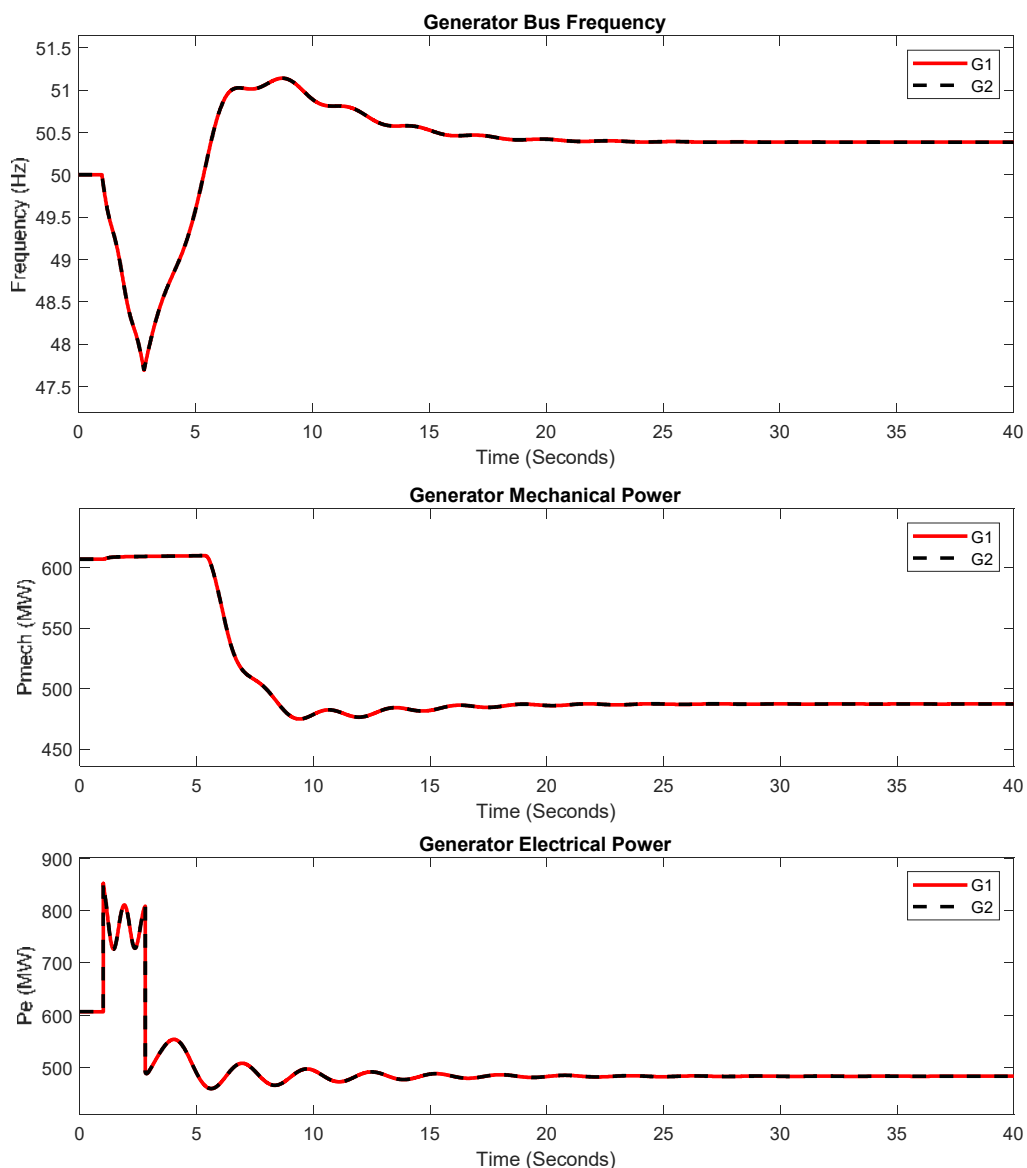

Fig.21: Variations in frequency, mechanical power and electrical power in case of islanding during average load, peak initial generation with two generators connected to the grid.

#### 9.4.14 Case 14: Average Load-Two Generators-Average Initial Generation

This case study presents simulation results for islanding event during the following condition:  
Number of Generators ON before Islanding = 2

Initial Power Output of Generators =  $460 \times 2 = 920$  MW (Average Generation)

Load in the Island = 950 MW (Average Load)

**Description:** Frequency fall was created by tripping a large generator in the external area, which results in increase in electrical power just after the generator tripping event. Islanding happens at 47.9 Hz. Mechanical power increases during the frequency fall due to governor droop control. As the mechanical power during islanding is higher than the post islanding load, frequency rises after islanding as shown in Fig.22. As shown in Fig. 22, governor action is able to regulate the frequency after islanding without any load shedding or generator tripping.

**Conclusion:** No control action is required in case of islanding during average load and average generation when two generators are connected to the grid.

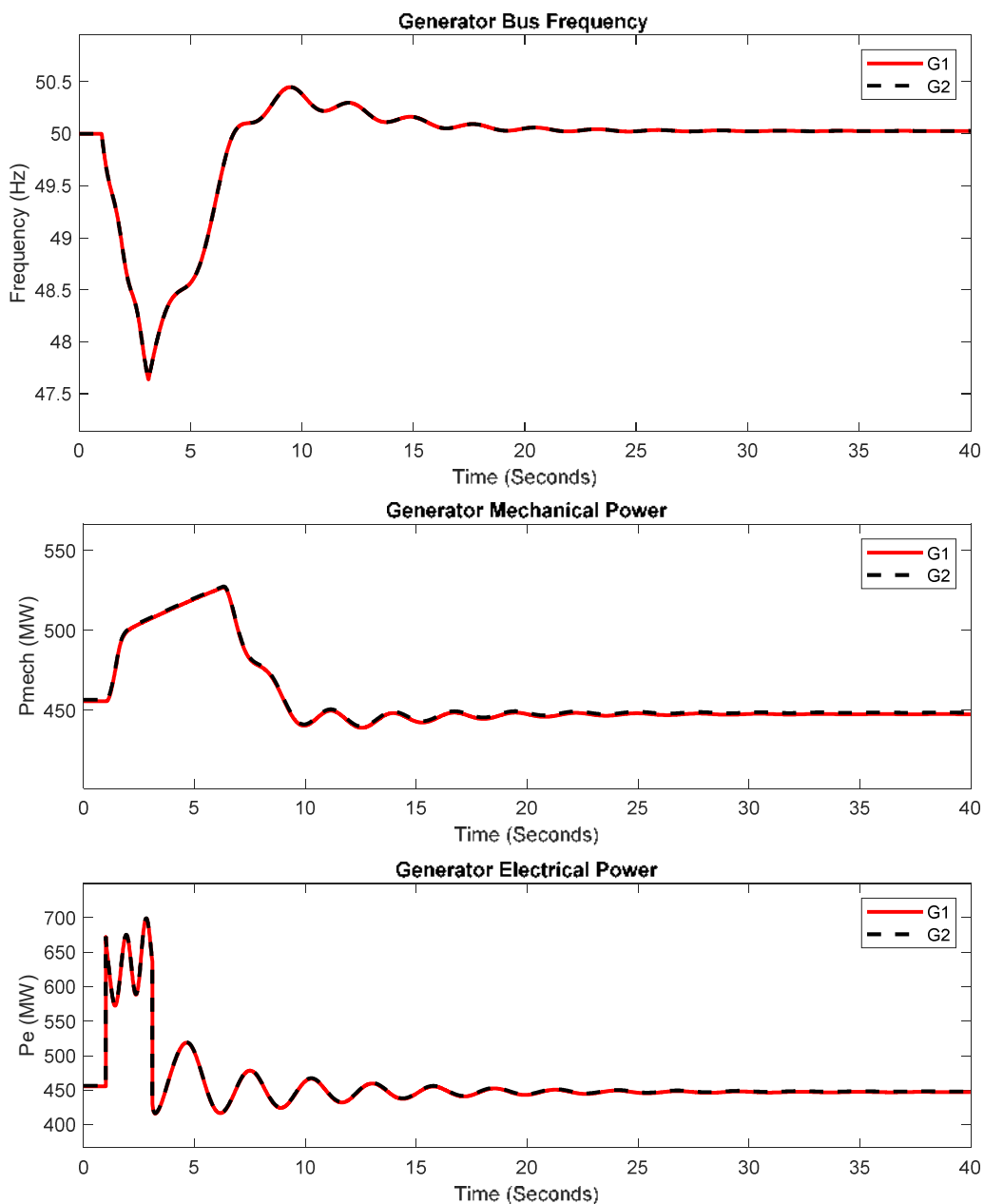

Fig.22: Variations in frequency, mechanical power and electrical power in case of islanding during average load, average initial generation with two generators connected to the grid.

### 9.4.15 Case 15: Average Load-Two Generators-Minimum Initial Generation

This case study presents simulation results for islanding event during the following condition:  
Number of Generators ON before Islanding = 2

Initial Power Output of Generators =  $330 \times 2 = 660$  MW (Low Generation)

Load in the Island = 950 MW (Average Load)

**Description:** Frequency fall was created by tripping a large generator in the external area, which results in increase in electrical power just after the generator tripping event. Islanding happens at 47.9 Hz. Mechanical power increases during the frequency fall due to governor action. As the mechanical power at the time of islanding is higher than the post islanding load, frequency rises after islanding as shown in Fig.23. Governor action is able to regulate the frequency after islanding without any load shedding or generator tripping.

**Conclusion:** No control action is required in case of islanding during average load and minimum initial generation when two generators are connected to the grid.

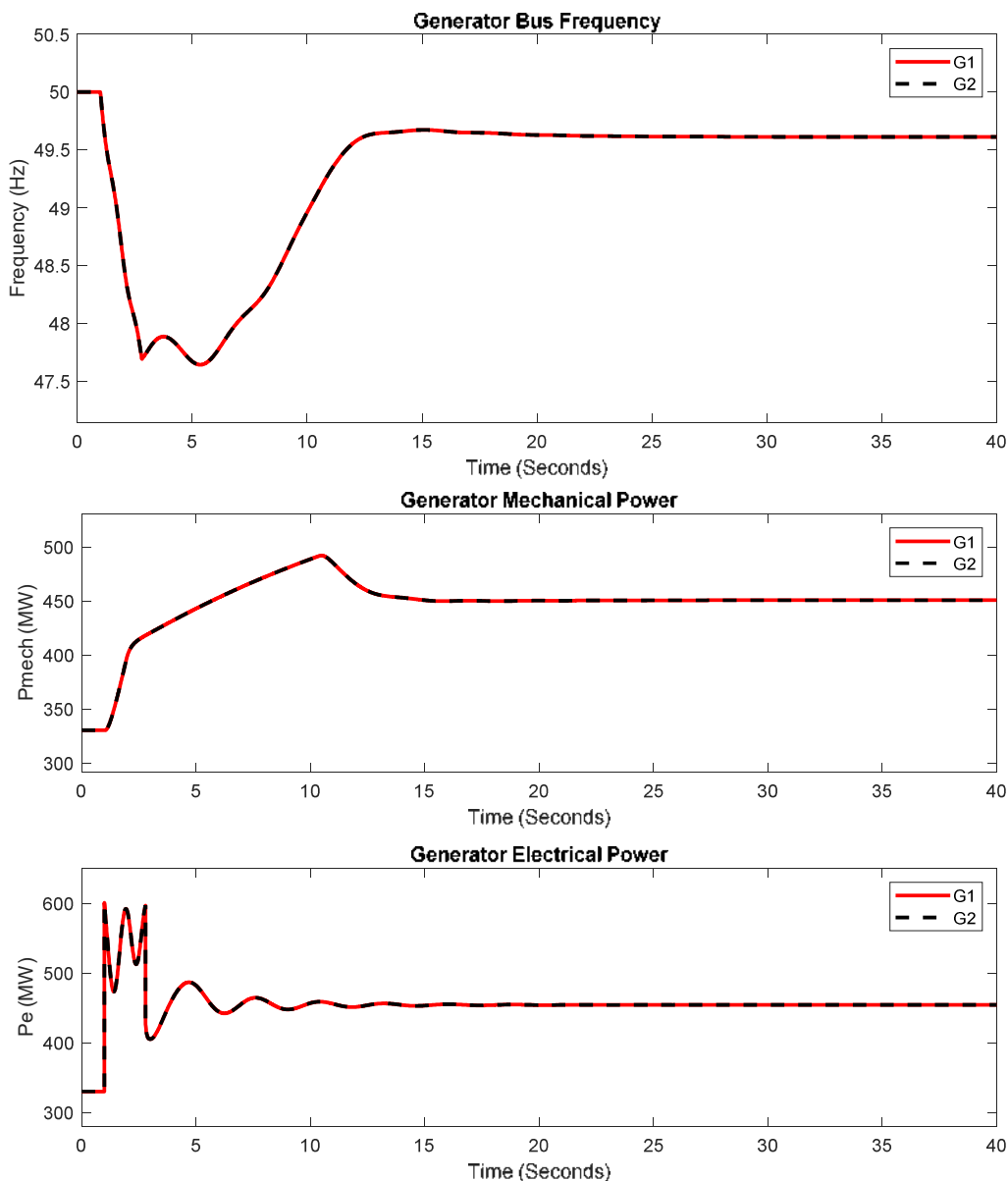

Fig.23: Variations in frequency, mechanical power and electrical power in case of islanding during average load, minimum initial generation with two generators connected to the grid.

### 9.4.16 Case 16: Minimum Load-Two Generators-Peak Initial Generation

This case study presents simulation results for islanding event during the following condition:  
Number of Generators ON before Islanding = 2

Initial Power Output of Generators =  $610 \times 2 = 1220$  MW (Peak Generation)

Load in the Island = 870 MW (Minimum Load)

**Description:** Frequency fall was created by tripping a large generator in the external area at 1s, which results in increase in electrical power just after the generator tripping event. Islanding happens at 47.9 Hz. Mechanical power is at maximum value initially, hence it doesn't increase during frequency fall. As the mechanical power during islanding is higher than the post islanding load, frequency rises after islanding as shown in Fig.24. Governor action is able to regulate the frequency after islanding without any load shedding or generator tripping.

**Conclusion:** No control action is required in case of islanding during minimum load and peak generation when two generators are connected to the grid.

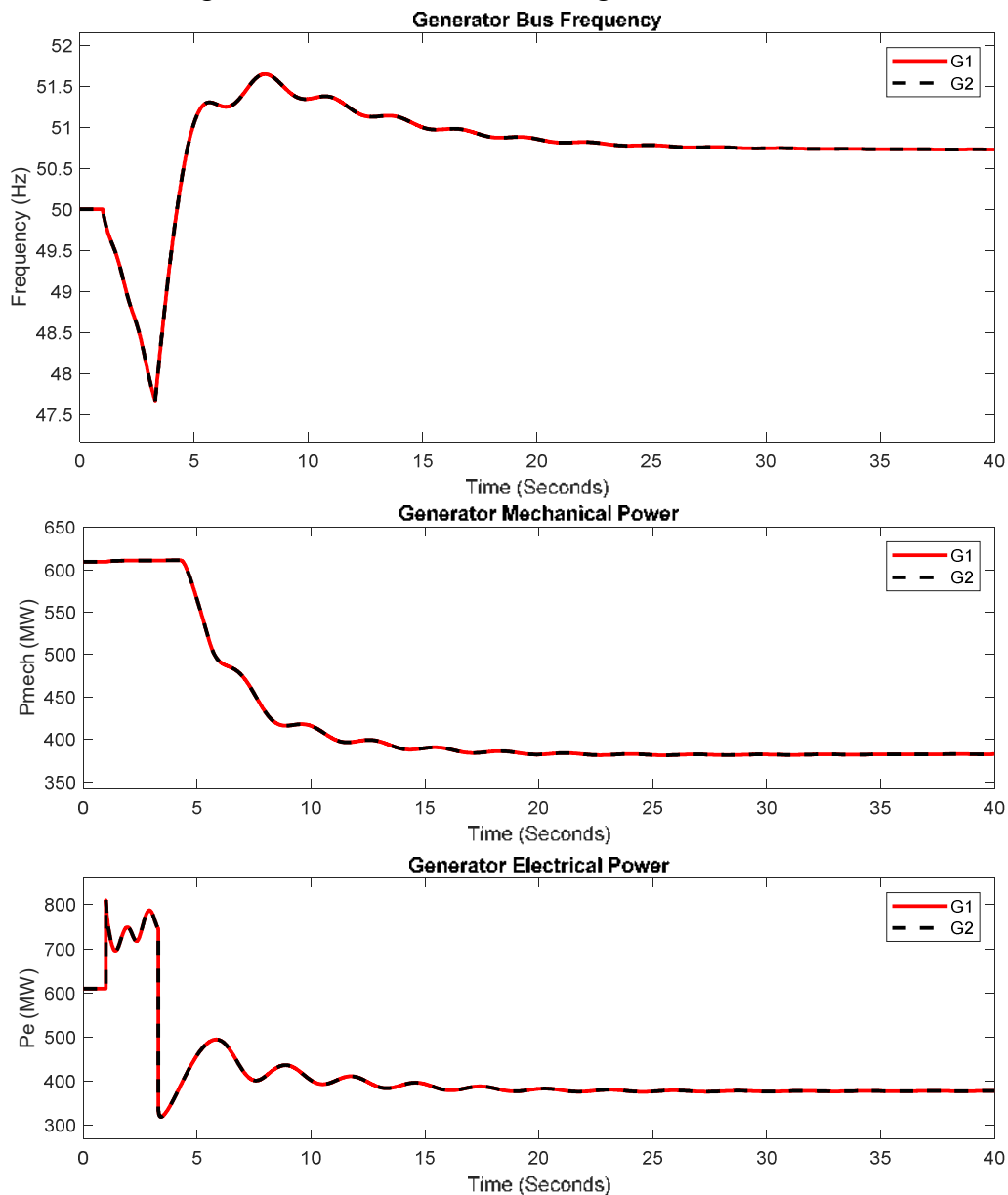

Fig.24: Variations in frequency, mechanical power and electrical power in case of islanding during minimum load, peak initial generation with two generators connected to the grid.

#### 9.4.17 Case 17: Minimum Load-Two Generators-Average Initial Generation

This case study presents simulation results for islanding event during the following condition:

Number of Generators ON before Islanding = 2

Initial Power Output of Generators =  $460 \times 2 = 920$  MW (Average Generation)

Load in the Island = 870 MW (Minimum Load)

**Description:** Frequency fall was created by tripping a large generator in the external area at 1s, which results in increase in electrical power just after the generator tripping event. Islanding happens at 47.9 Hz. Mechanical power increases during the frequency fall due to governor action. As the mechanical power during islanding is higher than the post islanding load, frequency rises after islanding as shown in Fig.25. Governor action is able to regulate the frequency after islanding without any load shedding or generator tripping.

**Conclusion:** No control action is required to regulate the frequency in the island in case of islanding during average load and average generation when two generators are connected to the grid.

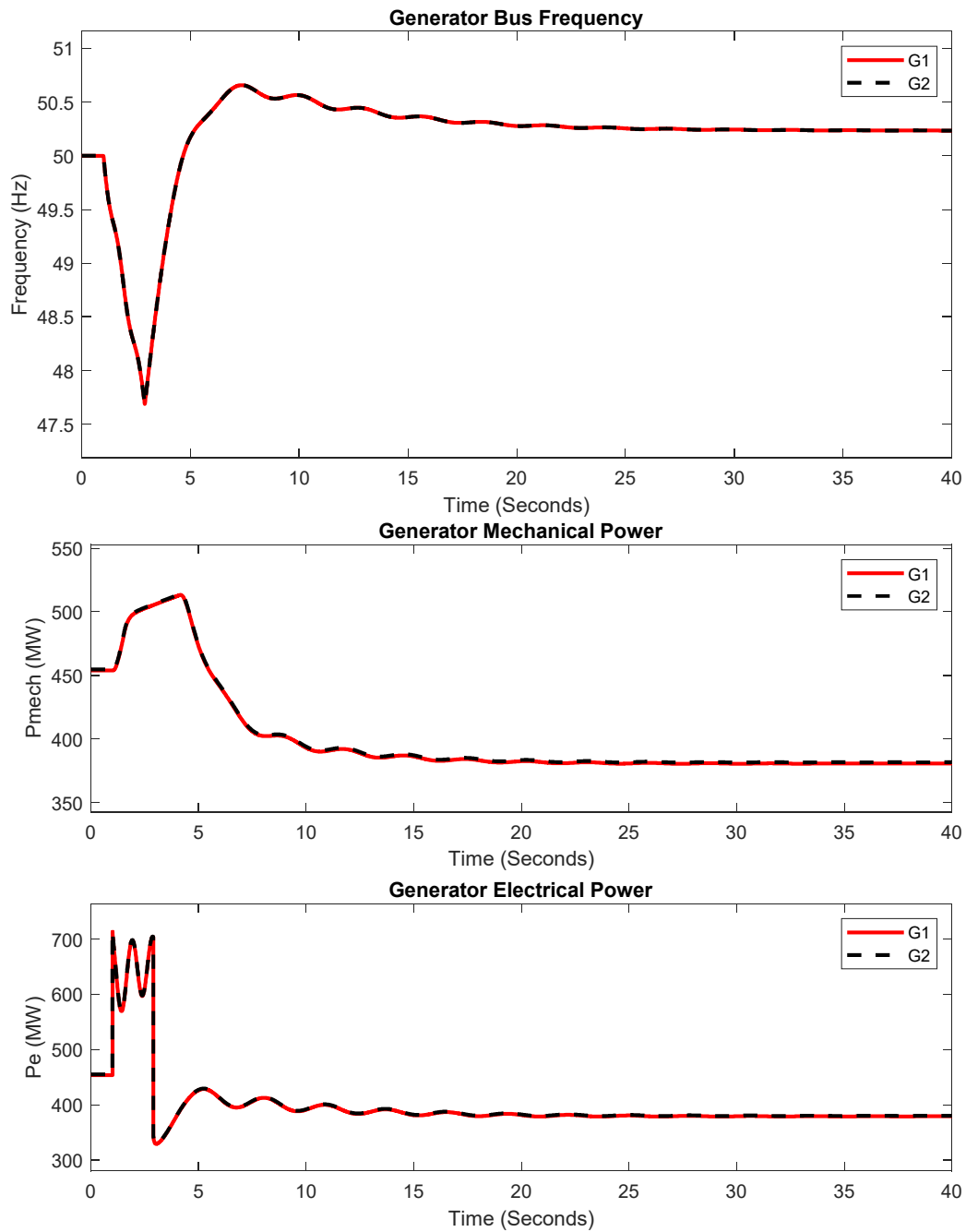

Fig.25: Variations in frequency, mechanical power and electrical power in case of islanding during minimum load, average initial generation with two generators connected to the grid.

### 9.4.18 Case 18: Minimum Load-Two Generators-Minimum Initial Generation

This case study presents simulation results for islanding event during the following condition:  
Number of Generators ON before Islanding = 2

Initial Power Output of Generators =  $330 \times 2 = 660$  MW (Minimum Generation)

Load in the Island = 870 MW (Minimum Load)

**Description:** Frequency fall was created by tripping a large generator in the external area at 1s, which results in increase in electrical power just after the generator tripping event. Islanding happens at 47.9 Hz. Mechanical power increases during the frequency fall due to governor action. As the mechanical power at the time of islanding is higher than the post islanding load, frequency rises after islanding as shown in Fig.26. Governor action is able to regulate the frequency after islanding without any load shedding or generator tripping.

**Conclusion:** No control action is required to regulate the frequency in the island in case of islanding during average load and average generation when two generators are connected to the grid.

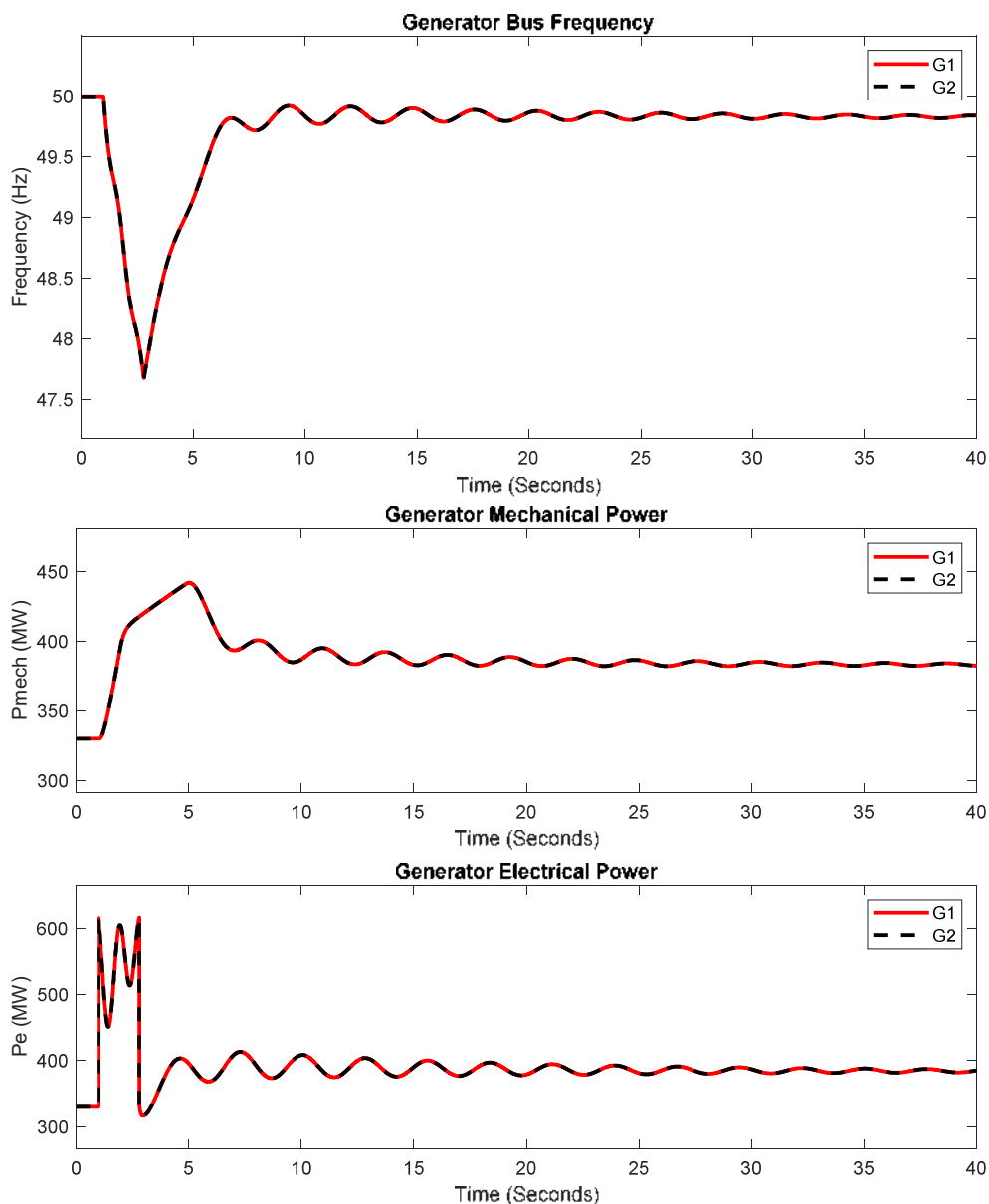

Fig.26: Variations in frequency, mechanical power and electrical power in case of islanding during minimum load, minimum initial generation with two generators connected to the grid.

## 9.5 Summary of Simulation Test Cases

A summary of the eighteen simulation test cases with details on number of generators, initial generation, load in the island and control action required to stabilize the frequency in the island are provided in Table VIII.

**Table VIII: Summary of the simulation Test cases**

<b>Case Number</b>	<b>Ngen</b>	<b>P gen</b>	<b>Pload</b>	<b>Comment</b>
1	3	610 MW	1337 MW	No control action is required
2	3	460 MW	1337 MW	No control action is required
3	3	330 MW	1337 MW	No control action is required
4	3	610 MW	950 MW	OFGT
5	3	460 MW	950 MW	No control action is required to stabilize frequency. But, $P_{gen} < P_{gmin}$ .
6	3	330 MW	950 MW	No control action is required to stabilize frequency. But, $P_{gen} < P_{gmin}$ .
7	3	610 MW	840 MW	OFGT
8	3	460 MW	840 MW	No control action is required to stabilize frequency. But, $P_{gen} < P_{gmin}$ .
9	3	330 MW	840 MW	No control action is required to stabilize frequency. But, $P_{gen} < P_{gmin}$ .
10	2	610 MW	1337 MW	UFLS-Stage-1 (332 MW) Then Load reconnect at bus 153305 and 153315 (160 MW)
11	2	460 MW	1337 MW	UFLS-Stage 1&2. Load Reconnected at bus 153305
12	2	330 MW	1337 MW	UFLS- Stage-1,2,3
13	2	610 MW	950 MW	No control action is required
14	2	460 MW	950 MW	No control action is required
15	2	330 MW	950 MW	No control action is required
16	2	610 MW	840 MW	No control action is required
17	2	460 MW	840 MW	No control action is required
18	2	330 MW	840 MW	No control action is required



## **9.6 Islanding During One Machine Connected to Grid:**

As per the discussion with the plant operator, most of the time at least two generators are connected to the grid in Lalitpur plant. Therefore, the relay settings have been studied considering either two or three generators connected to the grid. However, if only one generator is connected to the grid and islanding happens at that time, frequency in the island may be stabilized by the proposed relays if the difference between generation and load in the island is low. Two case studies are presented for this purpose- first, successful islanded operation during winter off peak load and second, unsuccessful islanded operation in summer peak load.

### **9.6.1 Islanding During One Machine ON, Winter Load, Minimum Initial Generation:**

This case study presents simulation results for islanding event during the following condition:

Number of Generators ON before Islanding = 1

Initial Power Output of Generators = 330 MW (Minimum Generation)

Load in the Island = 850 MW (Minimum Load)

Description: A large generator in the external area was tripped at 1s, which results in increase in electrical power of the Lalitpur generator and system wide frequency fall just after the generator tripping event. Mechanical power increases during the frequency fall due to droop control. Islanding happens at 47.9 Hz. Total electrical load is higher than the mechanical power. Therefore, frequency begins to fall. As the frequency falls below 47.1 Hz, UFLS-stage 1-3 occur to restrict further fall in frequency as shown in Fig. 27. Frequency is restored due to reduction in electrical loads. Frequency doesn't increase beyond 50.5 Hz, loads reconnection is not required

Conclusion: If the difference between generation (330MW in this case) and load (850MW in this case) is low, frequency can be stabilized using load shedding and inherent governor control even if there is just one generator connected to the grid.

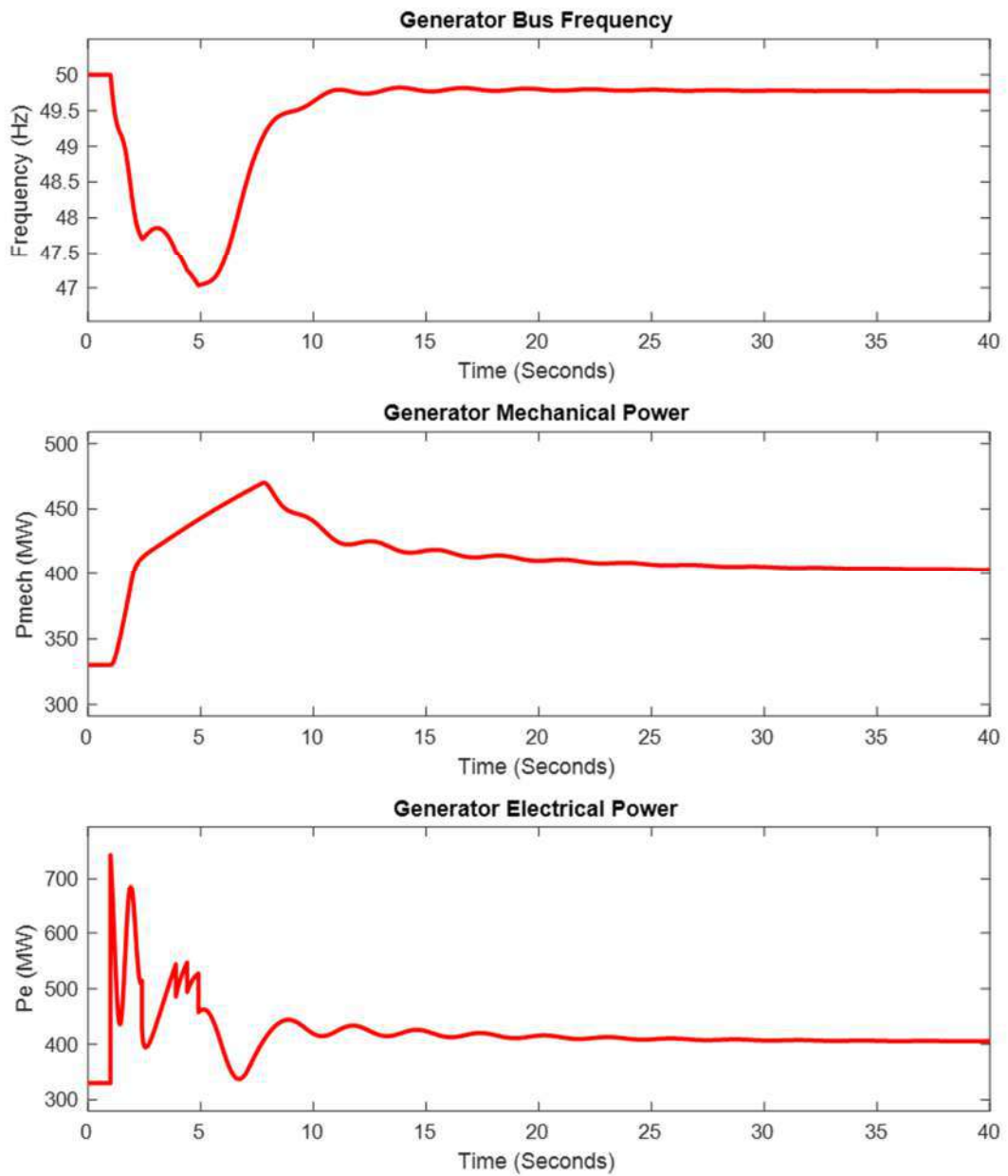

Fig.27: Variations in frequency, mechanical power and electrical power in case of islanding during minimum load, minimum initial generation with one generators connected to the grid.

### 9.6.2 Islanding During One Machine ON, Summer Load, Winter Load, Minimum Initial Generation:

This case study presents simulation results for islanding event during the following condition:

Number of Generators ON before Islanding = 1

Initial Power Output of Generators = 330 MW (Minimum Generation)

Load in the Island = 1337 MW (Peak Load)

**Description:** A large generator in the external area was tripped at 1s, which results in increase in electrical power of the Lalitpur generator and system wide frequency fall just after the generator tripping event. Mechanical power increases during the frequency fall due to droop control. Islanding happens at 47.9 Hz. Total electrical load is higher than the mechanical power. Therefore, frequency begins to fall. As the frequency falls below 47.1 Hz, UFLS-stage 1-3 occur to restrict further fall in frequency. However, even after load shedding, electrical power in the island is higher than the generation capacity of one generator. Therefore, frequency continues to fall and the frequency could not be stabilized as shown in Fig. 28.

**Conclusion:** If the difference between generation (330MW) and load (1337 MW) and the electrical load after load shedding are high, frequency cannot be stabilized using load shedding and inherent governor control. Successful operation of the island in case of one machine ON and peak load is not possible. However, this is probably not a practical operating condition or has have too low probability to occur.

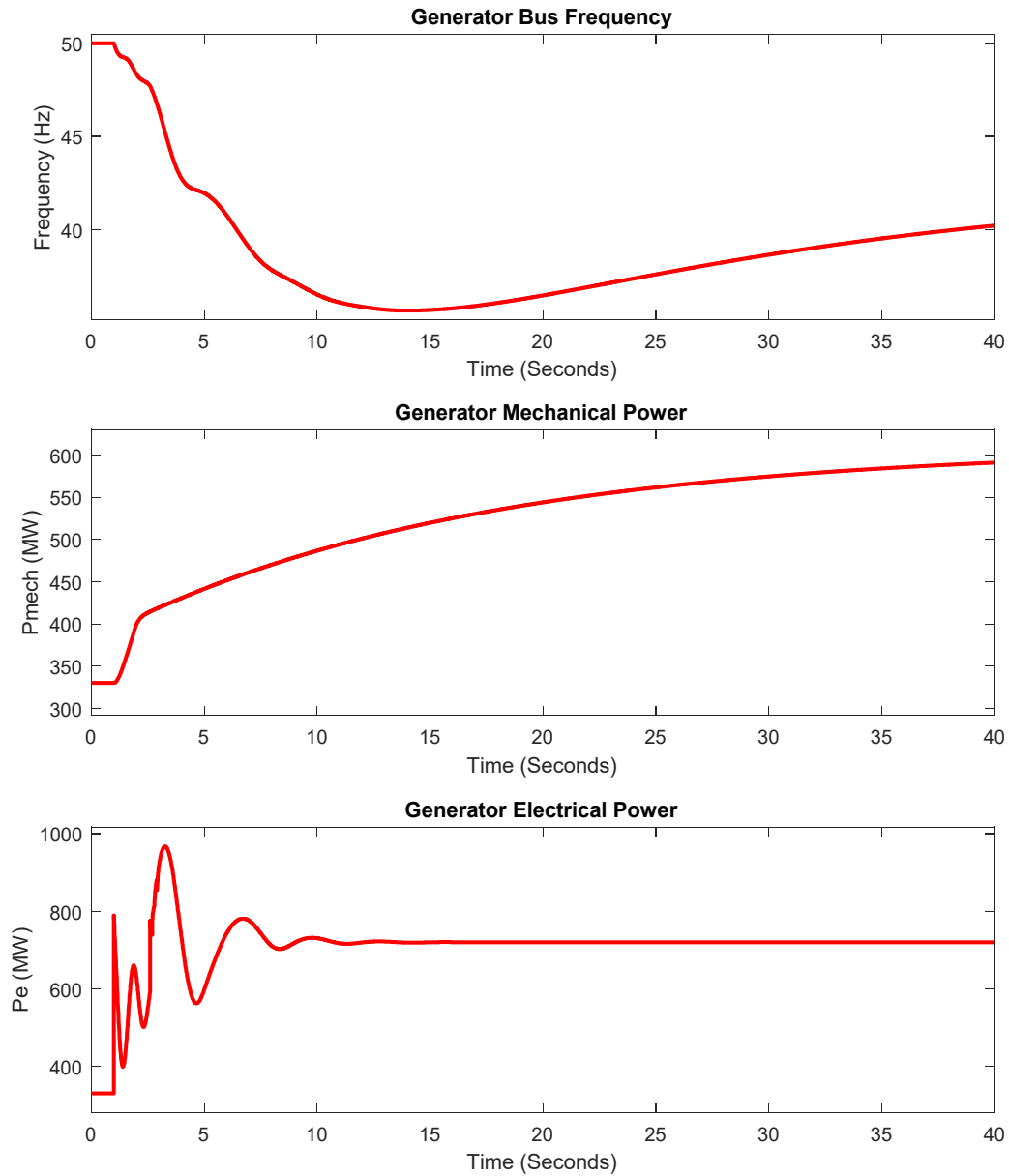

Fig.28: Variations in frequency, mechanical power and electrical power in case of islanding during peak load, minimum initial generation with one generator connected to the grid.

## 10.0 Change in Plant/System Control Settings

- 10.1 Under frequency generation tripping below 47.5 Hz: Change the delay to 8 seconds or instantaneous tripping at 46.5 Hz.
- 10.2 Is there any limit on governor droop-based control input? It can be removed or at least the droop limit on frequency deviation can be increased to -6% to +5% (47Hz-52.5Hz).
- 10.3 Reactive power should be supplied locally to maintain close to unity power factor in transmission lines. This will prevent any possible voltage instability after islanding during peak load conditions.
- 10.4 Resynchronization After Islanding: Once the grid frequency is restored, the island has to be resynchronized with the rest of the grid. There are multiple lines which need to be closed for this purpose. As per standard practice, the voltage and frequency of the island should match with that of the grid. Also, the phase angle difference should be as small as possible. There are standard relays available in the market to do this automatically which can be used for any system. No separate simulation studies are required specifically for this island. The following reference documents provide details of a similar relay:
- “SEL-451-5-Based Auto synchronizer-A custom-engineered solution for safe, secure auto synchronization of generation onto the power system,” by Schweitzer Engineering Laboratories, Inc.
  - “Case Study: Smart Automatic Synchronization in Islanded Power Systems,” by Schweitzer Engineering Laboratories, Inc

**Comments on Draft Report “Power Systems Static and Dynamic Stability for Agra Islanding Scheme” submitted by CPRI and Replies**

# Comments received on draft report of Agra Islanding scheme and response from CPRI:

Comment 1(Page 8): “Under Frequency Load Shedding (UFLS) is required to restrict the frequency fall. UFLS is proposed in three stages- at 47.6 Hz, 47.3 Hz and 47.1 Hz” ...Generator OEM agreed for these settings?

Response to Comment 1: The settings have been found out after detailed simulation studies for islanding events during various operating conditions. The constraints from OEM provided below have been taken into account while providing above UFLS settings.

## Under Frequency

If  $F_2 < 47.5$  - Class C protection of Generator will operate with a time delay of 3 Seconds. (All running machines will be isolated from grid) .

If  $F_2 < 47.5$  - Class A1 protection of Generator will operate with a time delay of 5 Seconds. ( All running machines will trip)

## Over Frequency

$F > 51.5$  - Turbine will trip With a delay of 30 Seconds. i.e. When the frequency is more than 51.5HZ then trip command is issued to Turbine with a delay of 30 s. Then the generator trips on turbine tripping.

The instantaneous tripping (Over speed tripping) of Turbine is set at 3300 RPM.

Comment 2(Page 8): “Is there any limit on governor droop-based control input? If yes, it can be removed or at least the droop limit on frequency deviation can be increased to -6% to +5% (47Hz- 52.5Hz)”... Not Clear.

Response to the comment2: The droop related data is as follows:

Droop	Droop setting (% on machine base)	5%
	Frequency influence limiters: - Maximum frequency deviation limiter (eg +/-2 Hz) - Maximum influence limiter (eg 10% of rating)	$\pm 0.03$

The sentence is modified as below in final report in page No 9:

The limit on the frequency deviation in the droop control is 3% i.e., 1.5Hz. Hence the droop control works for frequency range of 48.5-51.5Hz. This is fine for normal operation of generators. However, if the limit is removed or at least increased to -6% to +5% (47Hz - 52.5Hz) it will help in increasing the mechanical power during the frequency fall in islanding operation.

Comment 3(Page 13): “Fig.1(a) Proposed Agra Island” may be mentioned as stage-1 and Fig.1(b) may be mentioned as Stage-II

Response to the comment3: Both figures Fig.1(a) and Fig.1(b) together belong to Lalitpur-Agra system which is considered for our study. Load shedding is done in three stages as explained in table V, in section 9.3.1 in Page no 24. The proposed Agra island after Stage I, Stage II and Stage III load shedding is shown in Fig 1.2 , 1.3 and Fig 1.4 provided after section 9.3.1 and added in final report in Page no 27 to 32.

Comment 4(Page 17): Table 8.1.2. whether units would be able to inject this MVar? Measurement at HV side or GT side?

Response to the Comment 4: This is measured at the HV side. The total MVA is well below the rated MVA. Generally, tap changing, capacitor switching and inductor switching is done to maintain voltage profile and power factor. It is expected that the substation operators will take local control actions to maintain voltage and power factor. Therefore, the generators can work close to the unity power factor so that net MVar injection from generators is well within the capability limits.

Comment 5(Page 17): Section 8.2. Tap changing during island formation? Any capacitor or reactor switching required?

Response to comment 5: Yes, Capacitor or reactor switching will help in maintaining the voltage after islanding. Otherwise, the generator power factor may become very poor. The generator active and reactive powers without capacitor or reactor switching are shown in the report.

Comment 6(Page 23): 9.2.2. Block diagram/ Parameters submitted by generators may be mentioned for understanding the selected model along with block diagram of chosen model from PSSe to assess suitability of model.

Response to comment 6:

Block diagrams of generators controls such as exciters, governors and AVR models (used for dynamic modelling in PSSE software) given below are included in final report in Page No 23 to 25.

Generator is modelled with GENROU model. Exciter is modelled with an ESAC1A model and the turbine governor is modelled with IEEEG1 Model in PSSE. stabilizer was modelled with STAB1 model.



## Generator

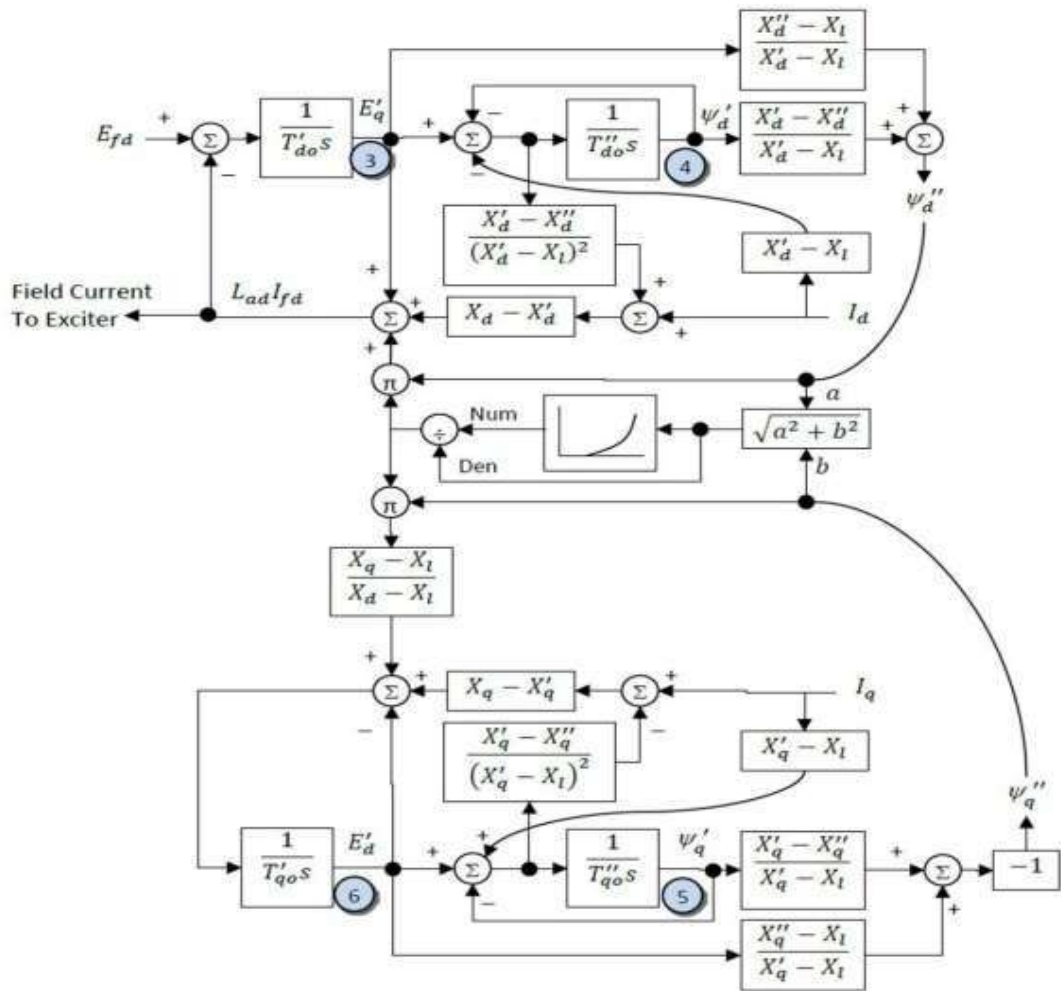

Generator GENROU model

## Generator data

Parameter	Values	Parameter	Values
Tdo'	7.94	Xq	2.3192
Tdo''	0.05	Xd'	0.3347
Tqo'	0.836	Xq'	0.8661
Tqo''	0.07	Xd''=Xq''	0.2495
H	3.7	Xl	0.1749
D	0	S1.0	0



Governor IEEE1 model

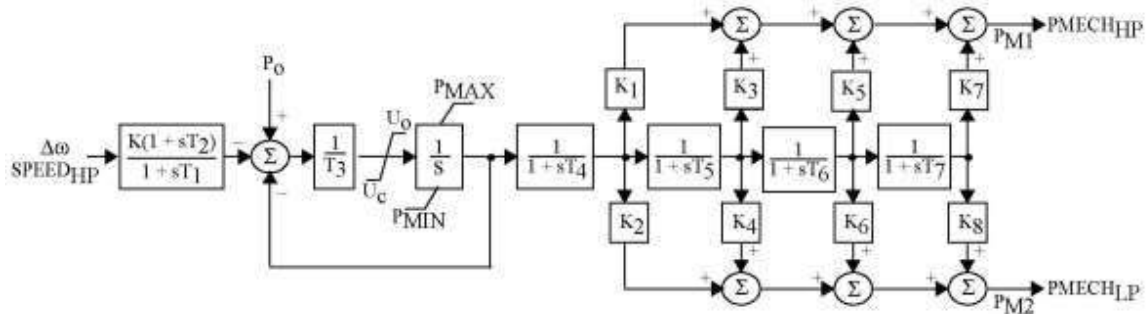

Governor data

Parameter	Values	Parameter	Values
K	20	K2	0
T1	0	T5	16
T2	0	K3	0.38
T3	0.125	K4	0
U0	0.4	T6	0.54
Uc<0	-0.4	K5	0.35
PMAX	0.79	K6	0
PMIN	0	T7	0
T4	0.18	K7	0
K1	0.27	K8	0

PSS Model: AVR-PSS state space model received from the generating plant is given in Fig.1. As a similar model could not be found in PSS/E, PSS was modelled with STAB1 model available in PSS/E

(shown in fig.2). The STAB1 model data is available in the report. It is reiterated that electromechanical oscillations are unlikely to occur in the islanded system as there is only one generating plant in the system. Therefore, modelling of PSS is not necessary for this study

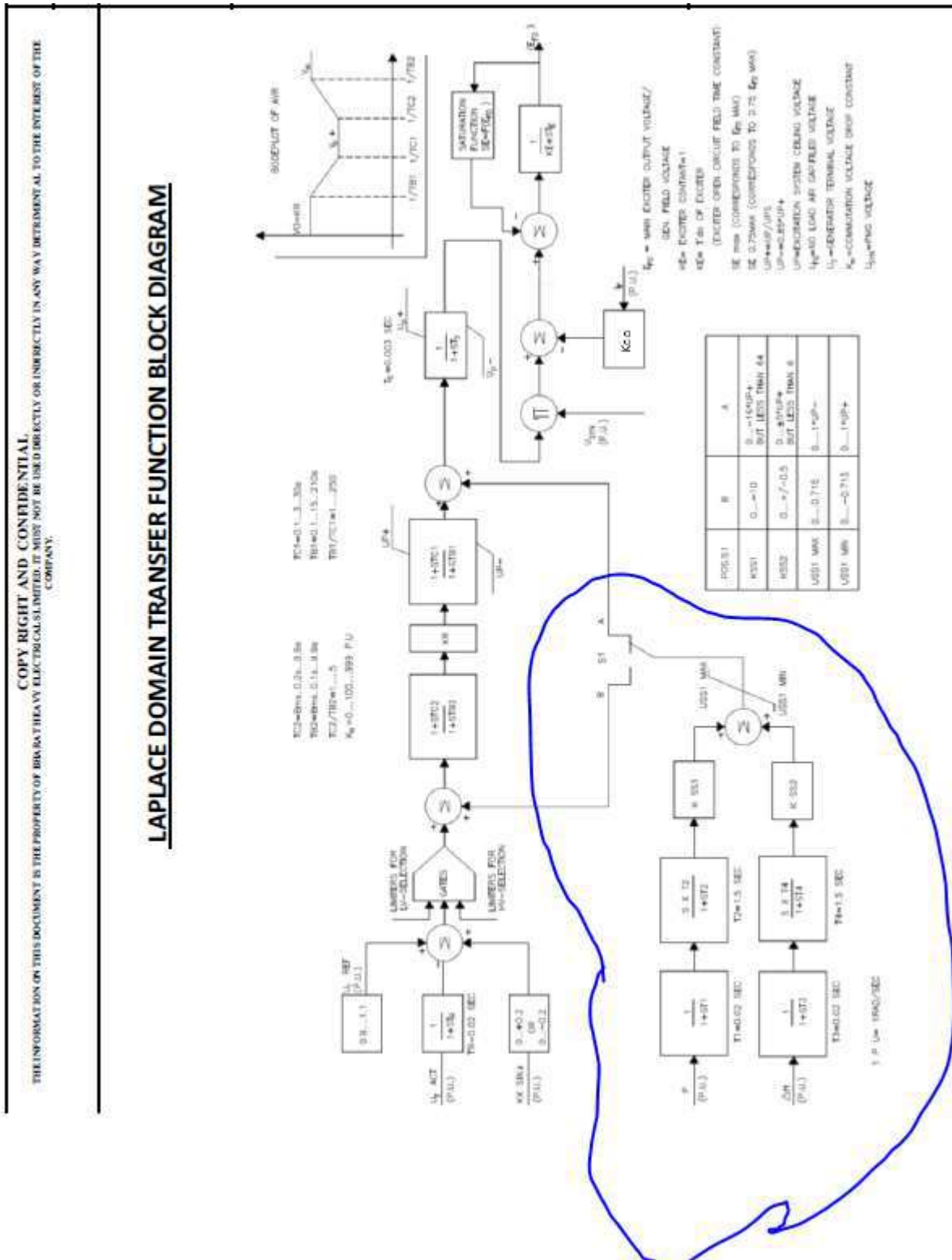

Fig.1. State Space model of combined AVR-PSS as received from the generating plant(given by UPPTCL).

## Stabilizer STAB1

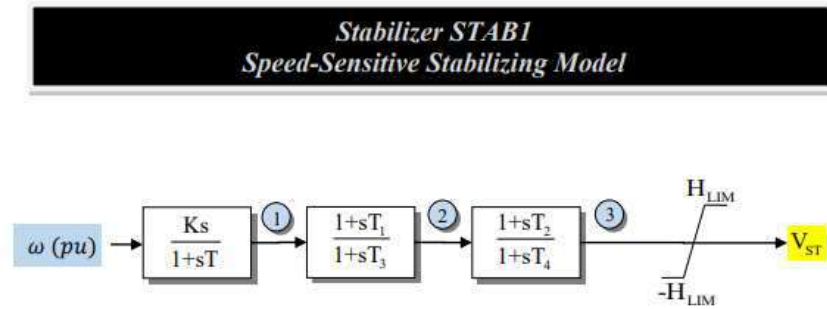

Fig.2. Used model of stabilizer in PSSE

Stabilizer data

Parameter	Values	Parameter	Values
K/T	10	T2/T4	0.05
T	0.9	T4	0.4
T1/T3	0.05	HLIM	0.3
T3	0.9		

Comment 7(Page 23): 9.2.3: Any deadband modelled? Comparison of settings submitted by generator and those used in simulation may be clearly specified.

Response to the Comment 7: No. The prime over is modelled with IEEE1 model which doesn't have provision to include deadband.

The deadband increases frequency fall to some extent for a given disturbance like generator outage in the system. However, in islanding, load shedding and generator tripping is done based on actual frequency measurements, the deadband is unlikely to affect the effectiveness of the method. Generator data provided by the client is used in the simulation studies.

Comment 8(Page 24): 9.3.1: Please recheck these statements

Considering a ROCOF of 2Hz/s for Indian Grid, time taken for frequency to reach from 47.9 Hz to 49.6 Hz is 0.15s. This is sufficient for all the tie lines to be opened to create the island. With UFLS Stage-1, ROCOF is expected to reduce. Therefore, the frequency difference between Stage-2 and Stage-3 (i.e. 0.2Hz) is lesser as compared to frequency difference between Stage-1 and Stage-2 (i.e. 0.3Hz).

Response to the Comment 8:

The sentence is modified as below in final report in Page No 26:

There was a typing mistake. The correct text will be “Considering a ROCOF of 2Hz/s for Indian Grid, time taken for frequency to reach from 47.9 Hz to 47.6 Hz is 0.15s. This is sufficient for all the tie lines to be opened to create the island. With UFLS Stage-1, ROCOF is expected to reduce. Therefore, the frequency difference between Stage-2 and Stage-3 (i.e. 0.2Hz) is lesser as compared to frequency difference between Stage-1 and Stage-2 (i.e. 0.3Hz).”

Comment 9(Page 25): 9.3.2. Needs to be discussed with DISCOMs due to safety concerns

Response to the Comment 9:

There are reports available from other grids where, load reconnection has been implemented along with islanding scheme. Therefore, it should be feasible.

Comment 10(Page 26): Discussion required with OEM

Response to the Comment 10:

The generator tripping scheme proposed is similar to providing multiple ROCOF setting at different frequency values. The proposed scheme is simpler than providing multiple ROCOF threshold at multiple frequency ( $f > 50\text{Hz}$ ).

**Generator Trip Recommendations**  
**from M/s LPGCL**

## Generator Trip Recommendation

2 messages

R. N. Bedi <rnbedi.ltp@lpgcl.com>

Tue, Jan 31, 2023 at 11:01 AM

To: SE <sera@upslcdc.org>

Cc: Alhad Narayan Sar <ansar.ltp@lpgcl.com>, Manoj Mehta <manojm.ltp@lpgcl.com>, Vikash Kumar Sharma <vksharma.ltp@lpgcl.com>, Avinash Kumar <avinashkumar.ltp@lpgcl.com>, Subhranshu Mahapatra <subhranshum.ltp@lpgcl.com>, Mukesh Kumar Pokharna <mkpokharna.ltp@lpgcl.com>, SCR LPGCL Lalitpur <scripgcl.ltp@lpgcl.com>

Dear Sir

This has reference to your email dated 12.01.2023 regarding Agra Islanding study. The matter was referred to the OEM, M/s Siemens. Please refer the trailing mail from M/s Siemens with respect to :

1. Under-frequency operations beyond specified limits of lower frequency and/or increased time duration
2. Over frequency limits for Generator/Turbine.

Siemens Reply is self explanatory.

**Regards**

**Rudra Narayan Bedi**

President & Head Maintenance

[rnbedi.ltp@lpgcl.com](mailto:rnbedi.ltp@lpgcl.com)

Lalitpur Power Generation Company Limited

Village Mirchwarra Burogaon,

Tehsil Mehrauni, Lalitpur -284 123

Uttar Pradesh

Mob:+91-9151897307

Office:+91-5176272257

[www.lpgcl.com](http://www.lpgcl.com)

From: "Hooda, Sandeep" <sandeep.hooda@siemens.com>

To: "R. N. Bedi" <rnbedi.ltp@lpgcl.com>

Cc: Alhad Narayan Sar <ansar.ltp@lpgcl.com>, Manoj Mehta <manojm.ltp@lpgcl.com>, "Ramanujalu, Suresh" <ramanujalu.suresh@siemens.com>,

"Anugonda, Ramesh" <anugonda.ramesh@siemens.com>, "narendra.singh.ext@siemens-energy.com" <narendra.singh.ext@siemens-energy.com>,

"Gautam, Ranjeet" <ranjeet.gautam@siemens.com>, "Maheshwari, Amrishi" <amrishi.maheshwari@siemens.com>

Date: 30-01-2023 16:16

Subject: RE: Generator Trip Recommendation

External Email | This message was sent from outside of Bajaj Group. Please treat hyperlinks and attachments in this email with caution.

Dear Sir,

Please find below engineering feedback:

1. From a machine's perspective, the Under-frequency operations beyond specified limits of lower frequency and/or increased duration are usually not recommended because of risk of overfluxing of the machine. The impact of overfluxing could be highly detrimental to the machine, particularly the stator core of the generator.
2. Over-frequency is usually limited by Turbine operations and generator just follows turbine tripping. For any overspeed operations beyond specified limits, the critical speeds of the individual equipments/stages in the complete rotor train shall be



analysed thoroughly.

3. Undervoltage operations (beyond specified limits of -5%) at reduced MVA outputs haven't been considered in the statements provided above.

A thorough study may be required to evaluate the specific needs.

Thanks & regards,  
Sandeep Hooda

---

**From:** R. N. Bedi <[rnbedi.ltp@lpgcl.com](mailto:rnbedi.ltp@lpgcl.com)>

**Sent:** Friday, January 13, 2023, 12:28

**To:** Anugonda, Ramesh (RC-IN SE GS-SV SOP FS-LST&LGT) <[anugonda.ramesh@siemens.com](mailto:anugonda.ramesh@siemens.com)>; Ramanujalu, Suresh (RC-IN SE GS-SV SOP FS-LST&LGT) <[ramanujalu.suresh@siemens.com](mailto:ramanujalu.suresh@siemens.com)>

**Cc:** Alhad Narayan Sar <[ansar.ltp@lpgcl.com](mailto:ansar.ltp@lpgcl.com)>; Manoj Mehta <[manojm.ltp@lpgcl.com](mailto:manojm.ltp@lpgcl.com)>; Hooda, Sandeep (RC-IN SE GS-SV S) <[sandeep.hooda@siemens.com](mailto:sandeep.hooda@siemens.com)>

**Subject:** Generator Trip Recommendation

Dear Sir

We at Lalitpur are dispatching power to Agra through 2 nos 765KV transmission lines. At Agra substation, UPPTCL/SLDC want to implement Islanding scheme such that our LPGCL generators will be islanded with the emergency loads (identified at Agra end) based on frequency. For this purpose a study is being done.

In this context we would like to furnish the following information for your kind perusal and need your recommendation considering the safety of Turbine and Generator.

**The present frequency setting in generator at LPGCL :**

**Under Frequency**

If  $F1 < 48.5$  - With a delay of 2 Seconds Alarm will appear

If  $F2 < 47.5$  - Class C protection of Generator will operate with a time delay of 3 Seconds. (All running machines will be isolated from grid) .

If  $F2 < 47.5$  - Class A1 protection of Generator will operate with a time delay of 5 Seconds. ( All running machines will trip)

**Over Frequency**

$F > 51.5$  - Turbine will trip With a delay of 30 Seconds. i.e When the frequency is more than 51.5HZ then trip command is issued to Turbine with a delay of 30 secs . Then the generator trips on turbine tripping.

The instantaneous tripping (Over speed tripping) of Turbine is set at 3300 RPM.

With respect to the suggested Islanding operation of LPGCL generators as stated above, LPGCL seek your recommendation for the following:

1. Is it possible to set the Under frequency below 47.5Hz? if yes then what should be the minimum frequency value.
2. If it is not recommended to go below 47.5Hz then what should the maximum time delay to remain at 47.5Hz.
3. Is it possible to set the Over frequency above 51.5Hz? if yes then what should be the maximum frequency value.
4. If it is not recommended to go above 51.5Hz then what should the maximum time delay to remain at 51.5Hz

In view the above, you are requested to look into the above requirement and suggest your recommendation considering the V/F regime , the designed frequency range etc of machines to ensure safe operation.

**Regards**

**Rudra Narayan Bedi**

President& Head Maintenance

[mbedi.ltp@lpgcl.com](mailto:mbedi.ltp@lpgcl.com)

Lalitpur Power Generation Company Limited

Village Mirchwara Burogaon,

Tehsil Mehrauni, Lalitpur -284 123

Uttar Pradesh

Mob:+91-9151897307

Office:+91-5176272257

[www.lpgcl.com](http://www.lpgcl.com)

---

**SE (R&A)** <sera@upslcd.org>

To: smart.saxena@gmail.com, director\_op <director\_op@upptcl.org>

Wed, Feb 1, 2023 at 11:32 AM

[Quoted text hidden]

--

**Regards**

**Superintending Engineer (R&A)**

**UPSLDC ,Vibhuti Khand,**

**Gomtinagar, Luckow.**

## Fwd: Regarding modifications in Agra Islanding

1 message

**Director(Operation) UPPTCL** <director\_op@upptcl.org>  
To: "Superintending Engineer (R&A)" <sera@upslcdc.org>

Thu, Sep 7, 2023 at 12:13 PM

----- Forwarded message -----

From: **Sreedevi J** <sreedevi@cpri.in>  
Date: Wed, Sep 6, 2023, 12:16  
Subject: Regarding modifications in Agra Islanding  
To: <setagra@upptcl.org>, <directorslcdc@upslcdc.org>, <director\_op@upptcl.org>  
Cc: <dixit.rajat@gov.in>, Venkatesh Donthula <venkyd@cpri.in>

**From:** Sreedevi J [mailto:sreedevi@cpri.in]  
**Sent:** 06 September 2023 11:15 AM  
**To:** 'setagra@upptcl.org'; 'directorslcdc@upslcdc.org'; 'director\_op@upptcl.org'  
**Cc:** 'dixit.rajat@gov.in'; 'sreedevi@cpri.in' <sreedevi@cpri.in>; 'Venkatesh Donthula' <venkyd@cpri.in>  
**Subject:** FW: Re: Regarding modifications in Agra Islanding

प्रिय महोदय/महोदया / Dear Sir/Madam,

सीपीआरआई की ओर से शुभकामनाएँ /Greetings from CPRI !!!

**CPRI was directed to redo the case 11 and CASE 12 by merging UFLS Stage 2 and Stage 3 to UFLS Stage 2, in the online meeting to discuss Lucknow- Unchahar Islanding Scheme and Agra-Lalitpur Islanding on 2/8/2023**

The results are as follows:

Cases 11 and 12 are repeated with some modifications.

UFLS Stage 2 and Stage 3 are merged as UFLS Stage 2. Higher amounts of loads are shed in Stage -2.

However, the duration of generator operation below 47.5 Hz in Case 12 (worst case scenario) has improved marginally with these modifications.

Earlier it was around 2.1s, now it is 1.9s. It is still below the plant setting of generator tripping i.e. 3s.

Increasing load shedding in Stage-1 may cause unnecessary shedding of too many loads in cases where the frequency goes just below 47.6 Hz.

Case 12 may be a rare case when loads are maximum and generators are working at minimum power output.

To increase the safety factor for the rare case (Case 12), we should not trip unnecessary loads for most likely cases.

In summary, UFLS Stage -2 and Stage -3 can be merged.

Minor modifications in the OFGT scheme is required which is also given in the attached file.

Simulation results for other cases will remain unchanged, hence not done.

डॉ. जे.श्रीदेवी/ Dr. J.Sreedevi

संयुक्त निदेशक एवं प्रभाग प्रमुख/ Joint Director & Head of Division

विद्युत प्रणाली प्रभाग/ Power Systems Division

केंद्रीय विद्युत अनुसंधान संस्थान/Central Power Research Institute

पी.बी.नंबर: 8066, सदाशिवनगर/P.B.No: 8066, Sadashivanagar

बैंगलोर 560 080 कार्यालय

फ़ोन: (080)22072445 मोबाइल +91 9449074684

ईमेल: [sreedevi@cpri.in](mailto:sreedevi@cpri.in)

Best Regards,

Dr. J.Sreedevi

Joint Director & Head of Division

Power Systems Division

Central Power Research Institute,

**P.B.No:** 8066, Sadashivanagar,

Bangalore 560 080

Office Ph: (080)22072445

Mobile +91 9449074684

Email: [sreedevi@cpri.in](mailto:sreedevi@cpri.in)



**Minutes of the Meeting held on 2/8/2023 to discuss  
implementation of the Islanding scheme in UP-reg**

I/31336/2023



भारत सरकार

Government of India

विद्युत मंत्रालय

Ministry of Power

उत्तर क्षेत्रीय विद्युत समिति

Northern Regional Power Committee

विषय: Minutes of the meeting held on 02.08.2023 to discuss implementation of Islanding Scheme in UP-reg.

Please find attached minutes of the meeting held on 02.08.2023 to discuss implementation of Islanding Scheme in UP.

This issues with approval of MS, NRPC.

संलग्नक: यथोपरि

Signed by Anzum Parwej  
Date: 31-10-2023 17:36:41  
Reason: Approved

(अंजुम परवेज)

अधीक्षण अभियंता (प्रणाली अध्ययन)

प्रति :

1. जी.एम, उत्तर क्षेत्रीय भार प्रेषण केंद्र, नई दिल्ली
2. मुख्य अभियंता पी.एस.ओ , उत्तर प्रदेश राज्य भार प्रेषण केन्द्र, लखनऊ
3. निदेशक (ऑपरेशन), उत्तर प्रदेश पावर ट्रांसमिशन कॉर्पोरेशन लिमिटेड, लखनऊ
4. एनटीपीसी ऊंचाहार से संबंधित प्रतिनिधि
5. पावरग्रिड एनआर-3 से संबंधित प्रतिनिधि
6. LPGCL से संबंधित प्रतिनिधि
7. CPRI से संबंधित प्रतिनिधि

**Meeting on Unchahar and Agra Islanding Scheme held on 02.08.2023**

Member Secretary, NRPC welcomed participants from NRPC, UPPTCL, UPSLDC, GENCOs, NRLDC, CPRI and POWERGRID.

1. The meeting started with representative from UPPTCL intimating the forum that Unchahar Islanding Scheme is expected to be functional by 30<sup>th</sup> September, 2023.
2. In case of Unchahar Islanding Scheme, UFRs have to be installed at NTPC Unchahar and at four substations of PGCIL in addition to substations of UPPTCL. Regarding UFRs at NTPC Unchahar and substations of PGCIL, it was decided that UFRs shall be procured and commissioned by UPPTCL while maintenance and testing shall be done by respective agencies.
3. Representative from UPSLDC requested that as UFR stages has been shifted upward by 0.2Hz, therefore islanding trigger frequency may also be increased by 0.2Hz that is from 47.9Hz to 48.1Hz. To which, General Manager, NRLDC replied that there should be sufficient difference between last stage of UFLS (48.8Hz) and Island triggering frequency of 47.9Hz so that we can revive grid even after frequency falls below 48.8Hz. Therefore submission of UPSLDC to increase the Island triggering frequency was ruled out.
4. Representative from UPSLDC gave presentation on study report submitted by M/s CPRI. Summary of the presentation on the said report is as follows:-
  - I. M/s CPRI conducted dynamic studies on 18 Load-Generation Scenario.
  - II. As per study, several measures need to be taken to ensure Load-Generation Balance (frequency stability) depending upon the load and generation of Island. These measures are Under Frequency Load shedding (UFLS), Over Frequency Generation Tripping (OFGT), Over Frequency Load Reconnection (OFLR).
  - III. In some of the cases, generators are required to operate below technical minimum.
  - IV. In case No.-12, as per the study, frequency goes below 47.5Hz. for 2sec (under frequency tripping of generator is 47.5Hz with 3 sec delay). As per report, it is recommended to increase the same by 5 sec. or instantaneous tripping at 46.5Hz. Reply of M/s LPGCL to this is attached as annexure.
  - V. It was also recommended by M/s CPRI that governor should respond over a frequency range of -6% to +5 % (47-52.5Hz). However representative from M/s LPGCL intimated that OEM has recommended for -5% to +3% (47.5Hz-51.5Hz).

I/31336/2023

- VI. Feasibility of Island with one unit of Lalitpur TPS is ruled out as per report submitted by M/s CPRI.
5. Based on the discussion on draft report submitted by M/s CPRI following decision were taken:-
- I. M/s CPRI was requested to explore the possibility of merging UFLS stages so that frequency does not fall below 47.5Hz that is Under Frequency Setting of generator. As there is a house load operation facility is available at Lalitpur TPS, therefore decision on whether to go to house load operation must be taken before frequency hits 47.5Hz.
  - II. M/s CPRI will also provide details of OFGT (Over Frequency Generator Tripping) relays available in market with algorithm as mentioned in report.

**Annexure:-**

- I. Presentation
- II. Draft report
- III. LPGCL comment on changes in generator setting.
- IV. M/s CPRI reply on comments on Draft report.
- V. Reply of M/s CPRI on issues raised in special meeting held on 02.08.2023.



**The modified results of CASE 11 and CASE 12  
and  
OFGT Relay Suppliers**

## Sreedevi J

---

**From:** Sreedevi J <sreedevi@cpri.in>  
**Sent:** 06 September 2023 12:04 PM  
**To:** 'setagra@upptcl.org'; 'directorsldc@upslcd.org'; 'director\_op@upptcl.org'  
**Cc:** 'dixit.rajat@gov.in'; 'Venkatesh Donthula'  
**Subject:** Regarding modifications in Agra Islanding  
**Attachments:** results of CASE11 and CASE12.docx

**From:** Sreedevi J [mailto:sreedevi@cpri.in]  
**Sent:** 06 September 2023 11:15 AM  
**To:** 'setagra@upptcl.org'; 'directorsldc@upslcd.org'; 'director\_op@upptcl.org'  
**Cc:** 'dixit.rajat@gov.in'; 'sreedevi@cpri.in' <sreedevi@cpri.in>; 'Venkatesh Donthula' <venkyd@cpri.in>  
**Subject:** FW: Re: Regarding modifications in Agra Islanding

प्रिय महोदय/महोदया / Dear Sir/Madam,  
सीपीआरआई की ओर से शुभकामनाएँ /Greetings from CPRI !!!

**CPRI was directed to redo the case 11 and CASE 12 by merging UFLS Stage 2 and Stage 3 to UFLS Stage 2, in the online meeting to discuss Lucknow- Unchahar Islanding Scheme and Agra-Lalitpur Islanding on 2/8/2023**

The results are as follows:

Cases 11 and 12 are repeated with some modifications.  
UFLS Stage 2 and Stage 3 are merged as UFLS Stage 2. Higher amounts of loads are shed in Stage -2. However, the duration of generator operation below 47.5 Hz in Case 12 (worst case scenario) has improved marginally with these modifications.  
Earlier it was around 2.1s, now it is 1.9s. It is still below the plant setting of generator tripping i.e. 3s.

Increasing load shedding in Stage-1 may cause unnecessary shedding of too many loads in cases where the frequency goes just below 47.6 Hz.  
Case 12 may be a rare case when loads are maximum and generators are working at minimum power output. To increase the safety factor for the rare case (Case 12), we should not trip unnecessary loads for most likely cases.

In summary, UFLS Stage -2 and Stage -3 can be merged.  
Minor modifications in the OFGT scheme is required which is also given in the attached file.  
Simulation results for other cases will remain unchanged, hence not done.

डॉ. जे.श्रीदेवी / Dr. J.Sreedevi  
संयुक्त निदेशक एवं प्रभाग प्रमुख / Joint Director & Head of Division  
विद्युत प्रणाली प्रभाग / Power Systems Division  
केंद्रीय विद्युत अनुसंधान संस्थान / Central Power Research Institute  
पी.बी.नंबर: 8066, सदाशिवनगर / P.B.No: 8066, Sadashivanagar  
बैंगलोर 560 080 कार्यालय  
फ़ोन: (080)22072445 मोबाइल +91 9449074684  
ईमेल: [sreedevi@cpri.in](mailto:sreedevi@cpri.in)

## Case 11: Peak Load-Two Generators- Average Initial Generation

This case study presents simulation results for islanding event during the following condition:

Number of Generators ON before Islanding = 2

Initial Power Output of Generators =  $460 \times 2 = 920$  MW (Average Generation)

Load in the Island = 1337 MW (Peak Load)

Description: A large generator in the external area was tripped at 1s, which results in increase in electrical power of the Lalitpur generators and system wide frequency fall just after the generator tripping event. Mechanical power increases during the frequency fall due to droop control. Islanding happens at 47.9 Hz. Total electrical load is higher than the mechanical power. Therefore, frequency begins to fall. As the frequency falls below 47.6 Hz and 47.3 Hz, UFLS-stage 1 and stage-2 occur to restrict further fall in frequency. Frequency is restored due to reduction in electrical loads. As the frequency increases beyond 50.5 Hz, loads are reconnected at buses 153305 and 153315 which reduces the deviation between generation and loads in the island. Electrical power output, frequency and mechanical power are shown in Fig. 1. Portion of the frequency and electrical power output waveforms are zoomed in Fig. 2 and Fig. 3. The duration of generator operation below 47.5 Hz is approx. 1.2s which is less than the generator tripping time used by the plant operators.

UFLS Stage 2: UFLS Stage 2 and Stage 3 of the original report are merged in UFLS-Stage 2 here.

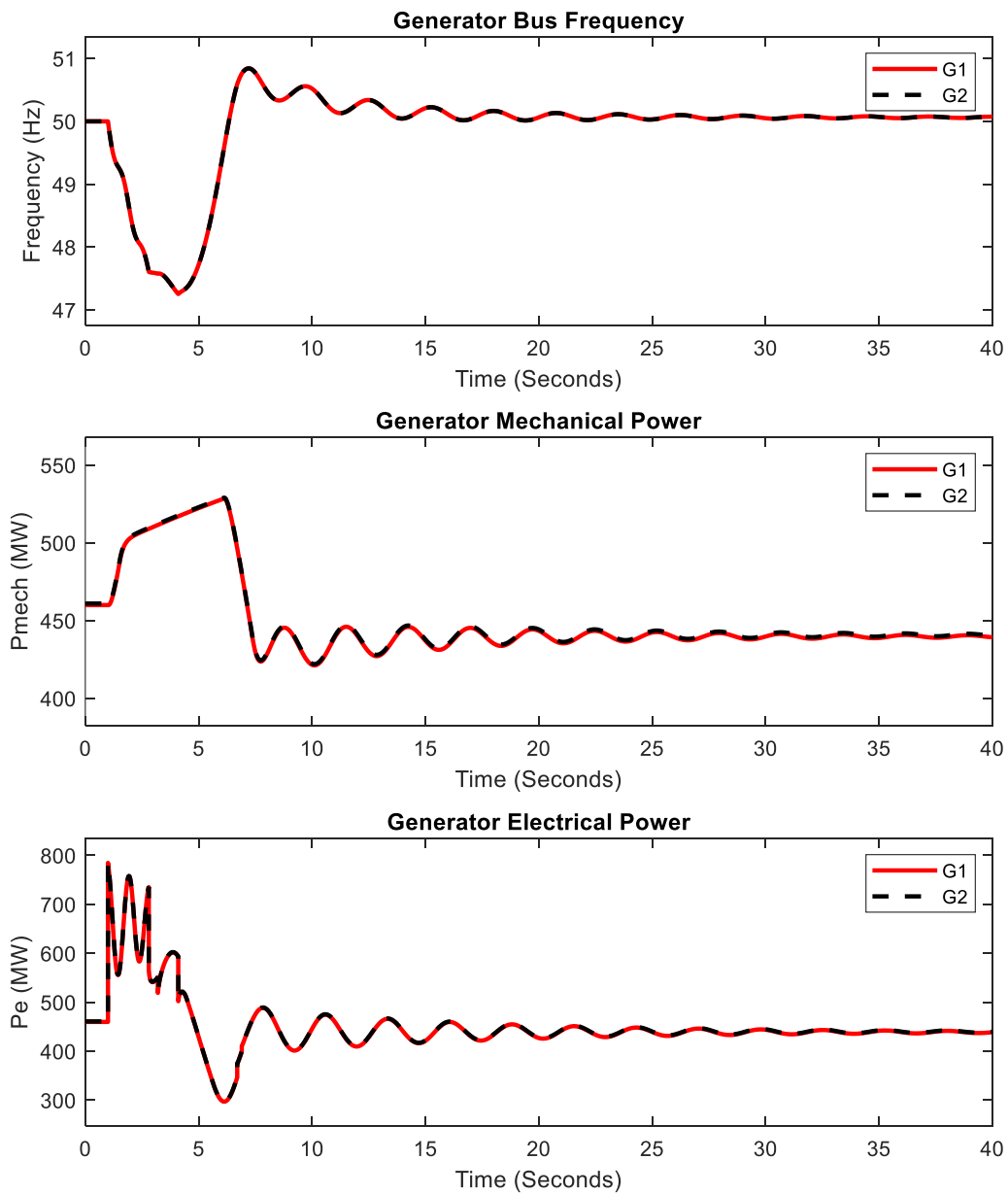

Fig.1. Variations in frequency, mechanical power and electrical power in case of islanding during peak load, average initial generation with two generators connected to the grid. UFLS was done to stabilize the frequency in the island. Over frequency load reconnection was done to reduce the difference between load and generation.

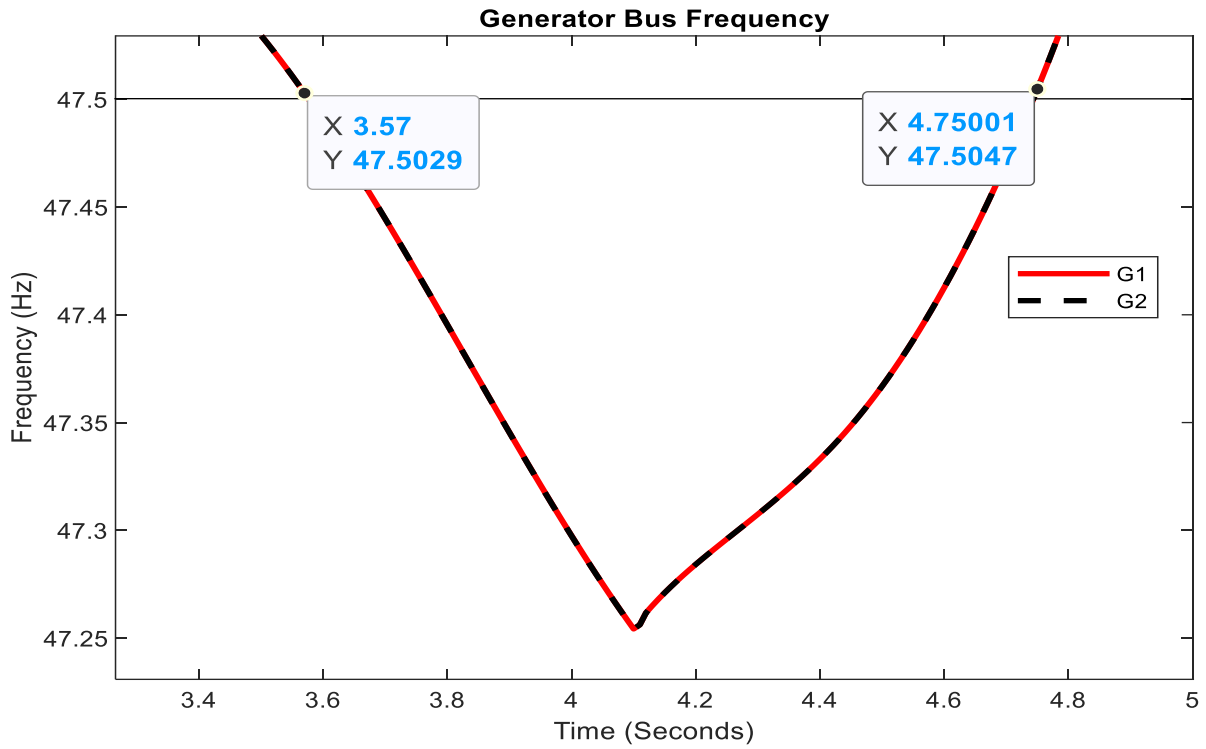

Fig.2. Zoomed portion of the frequency waveform to highlight the impact of load shedding

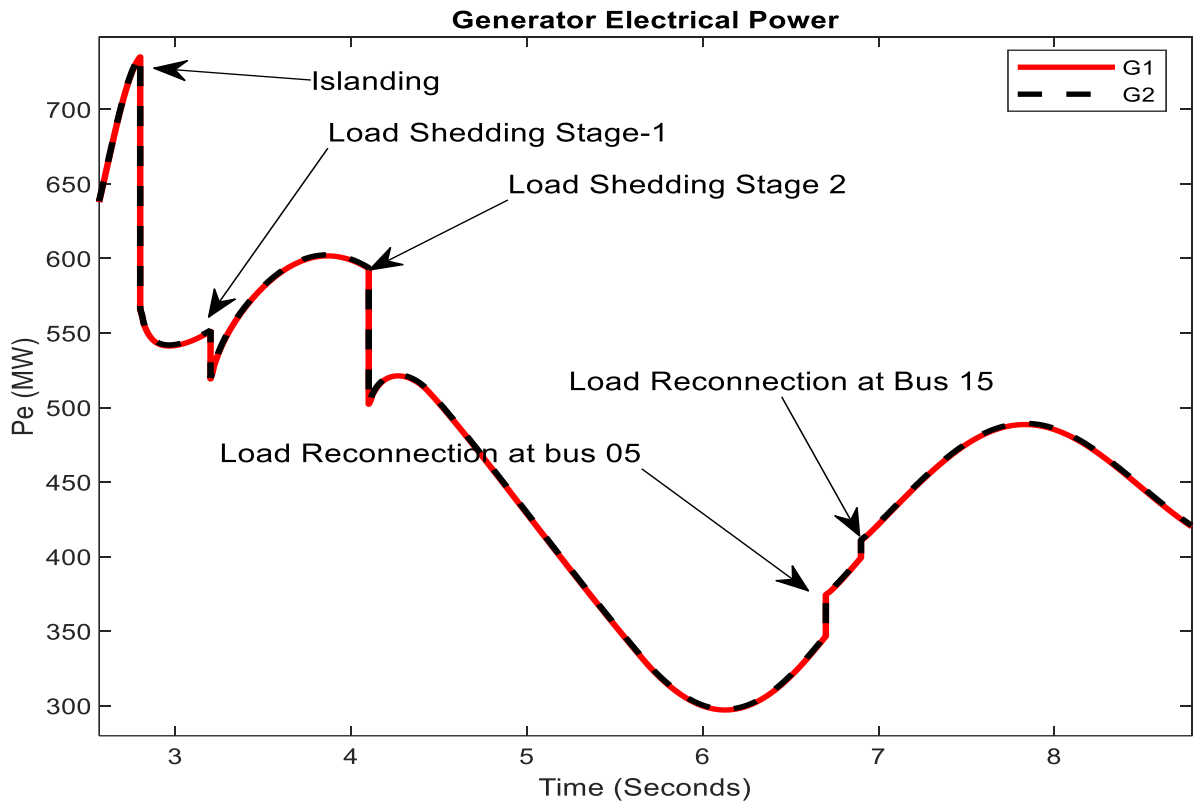

Fig.3. Zoomed portion of electrical power waveform to highlight the impact of load shedding on electrical power output.

## **Case 12: Peak Load-Two Generators- Minimum Initial Generation**

This case study presents simulation results for islanding event during the following condition:

Number of Generators ON before Islanding = 2

Initial Power Output of Generators =  $330 \times 2 = 660$  MW (Minimum Generation)

Load in the Island = 1337 MW (Peak Load)

Description: A large generator in the external area was tripped at 1s, which results in increase in electrical power of the Lalitpur generators and system wide frequency fall just after the generator tripping event. Mechanical power increases during the frequency fall due to droop control. Islanding happens at 47.9 Hz. Total electrical load is higher than the mechanical power. Therefore, frequency begins to fall. As the frequency falls below 47.6 Hz and 47.3 Hz, UFLS-stage 1 and stage-2 occur to restrict further fall in frequency. Frequency is restored due to reduction in electrical loads. Electrical power output, frequency and mechanical power are shown in Fig. 4. Portion of the frequency and electrical power output waveforms are zoomed in Fig. 5 and Fig. 6. The duration of generator operation below 47.5 Hz is approx. 1.9s which is less than the generator tripping time used by the plant operators.

UFLS Stage 2: UFLS Stage 2 and Stage 3 of the original report are merged in UFLS-Stage 2 here.

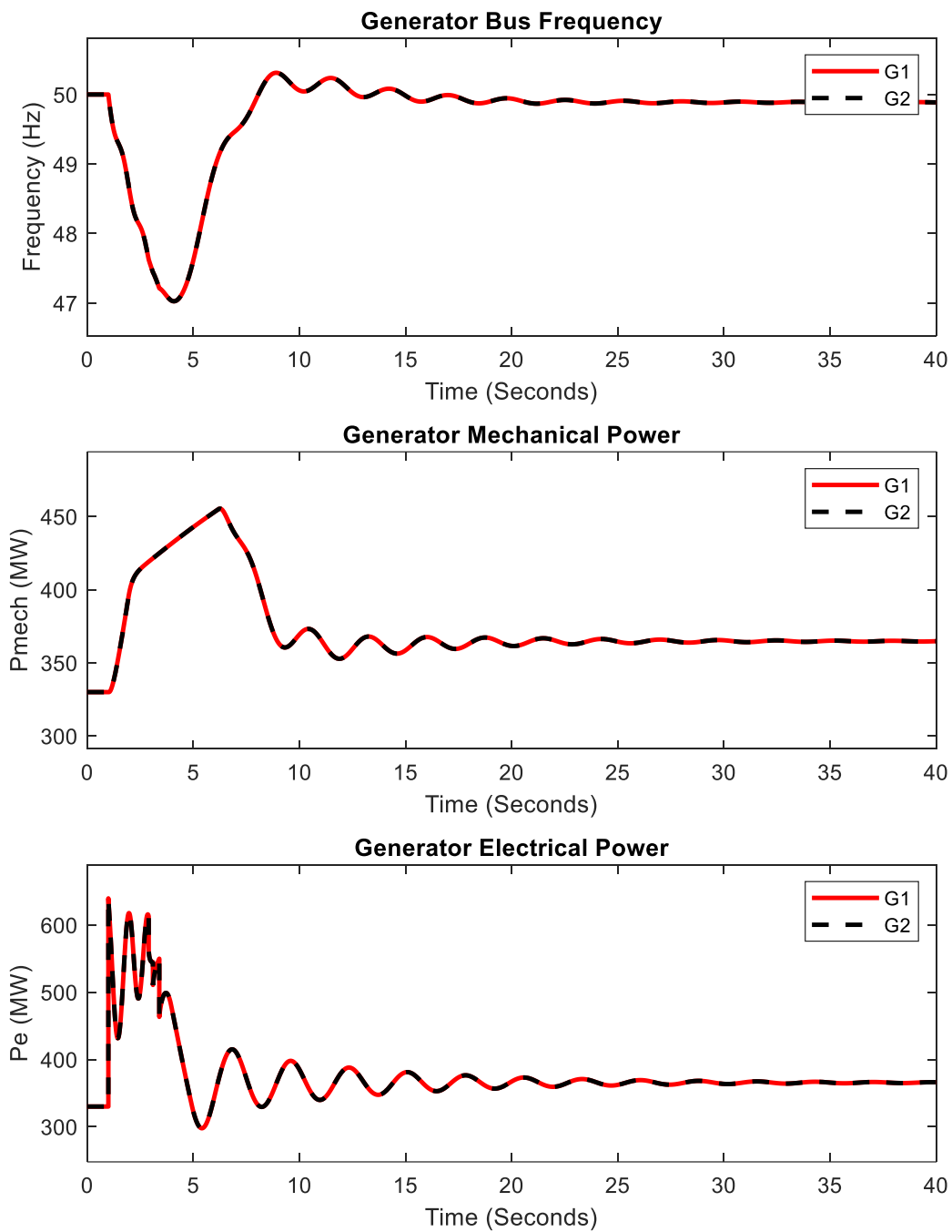

Fig.4. Variations in frequency, mechanical power and electrical power in case of islanding during peak load, average initial generation with two generators connected to the grid. UFLS was done to stabilize the frequency in the island.

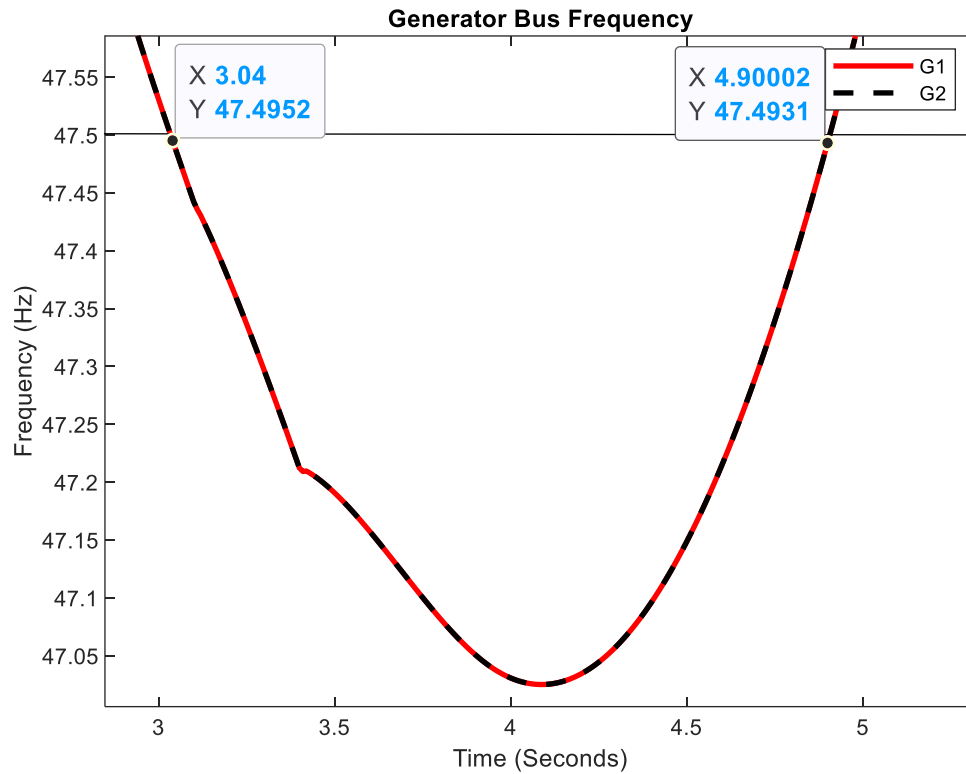

Fig.5. Zoomed portion of frequency waveform to highlight the effect of UFLS on frequency response

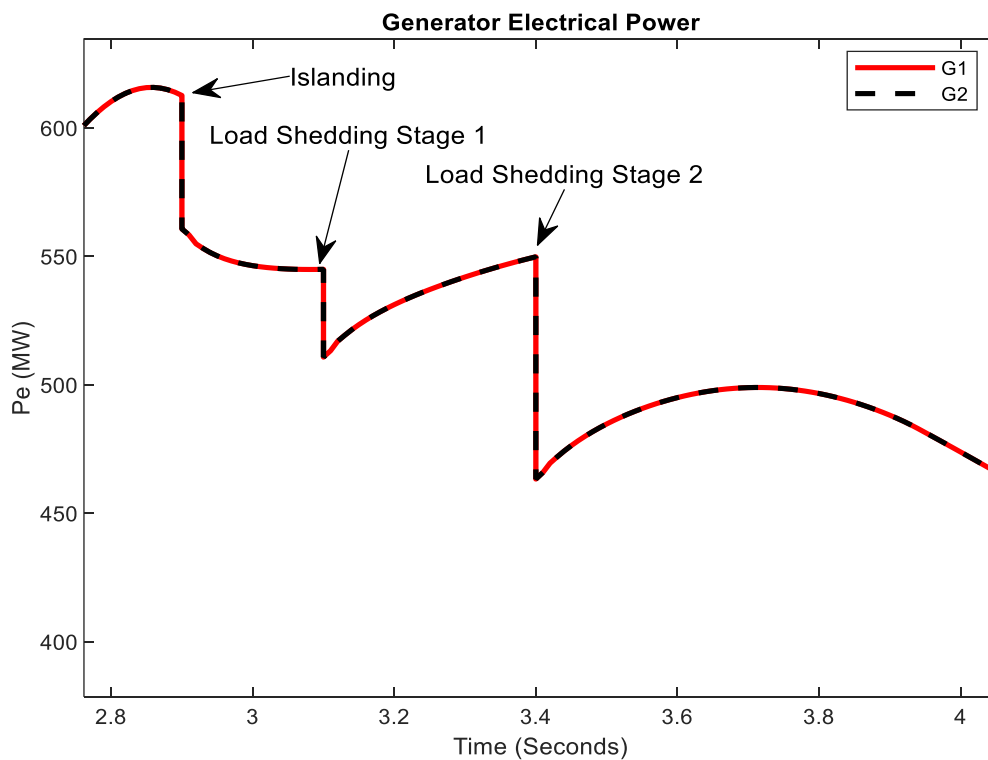

Fig. 6. Zoomed portion of electrical power waveform to highlight the effect of UFLS on electrical power



**Changes required in OFGT Scheme if UFLS Stage 2 and Stage 3 are merged:** Nadir frequency is measured and fOFGT is set as a function of nadir frequency. Rest part of the over frequency generator tripping (OFGT) scheme remain unchanged.

No UFLS	If fnadir > 47.65:	fOFGT = 51.0
UFLS-Stage 1 happened	If fnadir < 47.65 and fnadir > 47.35:	fOFGT = 51.3
UFLS-Stage 2 happened	If fnadir < 47.35:	fOFGT = 52.0

OFGT (Over Frequency Generator Tripping) relays available in market with algorithm as mentioned in report:

The relay makes and their models that operate at the set frequency with time delay are given below. The algorithm has to be customised by the supplier at the time of supply.

- GE's MiCOM P343
- Schneider Electric's ANSI 81
- ABB's REG 615

Una District Transmission Plan

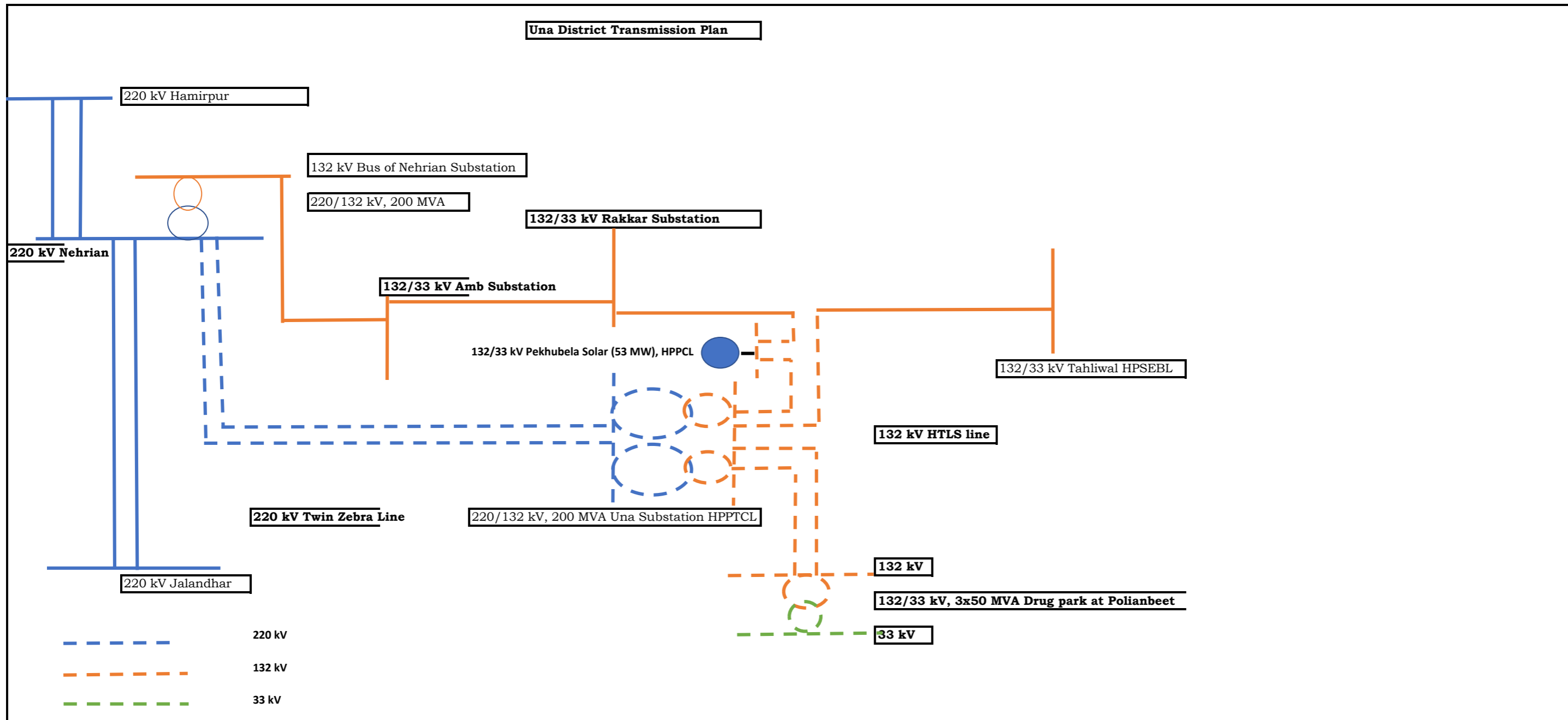

I/31615/2023

Annexure-XI



भारत सरकार

**Government of India**

विद्युत मंत्रालय

**Ministry of Power**

केन्द्रीय विद्युत प्राधिकरण

**Central Electricity Authority**

विद्युत प्रणाली योजना एवं मूल्यांकन-I प्रभाग

**Power System Planning & Appraisal-I Division**

सेवा में / To

1. COO (CTUIL), Saudamini, Plot No. 2, Sector - 29, Gurugram-122001
2. CEO, POSOCO, B-9, Qutab Institutional Area, Katwaria Sarai, New Delhi-110010
3. Director, HPPTCL, Himfed Bhawan, Panjari, Shimla-171005

**विषय/Subject: Meeting to discuss HPPTCL proposal for Construction of a 220/132 kV, 200 MVA substation nearby Una, Himachal Pradesh - regd**

महोदय/Sir,

A meeting through VC was held on 02.11.2023 to discuss HPPTCL's proposal for Construction of a 220/132 kV, 200 MVA substation nearby Una, Himachal Pradesh under intrastate transmission system.

The Minutes of the meeting are attached herewith.

Encl: As above

भवदीय / Yours faithfully,

(नितिन देसवाल / Nitin Deswal)

उप निदेशक/Deputy Director

प्रतिलिपि/ Copy to -

1. SA to Member (PS), CEA

I/31615/2023

**Minutes of the meeting to discuss HPPTCL's proposal for Construction of a 220/132 kV, 200 MVA substation nearby Una, Himachal Pradesh**

List of participants is attached at **Annexure-I**.

**Background**

HPPTCL vide letter dated 15.07.2023 submitted a proposal for establishment of a 200/132 kV substation near Una, Himachal Pradesh. The following intra-state transmission system has been proposed by HPPTCL:

- (i) Establishment of 220/132 kV, 200 MVA sub-station near Una, Himachal Pradesh
- (ii) Nehrian (220/132 kV) – Una (220/132 kV) 220 kV D/c line

Presently, both circuits of Hamirpur – Jalandhar (PG) 220 kV D/c line are LILOed at Nehrian (220/132 kV, 200 MVA) S/s. As the elements in the proposal are intra-state elements incidental to ISTS; therefore, HPPTCL has sought approval of CEA.

The proposal along with studies submitted by HPPTCL was forwarded to CTUIL and Grid India seeking their observations and comments on the same. CTUIL and Grid India have furnished their observations. The meeting has been proposed for further deliberations on the proposal.

**Deliberations in the meeting**

- HPPTCL elucidated the intra-state proposal and stated that the existing EHV network supplying power to Una and surrounding area is saturated and needs to be supplemented immediately keeping in view the establishment of proposed Bulk Drug Park (Project of National Importance) having projected demand of 120 MVA by 2026-27 and to provide reliable power to existing and future consumers in Una area. Presently, 132/33 kV Rakkar Substation & 132/33 kV Tahliwal Substation together are serving commercial load of Una City and industrial & Domestic load of Tahliwal industrial area respectively. The load being catered is around 100 MVA and entire load is being served by 132 kV S/c link from Amb substation of HPSEBL. Presently the 132 kV link has reached its maximum loading and in the event of its outage, the entire area has to face power disruptions. Therefore, additional source of supply is required to serve the increased load envisaged in Una district.
- HPPTCL added that as an immediate measure, HPPTCL would be constructing 220/132 kV, 80/100 MVA Sub-station at Tahliwal (Distt. Una in Himachal Pradesh) by S/c LILO of 220 kV D/C Bhakra - Jamalpur D/C line of BBMB (with provision of SPS to restrict drawl at 50 MVA and to ensure no drawl of power from Jamalpur side in case of outage of Bhakhra - Tahliwal circuit). Further, for the long-term plan of providing 120 MVA power to the proposed Bulk Drug Park and to ensure reliable power supply in the area, establishment of 220/132 kV, 2x100 MVA Substation nearby Una by 220 kV D/C (Twin Zebra) line from 220/132 Nehrian Substation to Una has been proposed. HPPTCL stated that the above proposal shall be part of intrastate transmission network and HPPTCL agreed to any required system strengthening identified by POSOCO and CTUIL.
- Grid India stated that ICT loadings (2 x 315 MVA + 500 MVA, 400/220 kV) at Jalandhar (PG) has regularly crossed 800 MW and as per load flow studies, 17% of load is getting transferred

I/31615/2023

to 315 MVA ICTs during tripping of 500 MVA ICT. Therefore, with the proposed 200 MVA substation, there would be requirement for additional ICT at Jalandhar or augmentation of existing 315 MVA ICT to 500 MVA for 'N-1' compliance. Alternatively, if further incremental load is to be fed by 220 kV Hamirpur - Nehrian ckts, reconductoring of these circuits would be needed to cater to increased load at 220 kV Nehrian substation.

- CTUIL stated that proposal seems fine; however, in evening peak scenario (Monsoon season), loading of 220 kV Nehrian- Hamirpur D/c line is marginally higher (~200 MW) in 'N-1' contingency condition with the proposed load at new 220/132 kV Una S/s. Therefore, loading of 220 kV Nehrian - Hamirpur D/c line need to be observed in real time with implementation of proposed intra state system (being implemented by HPPTCL), considering actual load growth in Una area, so that measures may be taken for reconfiguration/diverting the load by HPPTCL or strengthening scheme may be planned to meet proposed demand of Una area.
- Regarding query about the issue of critical loading of ICTs at Jalandhar (PG) and operational constraints thereof, Grid India informed that the loadings of the ICTs have not yet reached the critical mark; therefore, the issue has not been highlighted in the operational feedback. However, with the proposed drawl from new sub-station in Una and availability of very less margin in 400/220 kV ICTs at Jalandhar (PG), there might be requirement of augmentation of ICTs at 400/220 kV Jalandhar (PG) S/s.
- Regarding availability of space for augmentation at Jalandhar (PG), CTUIL informed that space is not available for additional ICT; however, the existing 315 MVA, 400/220 kV ICTs could be upgraded to 500 MVA, if required.
- Regarding the tentative progression of demand/drawl from proposed Una sub-station, HPPTCL informed that there would be requirement for additional load of 120 MVA progressively by the year 2026-27.
- After further deliberations, the proposal of HPPTCL for establishment of 220/132 kV, 200 MVA substation nearby Una, Himachal Pradesh, through Una (New) – Nehrian 220 kV D/c line under intrastate transmission system was agreed. Further, with the implementation of above intra-state system, the loadings of 400/220 kV ICTs at Jalandhar (PG), and 220 kV Nehrian - Hamirpur D/c line need to be observed with the progressive increase in demand in Una area so that suitable augmentation measures in ISTS may be planned accordingly, if required.

Meeting ended with thanks to the chair.

\* \* \*

I/31615/2023

Annexure-I**List of Participants**

	<b>Name (Sh/Smt/Ms)</b>	<b>Designation</b>
	<b>CEA</b>	
<b>1</b>	Ishan Sharan	Chief Engineer
<b>2</b>	Manjari Chaturvedi	Director
<b>3</b>	Nitin Deswal	Deputy Director
	<b>CTUIL</b>	
<b>4</b>	Sandeep Kumawat	Ch. Manager
	<b>Grid India</b>	
<b>5</b>	Gaurav Singh	Manager
	<b>HPPTCL</b>	
<b>6</b>	Rajiv Sood	Director
<b>7</b>	Harmanjeet Singh	Dy. Manager

No. 14/02/2021-UR&SI-II-Part(1)(E-258136)  
Government of India  
Ministry of Power  
\*\*\*\*\*

Shram Shakti Bhawan, Rafi Marg  
New Delhi, Dated: 10<sup>th</sup> January, 2024

To

The Chairperson,  
Central Electricity Authority,  
Seva Bhavan, R.K. Puram,  
New Delhi.

**Subject: Mandatory Testing and Certification of Telecom Equipment (MTCTE).**

Sir,

With reference to the subject cited above, I am directed to say that the Department of Telecom vide letter no. 6-6/2021-TC/TEC dated 17.10.2023 has requested to ensure that only MTCTE certified Telecom and Networking products are procured and connected in the Indian Telecom Network as mandated by Indian Telegraph (Amendment) Rules, 2017. It was also requested that regulatory requirement of obtaining MTCTE certification by OEMs/ Importers before sale of notified Telecom & Networking products may also be communicated to Manufacturers/ Sellers, who are supplying / selling such Telecom & Networking products.

2. In this regard, it was also informed that MTCTE certificate for 12 products being connected to Telecom Network/ used for data transfer (such as Router, LAN Switch, Smart Electricity Meters etc.) will become mandatory from 01.04.2024 and for remaining 32 products from 01.01.2024 (list enclosed).

3. In view of the above, it is requested to take all necessary measures in this regard so that the requirement for MTCTE certification can be made mandatory for OEMs/ Importers as per the stipulated timelines. It is further requested to submit a detailed action plan in this regard to this Ministry latest by 12.01.2024.

5. This is issued with the approval of Competent Authority.

Yours faithfully



(Bimlesh Pawar)

Under Secretary (UR&SI-II)

Encl.: As above.

Copy to:

1. CMD, REC
2. CMD, PFC

Also copy to: PPS to Secretary (Power)/ PSO to Joint Secretary (Distribution)/  
PPS to Dy. Secretary (UR&SI)

डॉ. नीरज मिश्र, भा.प्र.से.  
सचिव

DR. NEERAJ MITTAL, IAS  
Secretary



भारत सरकार  
संचार मंत्रालय  
दूरसंचार विभाग

GOVERNMENT OF INDIA  
MINISTRY OF COMMUNICATIONS  
DEPARTMENT OF TELECOMMUNICATIONS

**DO. No. 6-6/2021-TC/TEC**  
17<sup>th</sup> October, 2023

Dear *Pankaj,*

This letter pertains to procurement of telecom equipment (that may be procured for projects such as Bharatnet and local state telecom/ IT projects) by the State Governments that need to be MTCTE certified. In this regard, Department of Telecommunications (DoT) has notified the 'Indian Telegraph (Amendment) Rules, 2017' vide Gazette Notification No G.S.R. 1131(E) dated 5<sup>th</sup> September 2017 on 'Testing and Certification of Telegraph.' The said notification mandates that *any telegraph (telecom) equipment which is used or capable of being used with Indian telecom network, shall have to undergo prior Mandatory Testing & Certification in respect of parameters as determined by the telegraph authority from time to time.* The above rules have come into force on 1<sup>st</sup> October 2018. (Copy of Gazette Notification dated 5<sup>th</sup> September 2017 is available on DoT website <https://dot.gov.in/act-rules>.)

2. The objective of said mandatory testing and certification is to ensure:
- That any Telecom Equipment does not degrade performance of existing network to which it is connected;
  - Safety of the end-users;
  - Protection of users and general public by ensuring that radio frequency emissions from equipment do not exceed prescribed standards;
  - That telecom equipment complies with the relevant national and international regulatory standards and requirements and
  - Security of Telecom Network/ Systems.

3. In pursuance to above Rules, Telecommunication Engineering Centre (TEC), the technical body under Department of Telecommunications (DoT) is administrating the implementation of Mandatory Testing & Certification of Telecom Equipment (MTCTE) Scheme. The specific Telecom & Networking product covered under MTCTE scheme is notified by TEC from time to time on MTCTE website (<https://www.mtcte.tec.gov.in>) indicating certification enforcement date.

4. As on date, MTCTE certificate is mandatory for Telecom & Networking product such as Cordless/CLIP/Landline Phone, PABX, FTTH OLT/ONT/ONU used for broadband services etc. prior to their sale/use in India (Annexure-A).

Contd....2/-



Further, from 1st January 2024, MTCTE certificate for more products (such as Router, LAN Switch, wifi Access Modems, IoT gateway, Tracking Device, Smart electricity meter, End Point Device for Environmental Monitoring, Optical Fibre, Optical Fibre Cable, Walkie-talkie etc.) will become mandatory as being connected to Telecom network/used for data transfer. The complete list of such notified Telecom product is available on MTCTE website.

Presently, the MTCTE certificate has been issued to more than 3,000 Telecom & Networking product models. The details of MTCTE certified products are available on website (<https://www.mtcte.tec.gov.in> > certified equipment).

5. In view of the above, it is requested to kindly inform about Mandatory Testing & Certification of notified Telecom equipment to IT Department and other concerned departments/Autonomous bodies/attached offices etc., so as to ensure that only MTCTE certified Telecom & Networking products are procured and connected in the Indian Telecom Network as mandated by Indian Telegraph (Amendment) Rules, 2017. Further, the regulatory requirement of obtaining MTCTE certification by OEMs/Importers before sale of notified Telecom & Networking products may also be communicated to Manufacturers/Sellers, who are supplying/selling such Telecom & Networking products.

6. In case of any further details or clarification in this regard, Director (TC-1), TEC, New Delhi may be contacted on e-mail id: [dirta.tec@gov.in](mailto:dirta.tec@gov.in).

Yours sincerely

Encl: as above

  
(Neeraj Mittal)

**Shri Pankaj Agarwal**  
Secretary  
Ministry of Power  
Room No.205, Shramshakti Bhawan  
Rafi Marg  
New Delhi - 110 001.

**Annexure-A****List of Notified Telecom & Networking Products under Mandatory Testing & Certification of Telecom Equipment (MTCTE)**

S.N	Essential Requirement/ Product Name	Main Product Variants	MTCTE Phase	Mandatory date of certification of product under MTCTE
1.	2- Wire Telephone Equipment	2-Line Feature Phone; CLIP (Calling Line Identification Presentation) Phone; Electronic Telephone Instrument; Executive Telephone Systems; Key Telephone Systems; Key Telephone Systems with proprietary interface;	Phase-1	1st October, 2019
2.	G3 Fax Machine	FAX machine with & without handset	Phase-1	1st October, 2019
3.	Modem	V.90 or V.92 or V.21 to V.34 Modem	Phase-1	1st October, 2019
4.	Cordless Telephone	Cordless Telephone	Phase-1	1st October, 2019
5.	ISDN (Integrated Services Digital Network) Customer Premises Equipment	ISDN Gateway; ISDN Terminal;	Phase-1	1st October, 2019
6.	Private Automatic Branch Exchange	Private Automatic Branch Exchange	Phase-1	1st October, 2019
7.	PON (Passive Optical Network) Family of Broadband Equipment	PON OLT (Optical Line Terminal); PON ONT (Optical Network Terminal); PON ONU (Optical Network Unit);	Phase-2	1st October, 2020
8.	Feedback Device	Feedback Device	Phase-2	1st October, 2020
9.	Transmission Terminal Equipment	Multiplexing Equipment; SDH (Synchronous Digital Hierarchy) Equipment	Phase-2	1st October, 2020

**Note 1:** The complete list/details of MTCTE notified products with enforcement date are available on website <https://www.mtcte.tec.gov.in>

**Note 2:** The details of MTCTE certified products (make & model) are available on website (<https://www.mtcte.tec.gov.in> > certified equipment)

**Telecommunication Engineering Centre**  
**(Department of Telecommunications)**  
**Khurshid Lal Bhawan, Janpath, New Delhi - 110 001**  
<https://www.tec.gov.in/>

No. 5-2/2021-TC/TEC/185

Dated: 27/12/2023

**Amendment Notification**

**Subject: Extension of mandatory certification date for 12 products (ERs) notified under phase-III & IV of MTCTE by three months i.e. from 01.01.2024 to 01.04.2024 -reg.**

**Ref: No. 5-2/2021-TC/TEC/131 dated 23/06/2023 & no. 5-2/2021-TC/TEC/172 dated 27/09/2023**

In partial modification to this office Notification no. 5-2/2021-TC/TEC/131 dated 23/06/2023 & no. 5-2/2021-TC/TEC/172 dated 27/09/2023, w.r.t. the testing and certification of telecom & networking equipment notified under Phase-III & Phase-IV of MTCTE regime, the following amendments are hereby notified with immediate effect as mentioned below:

- a. Extension of date of mandatory certification of 12 products (ERs) out of 44 products notified under MTCTE phase-III and IV by three months i.e. from 01.01.2024 to 01.04.2024. The list of 12 products is placed at Annexure-I.  
Mandatory date of certification for remaining 32 products (ERs) shall remain unchanged i.e. 01.01.2024. The list of 32 products is placed at Annexure-II.
- b. Extension of last date of acceptance of test reports issued by labs accredited by International Laboratory Accreditation Cooperation (ILAC) signatories from non-border sharing countries by three months for technical parameters only i.e. from 31.12.2023 to 31.03.2024 for the 08 products (ERs) mentioned in Annexure-III.

This issues with the approval of Competent Authority.

  
27/12/2023  
अवधेश सिंह/Avadhesh Singh  
निदेशक (टी०सी०-I)/Director (TC-I)  
Email- [dirta.tec@gov.in](mailto:dirta.tec@gov.in)

Copy to (through email):

- i. PS to Hon' ble MoC, DOT, New Delhi
- ii. PS to Hon'ble MoSC, DOT, New Delhi
- iii. PPS to Secretary (T), DOT, New Delhi
- iv. PPS to Member(S)/ Member(T)/ Member(F)/ DG(Telecom), DOT, New Delhi
- v. Advisor, TEC New Delhi / Sr. DDG, NCCS Bangalore/ CEO, C-DOT
- vi. JS (Customs), CBIC
- vii. AD (IT)/AD (TC), TEC for uploading on TEC/MTCTE website
- viii. Office copy

*Md. Arif*  
*28/12/2023*

**List of 12 products (ERs) under phase-III & IV of MTCTE with  
mandatory certification date as 01.04.2024**

S No	ER/Product	Notified in Phase
1.	Base Station for cellular network	Phase-III
2.	Repeater for Cellular Network	Phase-III
3.	Smart Electricity Meter	Phase-III
4.	SIM	Phase-IV
5.	HF Radio	Phase-IV
6.	Mobile Radio Trunking System	Phase-IV
7.	VHF UHF Radio System Equipment	Phase-IV
8.	PTP PMP Microwave Fixed Radio System	Phase-IV
9.	LAN Switch	Phase-IV
10.	Router	Phase-IV
11.	IP Security Equipment	Phase-IV
12.	Satellite Communication Equipment	Phase-IV

*27/11/2023*  
*27/11/2023*

**List of 32 products (ERs) under phase-III & IV of MTCTE with  
mandatory certification date as 01.01.2024**

S.No	ER/Product	Notified in Phase
1.	Compact Cellular Network	Phase-III
2.	Equipments Operating in 2.4 GHz and 5 GHz Band	Phase-III
3.	IoT Gateway	Phase-III
4.	Tracking Device	Phase-III
5.	End Point Device for Environmental Monitoring	Phase-III
6.	Radio Broadcast Receiver RBR	Phase-IV
7.	Optical Fibre-Single Mode	Phase-IV
8.	Optical Fibre Cable	Phase-IV
9.	DSL Equipments	Phase-IV
10.	Signalling Gateway	Phase-IV
11.	Session Border Controller	Phase-IV
12.	Softswitch	Phase-IV
13.	Media Gateway	Phase-IV
14.	Precision Timing Protocol Grand Master Equipment	Phase-IV
15.	Infiniband Switch	Phase-IV
16.	IP Multimedia Conferencing Equipment	Phase-IV
17.	Conferencing Equipment	Phase-IV
18.	Transmission Terminal Equipment-2 (DWDM, Digital Cross Connect)	Phase-IV
19.	Mobility Management Entity (MME)	Phase-IV
20.	Serving GPRS Support Node (SGSN)/Gateway GPRS Support Node (GGSN)	Phase-IV
21.	Base Station Controller (BSC)/Radio Network Controller (RNC)	Phase-IV
22.	Cell Broadcast Centre (CBC)	Phase-IV
23.	Gateway Mobile Location Centre (GMLC)	Phase-IV
24.	Home Location Register (HLR)/Authentication Centre(AUC)/Home Subscriber Server (HSS)	Phase-IV

*27/11/2023*

25.	Mobile Switching Centre (MSC)/MSC-Server (MSC-S)/ Gateway MSC (GMSC) / Gateway MSC- Server (GMSC-S) including Visitor Location Register (VLR)	Phase-IV
26.	OTA and DM or FOTA	Phase-IV
27.	Service Control Point (SCP)	Phase-IV
28.	Operation Maintenance Support (OMC) / Element Management System (EMS) / Network Management System (NMS) / Operation Support System (OSS)	Phase-IV
29.	Serving Gateway (S-GW) / Packet Gateway (P-GW)	Phase-IV
30.	Short Message Service Centre (SMSC)	Phase-IV
31.	Serving Mobile Location Centre (SMLC) or eSMLC	Phase-IV
32.	Equipment Identity Register (EIR)	Phase-IV

*mae 21 162*  
*27/12/2023*

**List of 08 products (ERs) under phase-III & IV of MTCTE for acceptance of test reports in respect of 'Technical Parameter' up to 31.03.2024 from labs accredited by ILAC signatories from non- border sharing countries**

S. No	ER/Product	Notified in Phase
1.	Base Station for cellular network	Phase-III
2.	Repeater for Cellular Network	Phase-III
3.	Compact Cellular Network	Phase-1 II
4.	SIM	Phase-IV
5.	HF Radio	Phase-IV
6.	VHF UHF Radio System Equipment	Phase-IV
7.	Radio Broadcast Receiver RBR	Phase-IV
8.	Satellite Communication Equipment	Phase-IV

Note: - As on the date of submission of test reports, the validity of test reports/results issued by foreign labs accredited by ILAC signatories from non-border sharing countries for technical parameters only shall be up to two years in respect of the above products (ERs).

\*\*\*\*\*

*Handwritten signature and date:*  
27/12/2023



**Capacity Building programme on  
“International Best Practices in Energy Transition”  
for Constituents of Northern Regional Power Committee  
(NRPC)**

*Proposal Submitted by Member Secretary on  
behalf of Northern Regional Power Committee*

**January 2024**

## Table of Content

SI.No	Chapter	Page
1	About Northern Regional Power Committee	3
2	Summary of Proposal-Format A1	5
3	Detailed Proposal-Format A2	7
4	Summary of DPR-Format A3	11
5	Financial Implication of the Scheme-Format A4	13
6	Brief Details of the Project Appraisal by CTU/STU/RPC- Format A5	14
7	Affidavit –Format A6	15
8	Supplementary Information	16

### 1. ABOUT NORTHERN REGIONAL POWER COMMITTEE

- With an objective to facilitate integrated operation of power system in Northern Region, Government of India, under the provision of Section 2, Subsection 55 of the Electricity Act 2003 vide resolution F.No. 23/21/2021-R&R dated 3<sup>rd</sup> December 2021 (repealed resolution dated. 25.05.2005) published in the Gazette of India has established the Northern Regional Power Committee comprising of states of Delhi, Haryana, Himachal Pradesh, Punjab, Rajasthan, Uttaranchal and Uttar Pradesh and the Union Territories of Chandigarh, Jammu & Kashmir and Ladakh.
- Manpower is posted by Central Electricity Authority (CEA).
- RPCs have been envisioned as self-financed. The expenditure of RPCs is met from contribution collected from constituent members of region.
- Member Secretary is HoD of NRPC Secretariat and is convenor of RPC.

### 2. MEMBERS OF NRPC:

- a.) Member (Grid Operation), Central Electricity Authority (CEA).

- b.) One representative each of Central Generating Companies, Central Transmission Utility (CTU), Central Government owned Transmission Company, National Load Despatch Centre (NLDC) and the Northern Regional Load Despatch Centre (NRLDC).
- c.) From each of the States in the region, the State Generating Company, State Transmission Utility (STU), State Load Despatch Centre (SLDC), one of the State owned distribution companies as nominated by the State Government and one distribution company by alphabetical rotation out of the private distribution companies functioning in the region.
- d.) A representative nominated by the administration of the Union Territory concerned out of the entities engaged in generation/ transmission/ distribution of electricity in the Union Territory.
- e.) A representative each of every generating company (other than central generating companies or State Government owned generating companies) having more than 1000 MW installed capacity in the region.
- f.) A representative of the generating companies having power plants in the region (not covered in (b) to (e) above) by alphabetical rotation.
- g.) A representative of one private transmission licensee, nominated by Central Government, operating the Inter State Transmission System, by alphabetical rotation out of such Transmission Licensee operating in the region.
- h.) One member representing the electricity traders in the region by alphabetical rotation, which have trading volume of more than 500 million units during the previous financial year.
- i.) A representative each of every Nodal Agency appointed by the Government of India for coordinating cross-border power transactions with the countries having electrical inter-connection with the region
- j.) Member Secretary, NRPC – Convenor

### 3. SUB-COMMITTEES OF NRPC

- Technical Co-Ordination Sub-Committee (TCC)
- Operation Co-Ordination Sub-Committee (OCC)
- Protection Sub-Committee (PSC)

- Commercial Sub Committee (CCM)
- Telemetry, SCADA and Telemetry Sub-Committee (TeST)
- Other Sub Committees as decided as per requirement

#### 4. FUNCTION OF NRPC

Function of NRPC is to facilitate the stability and smooth operation of the integrated grid and economy & efficiency in the operation of power system in the region. NRPC is carrying out following functions: -

1. To undertake Regional Level operation analysis for improving grid performance.
2. To facilitate inter-state/inter-regional transfer of power.
3. To facilitate all functions of planning relating to inter-state/ intra-state transmission system with CTU/STU.
4. To provide views on the inter-state transmission system planned by CTU within 45 days of receipt of the proposal by NRPC. The views of NRPC will be considered by National Committee on Transmission for sending their recommendation to Ministry of Power for approval of new inter-state transmission system.
5. To coordinate planning & maintenance of generating machines of various generating companies of the region including those of inter-state generating companies supplying electricity to the Region on an annual basis and also to undertake review of maintenance programme on a monthly basis.
6. To undertake planning of outage of transmission system on a monthly basis.
7. To undertake operational planning studies including protection studies for stable operation of the grid.
8. To undertake planning for maintaining proper voltages through review of reactive compensation requirement through system study committee and monitoring of installed capacitors.
9. To evolve consensus on all issues relating to economy and efficiency in the operation of power system in the region.

10. Issuance of various Energy accounts mandated by various CERC regulations

- i. Monthly Energy Accounts:
  - a. Regional Energy Account (REA) including Ramping Capability of CGSs, Thermal Generators, Heat Rate Compensation for part load operation and Secondary Oil Compensation.
  - b. Regional Transmission Account (RTA)
  - c. Regional Transmission Deviation Account (RTDA)
  - d. SCED Account
  
- ii. Weekly Statement of Deviation Settlement Charges, Reactive Energy Charges and Ancillary Services Charges.
  
- iii. Quarterly statement of Interest Charges on Late Payment of above weekly accounts.

11. Allocation of Power from Central Generating Station of NR.

**SUMMARY OF PROPOSAL**

<b>For Official Use - To be filled by the Nodal Agency</b>	
Project Proposal Number : _____	Date of Receipt : _____

<b>To be filled by the Requesting Organization / Project Entity</b>	
1. Name of the requesting Organization / Utility :	Northern Regional Power Committee (NRPC)
2. Short Summary of Project / Scheme / Activity	
a. Name and location of the Project / Scheme / Activity :	Capacity Building programme on “International Best Practices in Energy Transition” for Constituents of Northern Regional Power Committee (NRPC)
b. Objective of the Project / Scheme / Activity :	<ol style="list-style-type: none"> <li>1. To understand the factors that contributed to the success of the power market liberalization in the Nordic region.</li> <li>2. To learn from international best practices in Hydro Power Development, Power Markets, energy transition – Hydrogen, decarbonization and offshore wind.</li> <li>3. Overview of Power Markets/Nord Pool at a Glance/ Intra day Trading demonstration.</li> <li>4. To understand Norwegian Hydrogen Economy and Low Carbon Society.</li> <li>5. Capacity building programme to handle trading of short term surplus power on the Power exchange.</li> <li>6. Interaction with EV Association, Norway on The Norwegian EV Experience.</li> <li>7. Price discovery in Nord pool.</li> <li>8. Determination of transmission tariff and sharing of transmission charges and losses.</li> <li>9. Financial settlement of power trades, imbalances.</li> </ol>

	<p>10. Organization of forwards, futures and options market in power, their operation procedures, hedging etc.</p> <p>11. Retail supply market.</p> <p>12. Market clearing and settlement.</p> <p>13. Market surveillance.</p> <p>14. Imbalance settlement procedure.</p> <p>15. Roles and responsibilities of various stakeholders.</p> <p>16. Reporting and information sharing.</p> <p>17. Optimum power reserve estimation.</p> <p>18. Real time system operation and management.</p> <p>19. Efficient maintenance practices of transmission grids.</p> <p>20. Better Understanding of the regulatory and policy framework of the power market in European countries.</p> <p>21. EV integration in the grid along with hydrogen powered vehicle.</p> <p>22. Learning the best industry practices in Nordic power market.</p> <p>23. Enhancement of productivity and performance.</p>
<p>c. Authorized Person For this Project / Scheme / Activity</p>	<p>Name : Vijay Kumar Singh, Member Secretary, NRPC</p> <p>E-mail ID : <a href="mailto:ms-nrpc@nic.in">ms-nrpc@nic.in</a></p> <p>Land line No : 011-26511211</p> <p>Mobile No. : 9810177609</p> <p>Fax No : 011-26868528</p>
<p>d. Nature of the Project / Scheme / Activity: Inter – State / Intra – State (Please Specify)</p>	<p>Training and Capacity Building of constituents of Northern Region</p>
<p>e. Identified Beneficiaries</p>	<p>Personnel from the Central Transmission Utility (CTU), State Transmission Utilities (STUs), Distribution Companies (DISCOMs), State Load Despatch Centres (SLDCs), Generators (including ISGS), ISTS Transmission Licensees in Northern Region), Grid Controller of India Limited and Northern Regional Power</p>

	Committee (NRPC) Secretariat. Participation from Central Electricity Authority (CEA), Ministry of Power, GoI has also been envisaged.
f. Merits of the scheme	The programme will enable to understand: 1. Business Environment – Power Sector and Strategy framework 2. Energy Transition 3. Power Market Development 4. Energy transformation and decarbonisation Further detailed in <b>Annexure-A</b> .
g. Limitations, if any	No limitations
h. Time frame for Implementation	FY 2024-25 3 batches (each of 20 officials)
i. Estimated Cost of Project / Scheme / Activity	Rs. 7,61,73,720/--
j. Category under which the project is classified (Please refer Para 5.1 of the Guidelines/Procedure)	Para 5.1(e)

Date: \_\_\_\_\_

Signature: \_\_\_\_\_

Name: \_\_\_\_\_

(Authorized Representative)



## DETAILED PROPOSAL (DP)

### 1. Details of the Requesting Organization / Project Entity

#### 1.1 Details of Organization / Entity

Name of Organization / Entity	Northern Regional Power Committee
Acronym or Abbreviation (if applicable)	NRPC

#### 1.2 Details of Head of the Organization

Name (Mr / Ms / Mrs)	Mr. Vijay Kumar Singh
Designation	Member Secretary
E-mail Address	<a href="mailto:ms-nrpc@nic.in">ms-nrpc@nic.in</a>
Landline No.	011-26511211
Fax No.	011-26868528
Address	18-A, Shaheed Jeet Singh Marg, Katwaria Sarai,
City	New Delhi
Postal Code	110016

#### 1.3 Details of Project Incharge / Project Manager (Authorized Person) for this project/scheme/activity (Not below the rank of Dy. General Manager / Superintending Engineer)

Name (Mr / Ms / Mrs)	Mr. Vijay Kumar Singh
Designation	Member Secretary
E-mail Address	<a href="mailto:ms-nrpc@nic.in">ms-nrpc@nic.in</a>
Landline No.	011-26511211
Mobile No.	9810177609
Fax No.	011-26868528
Address	18-A, Shaheed Jeet Singh Marg, Katwaria Sarai,
City	New Delhi
Postal Code	110016

### 2. Justification of the Proposal

#### 2.1 Analysis of the Objective

- The Electricity Act 2003 opened the power sector by laying down provisions for promoting competition in the power market. By identifying electricity trade

as a distinct activity, Electricity Act 2003, along with pursuant regulations from the CERC, paved the way for a paradigm shift in the power sector.

- The Act envisages development of a competitive power market for promoting efficiency, economy and for mobilisation of new investments in the power sector. These transformations in power sector were supported by creation of institutions to enhance efficiency in markets via bilateral trading and later in 2008 through trading on power exchanges.
- In addition, the fundamentals of power trading – such as licensing electricity traders and ensuring open, non-discriminatory access to transmission services – have been put into place to allow for expansion of opportunities in all markets. As a result, there has been a paradigm shift in generation, transmission and distribution activities, which have facilitated power trading.
- Nord Pool Spot runs the largest market for electrical energy in Europe, measured in volume traded (TWh) and in market share.
- It operates in Norway, Denmark, Sweden, Finland, Estonia, Latvia, Lithuania, Germany and the UK. More than 80% of the total consumption of electrical energy in the Nordic market is traded through Nord Pool Spot.
- The capacity building programme will help personnel involved in Grid operation and transmission planning & implementation in understanding the policy and regulatory framework of Nordic power trading market.
- It will be immensely helpful as the participants will get to know about the successful working of Europe's leading power exchange, the integrated power markets and the financial derivative market.
- The program will include exposure to all the key issues related to a competitive power market, price determination, congestion management, imbalance management, reference price, risk management and market surveillance.
- European countries have high share of renewable energy in their power system. The effect of this RE power in power trading can be studied thoroughly by this capacity building program. As India is planning to add 175 GW of renewable energy by 2022 under its commitment towards global

climate change, the program will surely help in this direction. Also refer **Annexure-A**

## **2.2 Identified Beneficiaries of the Project**

Personnel from the Central Transmission Utility (CTU), State Transmission Utilities (STUs), Distribution Companies (DISCOMs), State Load Despatch Centres (SLDCs), Generators (including ISGS), ISTS Licensees in Northern Region, Grid Controller of India Limited and Northern Regional Power Committee (NRPC) Secretariat will benefit from the scheme. Participation from CEA/MoP has also been envisaged.

## **2.3 Identified Source of Funding**

The programme is to be funded fully from PSDF. As mentioned in the Para 6.3(III) of the guidelines/procedure for disbursement of PSDF approved by Government of India that up to 100 % grant to be given in case the project (Capacity Building) mentioned under Para 5.1(e) of the same.

## **2.4 Details of Activities for Project / Scheme / Activity**

- The programme will be implemented in three batches.
- Eight days (6 days training and 2 days travel) Training Program is proposed to be conducted for each batch.
- The programme will be held between 01.05.2024 and 30.10.2024.
- The training programmes will be held in Norway and Finland.
- 3 batches each of 20 participants will participate for each 8-day program from various utilities of Northern Region including CTU, SLDCs, STUs, Generators, ISTS Licensees, DISCOM, Grid-India, NRPC Sectt, CEA and Ministry of Power.
- Training Modules to cover various aspects of Power market operations, impact of renewables through imbalance handling in energy trading as well as cross border trading with neighbouring countries. The programme is

designed to meet the needs of top officials of electricity utilities of India to understand:

- a. Business Environment – Power Sector and Strategy framework
  - b. Energy Transition
  - c. Power Market Development
  - d. Energy transformation and decarbonisation
- Training Modules for such programs have been designed after consultation with POWERGRID.
- Field visits will be arranged during the programs to impart practical training to the participants.

## **2.5 Executing Agency**

POWERGRID will be the executing agency through Administrative Staff College of India (ASCI).

## **2.6 Time line for Implementation of Project / Scheme / Activity**

The programme is to be completed in FY 2024-25.

<b>Timeline of the Project / Scheme / Activity</b>	
<b>Duration of Project (in Months)</b>	Between 01.05.2024 and 30.10.2024 (06 months). 3 batches each of 20 participants.
<b>Likely Start Date</b>	01.05.2024
<b>Likely Completion Date</b>	30.10.2024

Date: \_\_\_\_\_

Signature: \_\_\_\_\_

Name: \_\_\_\_\_

(Authorized Representative)

Sl. No	Description	Feb'24	June'24	July'24	Aug'24	Oct'24
1	Programme Approval					
2	1 <sup>st</sup> Program (proposed)					
3	2 <sup>nd</sup> Program (proposed)					
4	3 <sup>rd</sup> Program (proposed)					
6	Programme Report					

Date: \_\_\_\_\_

Signature: \_\_\_\_\_

Name: \_\_\_\_\_

(Authorized Representative)

## **Summary of Detailed Project Report (DPR)**

**Objective:** Capacity building of the personnel involved in Grid Operation, transmission planning & implementation and overall policy & decision making towards creation of efficient power markets and participation in power trading.

**Executing Agency:** The programme is to be executed by POWERGRID and all arrangements like designing modules in consultation with ASCI, and power system experts of NR utilities and coordination with Nordic countries, signing of contract with Norwegian agencies, selecting travel partner, visa etc. shall be undertaken by Powergrid Corporation of India Limited.

**No of Programs and participants:** Total 3 nos. of programs are proposed to be conducted over one year. Each batch having 20 nos. of participants from NRPC constituents. Personnel from the Central Transmission Utility (CTU), State Transmission Utilities (STUs), Distribution Companies (DISCOMs), State Load Despatch Centres (SLDCs), Generators (including ISGS), ISTS Licensees in Northern Region, Grid Controller of India Limited and Northern Regional Power Committee (NRPC) Secretariat will benefit from the scheme. Participation from CEA/MoP has also been envisaged.

**Venue of Programme:** The capacity building programme will be held at Norway and Finland starting from POWERGRID, Manesar.

### **Duration of Programme:**

Participants per batch	Duration of each Program (in days) each year	Total years for which program will run
20	8 days (6 + 2 days for travel)	1 year

**Course Content/ Training Modules:** The tentative topics to be covered are placed below.

1. To understand the factors that contributed to the success of the power market liberalization in the Nordic region.
2. Capacity building programme to handle trading of short term surplus power on the Power exchange
3. Price discovery in Nord pool.
4. Determination of transmission tariff and sharing of transmission charges and losses.
5. Financial settlement of power trades, imbalances.
6. Organization of forwards, futures and options market in power, their operation procedures, hedging etc.
7. Retail supply market
8. Market clearing and settlement
9. Market surveillance
10. Imbalance settlement procedure
11. Roles and responsibilities of various stakeholders
12. Reporting and information sharing
13. Optimum power reserve estimation
14. Real time system operation and management
15. Efficient maintenance practices of transmission grids
16. Better Understanding of the regulatory and policy framework of the power market in European countries.
17. EV integration in the grid along with hydrogen powered vehicle.
18. Learning the best industry practices in Nordic power market.
19. Enhancement of productivity and performance.

**Total Cost of Training (refer Format A4):**

<b>No of Programs of 8 days duration</b>	<b>Total (In Rs.)</b>
3	7,61,73,720/- (including GST)

- Cost is inclusive of all taxes. However, tax rates are subject to revision by Government.
- Final payment will be made on the basis of actuals

**Terms of payment:**

- (1) 80% of payment for first batch on signing of contract
- (2) 20% payment for first batch ten days before departure of group from India
- (3) For subsequent batches, 80% payment on finalization of dates and balance 20% ten days before departure of group from India

**Summary of DPR given - Yes.**

**Copy of the Proposal attached. – Yes**

Date: \_\_\_\_\_

Signature: \_\_\_\_\_

Name: \_\_\_\_\_

(Authorized Representative)



## Financial Implication of the Scheme

*(Guidelines: The financial implications of the proposal may be worked out as accurately as possible and should be detailed in this section. Further, the manner in which the expenditure is proposed to be borne may also be clearly indicated. Please provide the project cost estimate for its scheduled duration along with a break-up of year-wise, component-wise expenses segregated into non-recurring and recurring expenses.)*

### 1. Summary

S.No.	Item	Amount in Rs.
1.	Total Cost Estimate	7,61,73,720/-
2.	Funding Proposed from PSDF	7,61,73,720/-
3.	Contribution from Internal Sources	Nil
4.	External Borrowings	Nil

### 2. Details (Proposal POWERGRID is **at Annexure-C**)

#### 2.1 Cost Estimate

1. Estimated cost for three batches (consisting 20 persons each): Rs. 7,61,73,720/-

*(Includes tuition fees for domestic & Overseas, training kit including trolley bags & Blazer, Boarding & Lodging and other land arrangements including airport transfers at overseas, Visa charges, Tickets (if any) to official engagements (entry tickets to sight-seeing, conferences etc. and membership to ASCI alumni network. Air fare economy class (Delhi to Oslo, Helsinki to Delhi), Medical cum travel insurance, Airport transfer in India, Boarding & Lodging at PAL, Conferencing charges at PAL, POWERGRID Manpower engagement cost, and Overheads, Miscellaneous and Contingency etc. Incidental charge (\$50 per person for 6days) @1USD~INR83.24)*

2. Estimated cost per batch (consisting 20 persons each): Rs. 2,53,91,240/-

### 3. Funding

#### 3.1 Funding Proposed from PSDF as grant

The programme is to be funded completely from PSDF. As mentioned in the Para 6.3(III) of the guidelines/procedure for disbursement of PSDF approved by Government of India

that up to 100 % grant to be given in case the project (Capacity Building) mentioned under Para 5.1(e) of the same.

**3.2 Contribution from Internal Sources: Nil**

**3.3 External Borrowings: Nil**

Date: \_\_\_\_\_

Signature: \_\_\_\_\_

Name: \_\_\_\_\_

(Authorized Representative)

**Brief Details of the Project Appraisal by CTU / STU / RPC**

The applicant utility shall submit project appraisal by CTU / STU / RPC in the given format and a copy of the Appraisal Report should be attached at Annexure.

Item	Details to be filled by Applicant Utility	
Appraisal By:	CTU <input type="checkbox"/>	ST <input type="checkbox"/> <input checked="" type="checkbox"/>
Date of Submission to CTU / STU / RPC for approval	-----	
Name of the Scheme	Capacity Building programme on “International Best Practices in Energy Transition” for Constituents of Northern Regional Power Committee (NRPC).	
Details of the Appraisal Report by CTU/STU / RPC (Attached at Annexure)	Attached at <b>Annexure-B</b>	
Summary of observations from CTU/ STU/RPC Appraisal Report	Summary of Proposal Appraised	NRPC appreciated the initiative taken by NRPC Secretariat for benefit of NR constituents and <b>approved</b> the scheme for funding through PSDF.
	Technical Observations	
	Financial Observations	
	Compliance of Grid Standards / Codes by the Applicant	
	Limitations / Shortcomings pointed out by CTU/STU/RPC if any	
Recommendations of CTU/STU/RPC		

Date: \_\_\_\_\_

Signature: \_\_\_\_\_

Name: \_\_\_\_\_

(Authorized Representative)

I, Shri VIJAY KUMAR SINGH son of -----  
----- and presently working as Member Secretary, Northern  
Regional Power Committee hereby undertake to comply with the following terms  
and conditions with regard to funding of the “Capacity Building programme on  
“International Best Practices in Energy Transition” for Constituents of Northern  
Regional Power Committee (NRPC)” with disbursement from PSDF:

- **No tariff shall be claimed for the portion of the scheme funded from PSDF.**
- **Amount of grant shall be refunded in case of transfer/disposal of the facility being created under this proposal to any other scheme for funding.**
- **Shall specifically mention if for the scheme under the proposal, the grant from any other agency is being taken / proposed to be taken.**
- **The grant shall be refunded back to PSDF in case of non-utilisation of the grant within one year of release of instalment.**

Date: .

Signature: \_\_\_\_\_

Name: Vijay Kumar Singh  
(Authorized Representative)

## Supplementary Information

1. In 45th NRPC meeting held on 08.06.2019, NRPC proposed a capacity building programme for studying the power exchange of Nordic countries, role of TSO (Transmission System Operator), Renewable Energy in power trading, EV integration with grid etc. to be carried out for Northern Region Constituents.
2. POWERGRID vide letter dated 09.10.2019 was requested to furnish the complete proposal including estimated cost details for preparing the DPR for PSDF funding.
3. In 44th TCC & 47th NRPC Meetings (held on 10th and 11th December, 2019), POWERGRID presented the detailed report and commercial implication of the program.
4. Due to COVID pandemic, the program could not be completed.
5. Therefore, a revised estimate has been taken from POWERGRID and proposal of Capacity Building programme on “International Best Practices in Energy Transition” for Constituents of Northern Regional Power Committee (NRPC) has been approved in .....
6. The justification for selection of Nord Pool is given in DPR. Further, a detailed analysis is given in **Annexure-A**.
7. POWERGRID has been selected as implementing agency by NRPC Forum.
8. Total 3 nos. of programs are proposed to be conducted over one year. Each batch having 20 nos. of participants from NRPC constituents. Personnel from the Central Transmission Utility (CTU), State Transmission Utilities (STUs), Distribution Companies (DISCOMs), State Load Despatch Centres (SLDCs), Generators (including ISGS), ISTS Licensees in Northern Region, Grid Controller of India Limited and Northern Regional Power Committee (NRPC) Secretariat will benefit from the scheme. Participation from CEA/MoP has also been envisaged.
9. Criteria for Selection:
  - i. The officers nominated must have at least 3 years of service left.
  - ii. No of Candidates from Each state/utility shall be as per decision of NRPC forum so that 3 batches of 20 members each can be formed.

10.A copy of the minutes approved by Chairperson is enclosed for reference (refer **Annexure-B)**

## **Annexure-A**

### **Justification for NORD Pool**

**Introduction:** Power is a vital element that supports our modern lives at home and at work. As power production and transmission capacity has been extended over the years, transmission of power between countries has become more common. As a result, a dynamic market has evolved where power can be bought or sold across areas and countries more easily.

The power price is determined by the balance between supply and demand. Factors such as the weather or power plants not producing to their full capacity can impact power prices.

While the price of power is determined according to supply and demand, it also becomes clear where there are issues in the grid when the price of power goes up. This makes it easier to identify where production or capacity is lacking, as there is too high demand compared to production supply.

**The Indian Context:** The Indian power market consists of OTC Bilateral trades and non-mandatory power exchange structure. With increasing participation from the private players the trading on the exchange is bound to increase in the future. Further, to meet the requirements of customers, power exchanges have to bring out newer products such as derivatives. Also, more and more players are becoming eager to purchase power in short term on the exchanges. The integration of renewables will also give a push towards innovative products for handling of this power. The market, regulatory environment and the operator have to jointly discuss and prepare the ground for a vibrant power market in India. A competitive power market will reduce prices and increase welfare.

Although, India has deregulated generation, the power market does not have sufficient depth as most of the power sales are dictated according to long term contracts. Day by day the commercial settlements and system operation are getting complex as decisions of the operator in a regulated environment affect the financial obligations of the players. The road ahead lies in reducing regulatory rule making and letting the market take over some of the pricing signals.

It is seen from recent experience that beneficiaries of many of the generators who have long term contracts under two-part tariff are reluctant to purchase power under the long

term PPA and try to economize their portfolio through buying and selling power on the OTC markets and also on the exchange. Therefore, constituents feel a need to participate in power markets.

The national tariff policy 2005 stated thus:

*5.2 The real benefits of competition would be available only with the emergence of appropriate market conditions.*

9.0 The Act provides that the Appropriate Commission ..... necessary. Though *there is a need to promote trading in electricity* for making the markets competitive, the Appropriate Commission should monitor the trading transactions continuously and ensure that the electricity traders do not indulge in profiteering in situation .....

However, the directions of the tariff policy could not have been implemented fully. The CERC report on Short Term Power Market in India: 2015-16 has the following to offer:

1. Of the total electricity procured in India in 2015-16, the short-term power market comprised 10%. The balance 90% of generation was procured mainly by distribution companies through long-term contracts and short-term intra-state transactions.

*Therefore, the participation in short term power market is still in nascent stages*

2. In terms of volume, the size of the short-term market in India was 115.23BU (Billion Units) in the year 2015-16. As compared to the volume of electricity transacted through short-term market in the year 2014-15 (98.99BU), this was about 16% higher.

*There is a desire for increased participation in the short term power markets.*

7. During 2015-16, about 93% of the volume of electricity transacted through traders was at a price less than Rs. 6/kWh. About 61% of the volume was transacted at a price less than Rs. 4/kWh.
8. During 2015-16, IEX transacted 99% of the volume of electricity at a price less than Rs. 6/kWh while about 92% of the volume was transacted at a price less than Rs 4/kWh. During the year, PXIL transacted 99% of the volume of electricity at a price less than Rs. 6/kWh while about 76% of the volume was transacted at less than Rs. 4/kWh.

*Purchase of power in short term power markets is cost effective.*

11. Competition among the trading licensees was shown for the period from 2004-05 to 2015-16. During the period, number of traders who were undertaking trading

increased from 4 to 27 and concentration of market power (HHI based on volume of trade undertaken by the licensees) declined from high concentration (HHI of 0.5512) to non-concentration (HHI of 0.1432).

*The Indian Power market is competitive with non-concentration of market power.*

Government of India have also proceeded with the SAARC Framework Agreement for Energy Cooperation (Electricity) which will facilitate trading of electricity among member nations of SAARC. This will create challenges as well as opportunities for electricity trade as different regulatory regimes will come into picture. *The development of a cross border market for electricity is also not far.*

Recently, as per Tariff Policy, 2016, Central generating stations unable to get their power scheduled are bringing their power to market for sale.

*Although all the ingredients of a successful power market are present participants have to build confidence to come out of their comfort zone of long term PPA and buy and sell power on the market. In turn the market has to give that confidence to the participants.*

*It is natural that a commodity like electricity, non availability of which has huge negative welfare implications would make the buyers shaky in case the market fails to operate optimally. Therefore, a visit to Nord Pool which operates one of the oldest and one of the biggest power markets in Europe would help in building confidence.*

**International Context:** The last decade has seen the deregulation of several power markets around the world, and especially the US and EU electricity supply industries are undergoing a process of fundamental change. A central feature of most liberalised markets is a Power Exchange, PX, with an optional or mandatory spot market, and, as a complement, a market for financial instruments (futures, forwards and options)

The spot market accommodates suppliers and consumers in an auction determining market clearing prices and quantities, while the financial market performs price hedging. In Europe today, there are PXs with spot markets in England and Wales, The Netherlands, Scandinavia (Denmark, Finland, Norway and Sweden), Spain and Switzerland. The Scandinavian deregulation led to the establishment in 1993 of the joint Nordic Electricity Exchange, otherwise known as Nord Pool.

Scandinavia, where countries have traded power for decades, has the world's most developed international market for electric power. Recently the trading system has changed dramatically, moving from the old model of cooperation among the leading vertically integrated utilities in each country, under the Nordel agreement, to competitive market rules. The Nordic countries deregulated their power markets in the early 1990s and brought their individual markets together into a common Nordic market. Estonia, Latvia and Lithuania deregulated their power markets, and joined the Nord Pool market in 2010-2013.



To attract customers, a non-mandatory PX needs a spot market that creates confidence among its actual and potential participants. Effective competition in the spot market is important from several perspectives, directly for cost efficiency, transaction costs and the potentially large distributional effects of market power, indirectly for its impact on related financial markets.

*The Nord Pool has over the years established itself as a very efficient and transparent wholesale power market having the confidence of the market participants.*

*Nord Pool has played an important role in setting up of various other National/International Power Exchanges such as the Leipzig power exchange (LPX) in Germany, developing the power market in South African Power Pool (involving 12 countries), etc. Nord Pool is one of the regional power pool having mature regional electricity market and facilitate more than 80% of the total Nordic electricity consumption through Nord Pool spot market.*

In addition to the spot market, Nord Pool offers futures contracts, which are traded as weekly contracts four to seven weeks ahead, as blocks of four weeks up to fifty-two weeks ahead, or as seasons up to three years ahead. The futures are purely financial contracts used for price hedging. About fifteen brokering companies offer services to the electricity market. The bulk of the volume traded is in standardized financial contracts, often referred to as over-the-counter (OTC) contracts. The liquidity of the OTC market is quite high, particularly for the nearest season. Contracts can be resold, or a position netted out by making an opposite contract.

Just as for bilateral trade, the PX-based financial market is heavily dependent on a well functioning spot market to provide a relevant reference price. Any unnecessary uncertainty in the spot price, due to possible strategic pricing, lends an extra uncertainty to the financial contract prices. This leads to a diminished trade on the financial market which in turn decreases the possibility for all participants in the electricity market to hedge their contracts, thus reducing liquidity in the whole market. Research also indicates that the presence of a well functioning financial (futures) market might actually reduce market power on the spot market.

*Nord Pool has well established and transparent futures products in electricity. By providing tools for risk management, the financial market contributes to the efficient functioning of both wholesale and end-user markets. The listed derivatives at Nord Pool are traded with a reference price based on the system price in the Nordic day-ahead spot market. The financial market is as such a purely financial market where all contracts are traded and settled irrespective of transmission capacity.*

The Nordic financial electricity market Report 8/2010 of NordREG (NordREG is a cooperation of the Nordic energy regulators) states:

*NordREG has found that the general view is that the Nordic financial electricity market functions well and has a good liquidity in the basic products. There is also a general consensus that there is trust in the market. The Nordic power market is often ranked highest in Europe regarding transparency and efficiency. The Nordic power market also has the highest turnover in exchange trading in relation to consumption in the area.*

## **A Chronology of the development of Nord Pool over the years.**

**2016:** Nord Pool Spot is rebranded to Nord Pool.

Nord Pool is appointed NEMO in Belgium, Germany, Luxembourg and Poland. Nord Pool is together with IBEX opening the Bulgarian power market and together with Croupex opening the Croatian power market.

**2015:** Nord Pool Spot introduce a new Day Ahead Web and Intraday Web. Nord Pool Spot is appointed Nominated Electricity Market Operator (NEMO) across 10 European power markets; Austria, Denmark, Estonia, Finland, France, GB, Latvia, Lithuania, the Netherlands and Sweden.

**2014:** Nord Pool Spot takes sole ownership of the UK market. North-Western European power markets are coupled through the Price Coupling of Regions (PCR) project. Nord Pool Consulting is launched.

**2013:** Elspot bidding area opened in Latvia. Intraday market, Elbas, introduced in both Latvia and Lithuania.

**2012:** Nord Pool Spot opens bidding area in Lithuania.

**2011:** Elbas licensed to APX and Belpex as the intraday market in the Netherlands and Belgium respectively.

**2010:** Nord Pool Spot and NASDAQ OMX Commodities launch the UK market N2EX. Nord Pool Spot opens a bidding area in Estonia and delivers the technical solution for a new Lithuanian market place.

**2009:** Norway joins the Elbas intraday market. The European Market Coupling Company relaunches the Danish-German market coupling on 9 November. Nord Pool Spot implements a negative price floor in Elspot.

**2008:** Highest turnover and market share recorded in the company's history until then. Elspot market share 70%.

**2007:** Western Denmark joins the Elbas market. SESAM, the new Elspot trading system is set into production.

**2006:** Nord Pool Spot launches Elbas in Germany.

**2005:** Nord Pool Spot opens the Kontek bidding area in Germany, which geographically gives access to the Vattenfall Europe Transmission control area.

**2004:** Eastern Denmark joins the Elbas market.

**2002:** Nord Pool's spot market activities are organized in a separate company, Nord Pool Spot AS.

**2000:** The Nordic market becomes fully integrated as Denmark joins the exchange.

**1999:** Elbas is launched as a separate market for balance adjustment in Finland and Sweden. Elspot area trade begins 1 July.

**1998:** Finland joins Nord Pool ASA. Nord Pool opens an office in Odense, Denmark.

**1996**

A joint Norwegian-Swedish power exchange is established. The exchange is renamed Nord Pool ASA.

**1995:** The framework for an integrated Nordic power market contracts was made to the Norwegian Parliament. Together with Nord Pool's license for cross-border trading (given by the Norwegian Water Resources and Energy Administration), this report made the foundation for spot trading at Nord Pool.

**1993:** Statnett Marked AS is established as an independent company. Total volume in the first operating year is 18.4 TWh, at a value of NOK 1.55 billion.

**1991:** Norwegian parliament's decision to deregulate the market for trading of electrical energy goes into effect.

**Annexure-B**

Will be attached after approval.

**Annexure-C**

**Details of Cost Estimate Calculations**

<b>S/N</b>	<b>Scope of Work</b>		<b>Amt (INR)</b>
1	Activities under the scope of ASCI	Includes tuition fees for domestic & Overseas, training kit including trolley bags & Blazer, Boarding & Lodging and other land arrangements including airport transfers at overseas, Visa charges, Tickets (if any) to official engagements (entry tickets to sight-seeing, conferences etc. and membership to ASCI alumni network.	18891800
2	Activities under the scope of POWERGRID	Air fare economy class (Delhi to Oslo, Helsinki to Delhi), Medical cum travel insurance, Airport transfer in India, Boarding & Lodging at PAL, Conferencing charges at PAL, POWERGRID Manpower engagement cost, and Overheads, Miscellaneous and Contingency etc.	6000000
		**Incidental charge (\$50 per person for 6days)@1USD~INR83.24	499440
	Total including GST for one batch		<b>25391240</b>
	Total including GST for three batches		<b>76173720</b>

\*\*\*\*\*

 <p>भारतीय लेखा विभाग + INDIAN AUDIT AND ACCOUNTS DEPARTMENT लोकहितार्थं सत्यनिष्ठा Dedicated to Truth in Public Interest</p>	<p><b>भारतीय लेखा एवं लेखा-परीक्षा विभाग</b> कार्यालय महानिदेशक लेखा-परीक्षा (ऊर्जा), नई दिल्ली INDIAN AUDIT AND ACCOUNTS DEPARTMENT Office of the Director General of Audit (Energy), New Delhi</p>
<p>Half Margin No. 11 Date: 05.12.2023</p>	<p>Camp: NRPC, New Delhi</p>

**Sub: Defective policy and planning resulted in in-ordinate Delays in receipt of annual contribution amounting to Rs. 52.00 lakh apart from penalty thereof amounting to Rs. 9.40 lakh from the constituent members.**

In pursuance to Government of India, Ministry of Power resolution dated 25th May 2005 Regional Power Committee had been constituted in place of Regional Electricity Boards. NRPC started its functions w.e.f 1st April 2006. Ministry of Power directed the activities of RPCs will be fully financed by constituent members with effect from 1.04.2006 and that each member may contribute Rs 8 lakh for the financial year 2006-07 towards the annual expenditure of NRPCs. Thereafter, every constitute member has to pay annual contribution as decided in NRPC meeting the expenditure of NRPC Secretariat from time to time.

Audit of the related records and the information supplied by NRPC revealed that in 49<sup>th</sup> MCM, NRPC decided that it would issue demand letter by 01.10.21 and interest for FY 2021-22 would be levied from 15.11.2021 onwards i.e. beyond 15.11.21, 1% interest up to 30.11.21 for November month, and so on. Payment made during month would also invite 1% interest. Also, NRPC in 63<sup>rd</sup> MCM NRPC decided that it would issue demand letters by 28.02.2023 and interest for current FY 2022-23 would be applicable from 01.04.2023 onwards i.e. beyond 31.03.2023, 1% interest upto 30.04.2023 for April month, and so on. Payment made during any date of months after March 2023 would invite 1% interest per month starting from April 2023.

In this regard, it is observed that the following constituent members have been defaulters in paying the contribution to the NRPC Fund and a contribution of Rs. 52.00 lakh plus the penalty applicable for Rs. 2.00 lakh for the period 2014-15 to 2022-23 which remained pending as on 31.08.2023:

Sl. No.	Member	Year	Outstanding Amount	Penalty @1%	Total Outstanding
1	J & K State Power Development Corp. Ltd.	2014-15	1100000	-	1100000
		2015-16	1100000	-	1100000
		2018-19	1000000	-	1000000
2	J&K State Power Development Department	2019-20	1000000	-	1000000
		2021-22	1000000	200000	1200000
		2022-23			
<b>Grand Total</b>			<b>52,00,000</b>	<b>2,00,000</b>	<b>54,00,000</b>

Further, Audit found that NRPC failed to raise timely demands and therefore resulted in delays in recover the contributions from the members. During FY 2021-22, demand was raised on 01.10.21; and that of financial year 2022-23 on 28.02.2023; i.e. after a gap of 6 months and 11 month of the financial years respectively. Hence, the penalty amounting to Rs.5.10 lakh (21members @Rs. 10.00 Lakh) and Rs. 2.30 lakh (14 members @ Rs.10.00 lakh) also remained unrecovered from the members (**Annex-1**) apart from consequential loss of recurring interest on timely deposit in the NRPC Fund kept in Nationalized Bank.

Thus, deficient planning has resulted in delayed contributions along with non-levying of penalty amounting to Rs. 61.40 lakh. NRPC may formulate the effective policy in recovering the contributions from its members and the penal interest and appropriate action thereof under intimation to audit.

NRPC is requested to furnish the reply within 3 days after receipt of Half Margin.

  
(Rajinder Raina)  
Sr. Audit Officer (LAP)

  
**To**  
**Member Secretary**  
**NRPC, Shaheed Jeet Singh Marg,**  
**Qutab Institutional Area, New Delhi**

## Annex-1

## Late/Delay Contribution for the period 2021-22

Sl. No.	Name	Date of receipt	Amount	Penalty@ 1%
1.	UPRVUNL	17.11.2021	100000	10000
2.	Jsw hydro	17.11.2021	100000	10000
3.	CTU	23.11.2021	100000	10000
4.	THDC	25.11.2021	100000	10000
5.	HVPNL	29.11.2021	100000	10000
6.	RVUNL	08.12.2021	100000	20000
7.	PITCUL	14.12.2021	100000	20000
8.	PGCIL	28.12.2021	100000	20000
9.	UPCL	28.12.2021	100000	20000
10.	IPGCL	29.12.2021	100000	20000
11.	HPSEB	21.12.2021	100000	20000
12.	DTL	10.01.2022	100000	30000
13.	DDL Tata Power	24.01.2022	100000	30000
14.	JVVNL	25.01.2022	100000	30000
15.	Dakshin Haryana Bijli	31.01.2022	100000	30000
16.	PSPCL	31.01.2022	100000	30000
17.	Greenka Group	31.01.2022	100000	30000
18.	HPPTCL	01.02.2022	100000	40000
19.	J&K PDCL	02.02.2022	100000	40000
20.	HPGCL	03.02.2022	100000	40000
21.	MVVNL	05.02.2022	100000	40000
<b>Total Penalty</b>			<b>2,10,00,000.00</b>	<b>5,10,000.00</b>

## Late/Delay Contribution for the period 2022-23

Sl. No.	Name	Date of receipt	Amount	Penalty@1%
1.	HPPTCL Shimla	04.04.2023	100000	10000
2.	UT Chandigarh	10.04.2023	100000	10000
3.	DTL	10.04.2023	100000	10000
4.	HPGCL	13.04.2023	100000	10000
5.	Adani Power System	13.04.2023	100000	10000
6.	Aravali Power comp.	20.04.2023	100000	10000
7.	NPCIL	26.04.2023	100000	10000
8.	NHPC	26.04.2023	100000	10000
9.	UPPTCL	27.04.2023	100000	10000
10.	Mahindra Susten pvt. Ltd.	20.05.2023	100000	20000
11.	JKPDC	13.05.2023	100000	20000
12.	HPSEB	30.05.2023	100000	20000
13.	AVVNL	20.06.2023	100000	30000
14.	DVVNL	08.08.2023	100000	50000
<b>Total Penalty</b>			<b>1,40,00,000.00</b>	<b>2,30,000.00</b>



सत्यमेव जयते

विजय कुमार सिंह  
सदस्य सचिव

भारत सरकार  
Government of India  
विद्युत मंत्रालय  
Ministry of Power  
उत्तर क्षेत्रीय समिति  
Northern Regional Power Committee

अर्ध शासकीय पत्र सं. NRPC/SER/310/2022-23/6744  
D.O. No.

दिनांक 19 सितम्बर, 2023  
Date : .....

Dear Shri Prasad Ji,

As you are aware that Northern Regional Power Committee (NRPC) was constituted vide Government of India's Resolution dated 25.05.2005 and subsequent Amendments dated 29.11.2005 and 9.05.2008. Further, as per Government of India, Ministry of Power's letter dated 23.02.2006; the activities of RPCs are to be fully financed by the constituent members (copy enclosed). For this purpose, NRPC constituent members are to pay annual contribution as decided in NRPC meetings from time to time.

In this regard, I want to invite your attention to my D.O. letter No.NRPC/SER/310/2022-23/6124 dated 21<sup>st</sup> July 2023 (Copy enclosed), wherein I conveyed the delay in payments of contribution amount by J&K (JKPDD and JKPDCI). Once again, details of pending payments are mentioned below:

S. No.	Name of Constituent	Period (FY)	Outstanding amount (Rs.)	Penalty (Rs.)	Total outstanding amount (Rs.)
1	J&K State Power Development Corp. Ltd.	2014-15	11,00,000	-	11,00,000
2		2015-16	11,00,000	-	11,00,000
3		2018-19	10,00,000	-	10,00,000
4	J&K State Power Development Department	2019-20	10,00,000	-	10,00,000
5		2021-22	10,00,000	1,80,000	11,80,000
<b>Grand Total</b>					<b>53,80,000</b>



This matter was further raised in 68<sup>th</sup> NRPC Meeting held on 18.08.2023, in which J&K representative stated that as per their records, all the pending amount has already been paid except for contribution fee for year 2021-22. The J&K was requested to send all the receipts of transactions to NRPC Secretariat so that payments received from J&K can be checked again for reconciliation of the matter. However, no communication has been received in this matter till date.

NRPC Secretariat has re-checked in its records and has found no details of payments as mentioned by representative of J&K in 68<sup>th</sup> NRPC Meeting. Therefore, total amount of Rs.32,00,000/- and Rs.21,80,000/- is still pending with JKPDD and JKPDCCL respectively. If payment has already been done, J&K is again requested to send the details of payment.

I would like to mention that NRPC Secretariat has communicated with your offices many times (copy enclosed) and my predecessor Member Secretary, NRPC also written number of D.O. letters to your office in this regard (copy enclosed).

I request you to please intervene in the matter and give directions to both the departments for making payment of aforementioned contribution amount on priority for smooth functioning of NRPC Secretariat. The payment could be made through Demand Draft drawn in favour of "NRPC Fund" or through RTGS in the Bank account named "NRPC Fund" (A/c No.3083000105096078 RTGS / NEFT Code: PUNB0308300).

Yours sincerely,

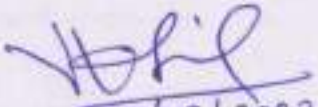
  
19/09/2023  
(Vijay Kumar Singh)

✓  
Shri H. Rajesh Prasad, IAS  
Principal Secretary,  
Power Development Department, J&K,  
Civil Secretariat, Jammu -180001

Copy to:

1. Chief Engineer (OM), Ministry of Power, New Delhi
2. Managing Director, JKPDCCL, SLDC Building, 1<sup>st</sup> Floor, Gladni Grid Station, Narvel Bala, Jammu-180004



भारत सरकार

Government of India

विद्युत मंत्रालय

Ministry of Power

उत्तर क्षेत्रीय विद्युत समिति

Northern Regional Power Committee

संख्या: NRPC/SER/ 301 /2022/ 2032-2034

Dated: 23.02.2022

To,

Joint Secretary (OM),  
Ministry of Power,  
Room No-408,  
4th Floor, Shram Shakti Bhawan,  
Rafi Marg, New Delhi

**विषय:** Regarding long outstanding overdues of J&K State Power Development Corporation Ltd (JK PDCL) and Power Development Department (JKPDD)

**References:** NRPC letters to Secretary (Power) PDD, dated 07.02.2022, 29.12.2021, 26.07.2021, 11.09.2020, 28.01.2020, 31.10.2019 & 16.09.2019. NRPC letters addressed to MD, J&K State Power Development Corporation Ltd., dated 28.01.2020, 31.10.2019, 08.03.2019, 25.10.2018, 16.10.2018, 30.08.2017, 20.10.2015, 28.04.2015, 10.03.2015 & 30.12.2014.

Sir,

In accordance to the MoP communication to CEA vide letter no. A-60016/59/2005 Adm-I dated 23<sup>rd</sup> February 2006 (copy enclosed) which stipulates that

*"The activities of the Regional Power Committees (RPCs) will be fully financed by the constituent Members with effect from 01.04.2006 and Central Electricity Authority will take immediate steps in this regard."*

NRPC constituent members are to pay annual contribution as decided in NRPC meetings from time to-time, for reimbursing NRPC expenditure to GoI and meeting the expenditure for meetings at Secretariat and other expenditure as approved by Chairperson.

However, contribution from some members i.e J&K State Power Development Corporation Ltd (JK PDCL) and Power Development Department (JKPDD) is pending from a long time. NRPC is constantly following up with the officials of JKPDD & JKPDCL through above referred letters. Details of pending outstanding contribution fees is shown below:

Sl. No.	Name of the constituent	Period (FY)	Outstanding amount (RS)	Late payment penalty amount (Rs)	Total outstanding amount (Rs)
1	JKPCL / JKPDD	2021-22	10,00,000/-	10,000/-	10,10,000/-
		2019-20	10,00,000/-	-	10,00,000/-
Total outstanding amount					20,10,000/-

2.	JKPCL / JKPDC	2018-19	10,00,000/-	-	10,00,000/-
		2015-16	11,00,000/-	-	11,00,000/-
		2014-15	11,00,000/-	-	11,00,000/-
Total outstanding amount					32,00,000/-

**Grand total**

**52,10,000/-**

This is for you kind information and kind assistance in the subject matter.

न. भंडारी  
(नरेश भंडारी) 23/02/22  
सदस्य सचिव

**Encl: As above**

**Copy to:**

1. Managing Director, JKPCL, SLDC Building, 1<sup>st</sup> Floor Gladni Grid Station, Narval Bala, Jammu-180004

2. Chief Engineer, JKPCL, SLDC Building, 1<sup>st</sup> Floor Gladni Grid Station, Narval Bala, Jammu-180004

Date: February 23, 2006

To  
The Chairperson  
Central Electricity Authority,  
Sewa Bhawan, R.K.Puram,  
New Delhi.

(Attention: Shri Ajit Singh, Under Secretary)

**Subject:** Establishment of Regional Power Committees under the provisions of the Electricity Act, 2003 - matter regarding.

Sir,  
I am directed to refer to your letter No. 1/2/2005-PP (CEA), dated 13.07.2005 on the subject mentioned above and to say that consequent on setting up of Regional Power Committees (RPCs) under the aegis of the Electricity Act, 2003 in place of the erstwhile Regional Electricity Boards, the matter relating to administrative and financial set up of the RPCs has been considered by the Ministry in consultation with the Central Electricity Authority and the Internal Finance Wing of the Ministry.

2. The President is pleased to declare the Member Secretaries of the Regional Power Committees (RPCs) as 'Head of Department' under SR 2(10) of the Fundamental & Supplementary Rules. They shall exercise all the powers of Heads of Department under General Financial Rules, 1963, subject to the observance of instructions and restrictions contained in the Delegation of Financial Power Rules, 1978 and such other Rules and Orders issued by the Central Government from time to time applicable to 'Head of Departments'.

3. Further, with the approval of the Competent Authority in the Ministry of Power, it has been decided that, henceforth, the functioning of the RPCs shall be regulated as per the following arrangement

- (a) Member Secretaries of the Regional Power Committees (RPCs) will be under the administrative and financial control of the Chairman of the respective Regional Power Committee (RPCs) for all matters including sanction of leave, tour etc. of the Member Secretary.

(b) The Annual confidential Report of the Member Secretaries of the Regional Power Committees (RPCs) shall be initiated by the respective Chairman of the Regional Power Committee (RPCs) and shall be reviewed by the Chairperson, Central Electricity Authority.

(c) The activities of the Regional Power Committees (RPCs) will be fully financed by the constituent Members with effect from 01.04.2006 and the Central Electricity Authority will take immediate steps in this regard.

(d) The manpower for the Secretariat of the Regional Power Committees (RPCs) shall continue to be provided by the Central Electricity Authority.

4. This issues with the concurrence of the Internal Finance Wing vide their diary No. 7657/JSFA06, dated 16.02.2006.

Yours faithfully,

Sd/-

(R.C.Arora)

Under Secretary to the Government of India

Tel No. 2371-9637

Copy to:

1. Member Secretary of All Regional Power Committees
2. Controller of Accounts, Ministry of Power.
3. Secretary, CE.A/IS(Vig), CEA
4. Director (R & R) / US(Trans), Ministry of Power.
5. Finance/Budget V & S Desk, Ministry of Power.

Sd/-

(R.C.Arora)

Under Secretary to the Government of India

Tel No. 2371-9637



सत्यमेव जयते

भारत सरकार

Government of India

विद्युत मंत्रालय

Ministry of Power

उत्तर क्षेत्रीय विद्युत समिति

Northern Regional Power Committee

संख्या: NRPC/SER/ 301 /2022/

Dated: 15.03.2022

To,

The Principal Secretary,  
Power Development Department,  
J&K, Civil Secretariat, Jammu- 180001

**विषय:** Regarding long outstanding overdues of J&K State Power Development Corporation Ltd (JK PDCL) and Power Development Department (JKPDD)

**References:** NRPC letters to Secretary (Power) PDD, dated 07.02.2022, 29.12.2021, 26.07.2021, 11.09.2020, 28.01.2020, 31.10.2019 & 16.09.2019. NRPC letters addressed to MD, J&K State Power Development Corporation Ltd., dated 28.01.2020, 31.10.2019, 08.03.2019, 25.10.2018, 16.10.2018, 30.08.2017, 20.10.2015, 28.04.2015, 10.03.2015 & 30.12.2014.

Sir,

In accordance to the MoP communication to CEA vide letter no. A-60016/59/2005 Adm-I dated 23<sup>rd</sup> February 2006 (copy enclosed) which stipulates that

*"The activities of the Regional Power Committees (RPCs) will be fully financed by the constituent Members with effect from 01.04.2006 and Central Electricity Authority will take immediate steps in this regard."*

NRPC constituent members are to pay annual contribution as decided in NRPC meetings from time to-time, for reimbursing NRPC expenditure to GoI and meeting the expenditure for meetings at Secretariat and other expenditure as approved by Chairperson.

However, contribution from some members i.e J&K State Power Development Corporation Ltd (JK PDCL) and Power Development Department (JKPDD) is pending from a long time. NRPC is constantly following up with the officials of JKPDD & JKPDC through above referred letters. Details of pending outstanding contribution fees is shown below:

Sl. No.	Name of the constituent	Period (FY)	Outstanding amount (RS)	Late payment penalty amount (Rs)	Total outstanding amount (Rs)
1	JKPCL / JKPDD	2021-22	10,00,000/-	10,000/-	10,10,000/-
		2019-20	10,00,000/-	-	10,00,000/-
Total outstanding amount					20,10,000/-
2.	JKPCL / JKPDC	2018-19	10,00,000/-	-	10,00,000/-
		2015-16	11,00,000/-	-	11,00,000/-
		2014-15	11,00,000/-	-	11,00,000/-
Total outstanding amount					32,00,000/-
<b>Grand total</b>					<b>52,10,000/-</b>

In view of the above, you are requested to kindly intervene in the subject matter and advise the concerned officials of JKPCL to settle the long outstanding contribution amount.

न. शंडारी  
(नरेश भंडारी) 15/3/22  
सदस्य सचिव

Encl: As above

Copy to:

1. Joint Secretary (OM), MOP, New Delhi
2. Managing Director, JKPCL, SLDC Building, 1<sup>st</sup> Floor Gladni Grid Station, Narval Bala, Jammu-180004
3. Chief Engineer, JKPCL, SLDC Building, 1<sup>st</sup> Floor Gladni Grid Station, Narval Bala, Jammu-180004

Date: February 23, 2006

To  
The Chairperson  
Central Electricity Authority,  
Sewa Bhawan, R.K. Param,  
New Delhi.

(Attention: Shri Ajit Singh, Under Secretary)

**Subject: Establishment of Regional Power Committees under the provisions of the Electricity Act, 2003 - matter regarding.**

Sir,

I am directed to refer to your letter No. 1/2/2005-PP (CEA), dated 13.07.2005 on the subject mentioned above and to say that consequent on setting up of Regional Power Committees (RPCs) under the aegis of the Electricity Act, 2003 in place of the erstwhile Regional Electricity Boards, the matter relating to administrative and financial set up of the RPCs has been considered by the Ministry in consultation with the Central Electricity Authority and the Internal Finance Wing of the Ministry.

2. The President is pleased to declare the Member Secretaries of the Regional Power Committees (RPCs) as 'Head of Department' under SR 2(10) of the Fundamental & Supplementary Rules. They shall exercise all the powers of Heads of Department under General Financial Rules, 1963, subject to the observance of instructions and restrictions contained in the Delegation of Financial Power Rules, 1978 and such other Rules and Orders issued by the Central Government from time to time applicable to 'Head of Departments'.
3. Further, with the approval of the Competent Authority in the Ministry of Power, it has been decided that, henceforth, the functioning of the RPCs shall be regulated as per the following arrangement
  - (a) Member Secretaries of the Regional Power Committees (RPCs) will be under the administrative and financial control of the Chairman of the respective Regional Power Committee (RPCs) for all matters including sanction of leave, tour etc. of the Member Secretary.



- (b) The Annual confidential Report of the Member Secretaries of the Regional Power Committees (RPCs) shall be initiated by the respective Chairman of the Regional Power Committee (RPCs) and shall be reviewed by the Chairperson, Central Electricity Authority.
- (c) The activities of the Regional Power Committees (RPCs) will be fully financed by the constituent Members with effect from 01.04.2006 and the Central Electricity Authority will take immediate steps in this regard.
- (d) The manpower for the Secretariat of the Regional Power Committees (RPCs) shall continue to be provided by the Central Electricity Authority.

4. This issues with the concurrence of the Internal Finance Wing vide their diary No. 7657/JSFA06, dated 16.02.2006.

Yours faithfully,

Sd/-

(R.C.Arora)

**Under Secretary to the Government of India**

**Tel No. 2371-9637**

Copy to:

1. Member Secretary of All Regional Power Committees
2. Controller of Accounts, Ministry of Power.
3. Secretary, CEA/US(Vig),CEA
4. Director (R & R)/ US(Trans),Ministry of Power.
5. Finance/Budget/ V & S Desk, Ministry of Power.

Sd/-

(R.C.Arora)

**Under Secretary to the Government of India**

**Tel No. 2371-9637**



भारत सरकार  
Government of India  
विद्युत मंत्रालय  
Ministry of Power  
उत्तर क्षेत्रीय विद्युत समिति  
Northern Regional Power Committee

No. NRPC /AS/NRPC Fund/2021-22/1419-20

Date:07.02.2022

To,

Secretary (Power),  
Power Development Department,  
Civil Secretariat Srinagar  
0194-2506053/2506198

**Subject: Pending Contribution towards NRPC fund for the years 2019-20 and 2021-22.**

- References: (i) Reminder-5 Letter no. NRPC/AS/NRPC Fund/2021-22/11926 dated 29.12.2021  
(ii) Reminder-4 Letter no. NRPC/AS/NRPC Fund/2021-22/6940 dated 26.07.2021  
(iii) Reminder-3 Letter no. NRPC/AS/NRPC Fund/2020-21/9010-9012 dated 11.09.2020  
(iv) Reminder-2 Letter no. NRPC/AS/NRPC Fund/2019-20/837 dated 28.01.2020  
(v) Reminder-1 Letter no. NRPC/AS/NRPC Fund/2019-20/13367 dated 31.10.2019  
(vi) Letter no. NRPC/AS/NRPC Fund/2019-20/10396 dated 16.09.2019

Sir,

This is in continuation to NRPC's earlier communications as referred above. Copies of the same are also enclosed for ready reference. Despite our regular follow ups, NRPC Fund contribution of Rs. 10 Lakh for the previous year (FY 2019-20) and Rs.10.2 Lakh for current F.Y. 2021-22 is still awaited from PDD.

It was intimated by the reminder letter No. 5, that in case of late payment beyond 31/12/2021, for the FY 2021-22, simple interest @ 1% per month shall also be levied, as per decision taken in 49<sup>th</sup> NRPC meeting. Accordingly, the penalty amount for late payment beyond 31/12/2021 works out Rs.20,000/- Therefore, due NRPC contribution for FY 2021-22 becomes Rs 10.20 lakh.

Power Development Department is requested to make payments of Rs. 10 Lakh for the previous year (FY 2019-20) and Rs.10.20 Lakh for current F.Y. 2021-22 before 28.02.2022 positively to avoid further levy of penalty charges (for FY 2021-22) as per the decision taken in 49<sup>th</sup> NRPC meeting.

In view of the above, it is again requested to expedite the process for clearance of aforesaid contribution amount. The contribution can be made through Demand Draft, drawn in favour of "NRPC Fund" and may be forwarded to us. The contribution can also be deposited in any CBS branch of Punjab National Bank or through RTGS in the account named "NRPC Fund" (A/c No. 308300 0105096078) under intimation to us. The RTGS / NEFT Code is PUNB0308300

Encl: As above

*Draft* 11/2/2022

(दिलप्रीत कौर)

(Dilpreet Kaur)

नोडल ऑफिसर-एन आर पी सी फण्ड

Nodal Officer-NRPC Fund

Copy to:

Chairman, NRPC

**REMINDER-5**

भारत सरकार  
Government of India  
विद्युत मंत्रालय  
Ministry of Power  
उत्तर क्षेत्रीय विद्युत समिति  
Northern Regional Power Committee

No. NRPC /AS/NRPC Fund/2021-22/11925

Date: 29.12.2021

To,

Sh. Rohit Kansal (IAS)  
Secretary Power,  
Power Development Department,  
Civil Secretariat Srinagar  
0194-2506053/2506198

Subject: Pending Contribution towards NRPC fund for the years 2019-20 and 2021-22  
- reg.

- References: (i) Reminder-4 Letter no. NRPC/AS/NRPC Fund/2021-22/6940 dated 26.07.2021  
(ii) Reminder-3 Letter no. NRPC/AS/NRPC Fund/2020-21/9010-9012 dated 11.09.2020  
(iii) Reminder-2 Letter no. NRPC/AS/NRPC Fund/2019-20/837 dated 28.01.2020  
(iv) Reminder-1 Letter no. NRPC/AS/NRPC Fund/2019-20/13367 dated 31.10.2019  
(v) Letter no. NRPC/AS/NRPC Fund/2019-20/10396 dated 16.09.2019

Sir,

This is in continuation to NRPC's earlier communications as referred above. Copies of the same are also enclosed for ready reference. Despite our regular follow ups, the contribution amount of Rs. 10 Lakh for the previous year (FY 2019-20) and Rs.10 Lakh for F.Y. 2021-22 from your organisation is still awaited.

In case of late payment beyond 31/12/2021, for the FY 2021-22, simple interest @ 1% per month shall also be levied, as per decision taken in 49<sup>th</sup> NRPC meeting. Accordingly, Power Development Department is requested to make payments before 31.12.2021 positively.

In view of the above, it is again requested to expedite the process for clearance of aforesaid contribution amount. The contribution can be made through Demand Draft, drawn in favour of "NRPC Fund" and may be forwarded to us. The contribution can also be deposited in any CBS branch of Punjab National Bank or through RTGS in the account named "NRPC Fund" (A/c No. 308300 0105096078) under intimation to us. The RTGS / NEFT Code is PUNB0308300

Encl: As above

*Dilpreet Kaur*  
(दिलप्रीत कौर)

(Dilpreet Kaur)

नोडल ऑफिसर-एन आर पी सी फण्ड

Nodal Officer-NRPC Fund



सत्यमेव जयते

भारत सरकार

Government of India

विद्युत मंत्रालय

Ministry of Power

उत्तर क्षेत्रीय विद्युत समिति

Northern Regional Power Committee

REMINDER-4

No. NRPC /AS/NRPC Fund/2021-22 / 6940

Date:26.07.2021

To,

Sh. Rohit Kansal (IAS)  
Secretary Power,  
Power Development Department,  
Civil Secretariat Srinagar  
0194-2506053/2506198

Subject: Pending Contribution towards NRPC fund for the years 2019-20 – reg.

- References: (i) Reminder-3 Letter no. NRPC/AS/NRPC Fund/2020-21/9010-9012 dated 11.09.2020  
(ii) Reminder-2 Letter no. NRPC/AS/NRPC Fund/2019-20/837 dated 28.01.2020  
(ii) Reminder-1 Letter no. NRPC/AS/NRPC Fund/2019-20/13367 dated 31.10.2019  
(iii) Letter no. NRPC/AS/NRPC Fund/2019-20/10396dated 16.09.2019

Sir,

This is in continuation to NRPC's earlier communications as referred above. Copies of the same are also enclosed for ready reference. Despite our regular follow up, the contribution amount of Rs. 10 lakh for the year 2019-20 from your organisation is still awaited.

In view of the above, it is again requested to expedite the process for clearance of aforesaid contribution amount. The contribution can be made through Demand Draft, drawn in favour of "NRPC Fund" and may be forwarded to us. The contribution can also be deposited in any CBS branch of Punjab National Bank or through RTGS in the account named "NRPC Fund" (A/c No. 308300 0105096078) under intimation to us. The RTGS / NEFT Code is PUNB0308300.

Encl: As above

(वन्दिता शर्मा)

(Vandita Sharma)

VANDITA SHARMA  
Nodal Officer  
N.R.P.C., Fund

नोडल ऑफिसर-एन आर पी सी फण्ड

Nodal Officer-NRPC Fund

**REMINDER**

भारत सरकार  
Government of India

विद्युत मंत्रालय  
Ministry of Power

उत्तर क्षेत्रीय विद्युत समिति

**Northern Regional Power Committee**

No. NRPC/AS/NRPC Fund/2020-21 / 9010-9012

Dated: 11.09.2020

To

Sh. Rohit Kansal (IAS)  
Principal Secretary (Power),  
New Secretariat Srinagar, Govt. of UT of J&K  
0194-2506053/2506198 <md@jkspdcil.com>

**Subject:** Pending Contribution towards NRPC fund pertaining to PDD, J&K and J&K PDCL - reg.

- References:**
- (i) Reminder letters of even no. dated 17.01.2017, 14.08.2018, 16.10.2018, 08.03.2019, 16.09.2019, 31.10.2019 and 28.01.2020 i.r.o PDD J&K (copies enclosed as Annex-I)
  - (ii) Reminder letters of even no. dated 01.01.2015, 10.03.2015, 29.04.2015, 20.10.2015, 30.08.2017, 16.10.2018, 25.10.2018, 08.03.2019, 16.09.2019, 30.10.2019 and 28.01.2020 i.r.o J&K PDCL (copies enclosed as Annex-II)

Sir

This is in continuation to NRPC's earlier communications as referred above. Copies of the same are also enclosed for ready reference. Despite our regular follow up, the contribution amount of Rs. 27 lakh for the years 2016-17, 2018-19 and 2019-20 pertaining to PDD and Rs. 42 lakh for the years 2014-15, 2015-16, 2018-19 and 2019-20 pertaining to PDCL are still awaited. Further, NRPC in its 48<sup>th</sup> meeting decided a contribution amount of Rs. 6 lakh for each constituent for the year 2020-21. Accordingly, a total pending contribution including current FY for PDD and PDCL are Rs. 33 lakh and Rs. 48 lakh respectively.

Furthermore, in the recently held special meeting on 28.07.2020 to deliberate on issues related to UTs of J&K and Ladakh, the matter regarding aforesaid pending contribution was also discussed wherein J&K representative assured that all the pending contributions would be disbursed shortly.

In view of the above, it is again requested to expedite the process for clearance of aforesaid contribution amount. The contribution can be made through Demand Draft drawn in favour of "NRPC Fund" and may be forwarded to us. The contribution can also be deposited in any CBS branch of Punjab National Bank or through RTGS in the account named "NRPC Fund" (A/c No. 308300 0105096078) under intimation to us. The RTGS / NEFT Code is PUNB0308300

Encl: As above

  
(Naresh Bhandari)  
सदस्य सचिव  
Member Secretary

11/09/2020

Copy to: Chief Engineer (Trading), JKPCIL, PDD Complex, Baramulla, Srinagar



नरेश भण्डारी  
सदस्य सचिव

भारत सरकार  
विद्युत मंत्रालय  
उत्तर क्षेत्रीय विद्युत समिति  
18-ए, शहीद बीव सिंह मार्ग,  
कटारिया सराय, नई दिल्ली -110016  
दूरभाष . 26511211, 26513265

**REMINDER**

D.O NO. NRPC/AS/NRPCFUND/2019-20 (837)

Dated: 28/01/2020

Sh. M. Raju,

Please refer to my D.O. letter of even number dated 31<sup>st</sup> October, 2019 regarding payment of membership fee to the Northern Regional Power Committee (NRPC) by the constituent members of NRPC for the financial years 2019-20, 2018-19 and 2016-17 for meeting the annual expenditure of NRPC establishment.

2. In this regard I would like to mention that previously the amount of annual membership fee to be paid to the NRPC by each constituent member of the NRPC had been fixed as Rs.10 lakh. During the 45<sup>th</sup> NRPC meeting held recently on 08.06.2019, the amount of the annual membership fees the financial year 2019-20 also was decided to be fixed as Rs.10 Lakh for each constituent. NRPC Secretariat has already requested you vide its letters of even number dated 31.10.2019 for payment of the said contribution amounting to Rs.27 Lakh for the above cited financial years on urgent basis. The matter for payment of the above contribution has also discussed during the last few RPC meetings when Members of the Committee agreed to expedite the said payment. However, in spite of that the contribution from your organization in respect of the above cited financial years is still awaited.

3. Therefore, I shall be grateful if you could kindly intervene and arrange to expedite the amount of the aforesaid contribution amount of Rs.27 Lakh for smooth running of the NRPC Secretariat. The payment could be made either through Demand Draft, drawn in favour of "NRPC Fund" or through RTGS in the Bank account named "NRPC Fund" (A/c No. 3083000105096078 RTGS / NEFT Code: PUNB0308300).

Regards,

Yours Sincerely,

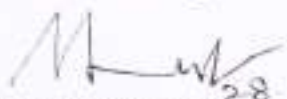
  
(Naresh Bhandari) 28-1-2020

Encl: As Above

To,  
Sh. M. Raju,  
Secretary Power,  
Power Development Department,  
Civil Secretariat,  
SRINAGAR (J&K)



नरेश भण्डारी  
सदस्य सचिव

भारत सरकार  
विद्युत मंत्रालय  
उत्तर क्षेत्रीय विद्युत समिति  
18-ए, शहीद जीत सिंह मार्ग,  
कटवारिया सराय, नई दिल्ली -110018  
दूरभाष . 26511211, 26513265

D.O NO. NRPC/AS/NRPCFUND/2019-20/13367

Dated: 31 /10/2019

Sh. Hirdesh Kumar,

The matter relates to pending payment of membership fee of the Northern Regional Power Committee (NRPC) for three years i.e. 2019-20, 2018-19 and 2016-17 for meeting the annual expenditure of NRPC establishment. PDD has not paid NRPC membership fee of Rs 17 lakh for the year 2018-19 and 2016-17. During 45<sup>th</sup> NRPC meeting held on 08.06.2019, the contribution amount was decided as Rs.10 Lakh for 2019-20. Accordingly, PDD is to make payment of Rs 27 lakh – Rs 10 lakh each for 2018-19, 2019-20 and Rs 7 lakh for 2016-17. In this regard, I would like to convey that NRPC Secretariat has communicated with your office, the copies of communication are enclosed.

I seek your kind intervention, for clearance of aforesaid contribution amount, on an early basis. The payment could be made through Demand Draft, drawn in favour of "NRPC Fund". The contribution can also be made through RTGS in the Bank account named "NRPC Fund" (A/c No. 3083000105096078 RTGS / NEFT Code: PUNB0308300).

With Regards,

Encl: As above

Yours Sincerely,

(Naresh Bhandari)

To,  
Sh. Hirdesh Kumar, IAS  
Secretary Power,  
Power Development Department,  
Civil Secretariat,  
SRINAGAR (J&K)





सत्यमेव जयते

भारत सरकार

उत्तर क्षेत्रीय विद्युत समिति

18-ए, श.जीत सिंह मार्ग, कटवारिया सराय,

नई दिल्ली- 110016

Government of India

Northern Regional Power Committee

18-A, S. Jeet Singh Marg, Katwaria Sarai,

New Delhi-110016

No. NRPC /AS/NRPC Fund/2019-20/10396

Date: 16.09.2019

To,

Principal Secretary to Govt.,  
Power Development Department,  
Civil Secretariat,  
**SRINAGAR-190009 (J&K)**

**Subject:** Contribution towards NRPC Fund for the year 2019-20 by the Constituents-  
regarding.

Sir,

This has reference to the minutes of 45<sup>th</sup> meeting of NRPC held on 08.06.2019 at Gangtok, Sikkim wherein members agreed to contribute a sum of Rs. 10.0 Lakh per member as contribution towards annual expenditure of NRPC secretariat for F.Y. 2019-20. Extracts of minutes of 45<sup>th</sup> meeting of NRPC is enclosed for ready reference.

It is, therefore, requested that the contribution of Rs. 10.0 lakh for the year 2019-20 in the form of Demand Draft in favour of "NRPC Fund" may be forwarded to us urgently. The contribution can also be deposited in any CBS branch of Punjab National Bank or through RTGS in the account named "NRPC Fund" (A/c No. 3083000105096078) under intimation to us. The RTGS / NEFT Code are PUNB0308300.

Encl: As above

Yours faithfully,

Nodal Officer, NRPC



नरेश भण्डारी  
सदस्य सचिव

भारत सरकार  
विद्युत मंत्रालय  
उत्तर क्षेत्रीय विद्युत समिति  
18-ए, शहीद जीत सिंह मार्ग,  
कटवारिया सराय, नई दिल्ली -110018  
दूरभाष . 26511211, 26513265

D.O NO. NRPC/AS/NRPCFUND/2019-20/13364

Dated: 31/10/2019

Sh. Hirdesh Kumar,

The matter relates to pending payment of membership fee of the Northern Regional Power Committee (NRPC) for four years i.e. 2019-20, 2018-19, 2015-16 and 2014-15 for meeting the annual expenditure of NRPC establishment. PDCL has not paid NRPC membership fee of Rs 32 lakh for the year 2018-19, 2015-16 and 2014-15. During 45<sup>th</sup> NRPC meeting held on 08.06.2019, the contribution amount was decided as Rs.10 Lakh for 2019-20. Accordingly, PDCL is to make payment of Rs 42 lakh – Rs 10 lakh each for 2018-19, 2019-20 and Rs 11 lakh each for 2015-16, 2014-15. In this regard, I would like to convey that NRPC Secretariat has communicated with your office, the copies of communication are enclosed.

I seek your kind intervention, for clearance of aforesaid contribution amount, on an early basis. The payment could be made through Demand Draft, drawn in favour of "NRPC Fund". The contribution can also be made through RTGS in the Bank account named "NRPC Fund" (A/c No. 3083000105096078 RTGS / NEFT Code: PUNB0308300).

With Regards,

Encl: As above

Yours Sincerely,

(Naresh Bhandari)

To,  
Sh. Hirdesh Kumar, IAS  
Secretary Power,  
J & K State Power Development Corp. Ltd.,  
Shaw Inn, the Boulevard,  
SRINAGAR-190009 (J&K)



नरेश भण्डारी  
सदस्य सचिव

भारत सरकार  
विद्युत मंत्रालय  
उत्तर क्षेत्रीय विद्युत समिति  
18-ए, शहीद जौहल सिंह मार्ग,  
कटवारिया सराय, नई दिल्ली -110016  
दूरभाष . 26511211, 26513265

**REMINDER**

D.O NO. NRPC/AS/NRPCFUND/2019-20/336

Dated: 28/01/2020

Sh. M. Raju,

Please refer to my D.O. letter of even number dated 31<sup>st</sup> October, 2019 regarding payment of membership fee to the Northern Regional Power Committee (NRPC) by the constituent members of NRPC for the financial years 2019-20, 2018-19, 2015-16 and 2014-15 for meeting the annual expenditure of NRPC establishment.

2. In this regard I would like to mention that previously the amount of annual membership fee to be paid to the NRPC by each constituent member of the NRPC had been fixed as Rs.10 lakh. During the 45<sup>th</sup> NRPC meeting held recently on 08.06.2019, the amount of the annual membership fees the financial year 2019-20 also was decided to be fixed as Rs.10 Lakh for each constituent. NRPC Secretariat has already requested you vide its letters of even number dated 31.10.2019 for payment of the said contribution amounting to Rs.42 Lakh for the above cited financial years on urgent basis. The matter for payment of the above contribution has also discussed during the last few RPC meetings when Members of the Committee agreed to expedite the said payment. However, in spite of that the contribution from your organization in respect of the above cited financial years is still awaited.

3. Therefore, I shall be grateful if you could kindly intervene and arrange to expedite the amount of the aforesaid contribution amount of Rs.42 Lakh for smooth running of the NRPC Secretariat. The payment could be made either through Demand Draft, drawn in favour of "NRPC Fund" or through RTGS in the Bank account named "NRPC Fund" (A/c No. 3083000105096078 RTGS / NEFT Code: PUNB0308300).

Regards,

Yours Sincerely,

  
(Naresh Bhandari) 28/1/2020

Encl: As Above

To,  
Sh. M. Raju,  
Secretary Power,  
J & K State Power Development Corp. Ltd.,  
Shaw Inn, the Boulevard,  
SRINAGAR-190009 (J&K)



सत्यमेव जयते

भारत सरकार

उत्तर क्षेत्रीय विद्युत समिति

18-ए, श.जीत सिंह मार्ग, कटवारिया सराय,

नई दिल्ली- 110016

Government of India

Northern Regional Power Committee

18-A, S. Jeet Singh Marg, Katwaria Sarai,  
New Delhi-110016

Phone: 26868681

Fax: 26865206

E-mail: seo-nrpc@nic.in

Website: [www.nrpc.gov.in](http://www.nrpc.gov.in)

No. NRPC /AS/NRPC Fund/2018-19/435

Date: 08.03.2019

To,

Managing Director,  
J & K State Power Development Corp. Ltd.,  
Shaw Inn, the Boulevard,  
**SRINAGAR-190009 (J&K)**

**Subject:** Contribution towards NRPC Fund for the year 2018-19 by the Constituents-regarding.

Sir,

Please refer to our letter of even number dated 16.10.2018 regarding contribution of Rs. 10.0 Lakh for contribution towards annual expenditure of NRPC Secretariat for financial year 2018-19.

It may be mentioned that during 42<sup>nd</sup> NRPC meeting of NRPC held on 28.06.2018 at Parwanoo, Solan(HP) wherein members agreed to contribute a sum of Rs. 10.0 Lakh per member as contribution towards annual expenditure of NRPC secretariat for F.Y. 2018-19. The contribution from your organisation is still awaited.

It is, therefore, requested that the contribution of Rs. 10.0 lakh for the year 2018-19 in the form of Demand Draft in favour of "NRPC Fund" may be forwarded to us urgently. The contribution can also be deposited in any CBS branch of Punjab National Bank or through RTGS in the account named "NRPC Fund" (A/c No. 3083000105096078) under intimation to us. The RTGS / NEFT Code are PUNB0308300.

Encl: As above

Yours faithfully,

Assistant Secretary



सत्यमेव जयते  
भारत सरकार

उत्तर क्षेत्रीय बिद्युत समिति  
18-ए, श.जीत सिंह मार्ग, कटवारिया सराय,  
नई दिल्ली- 110016  
Government of India  
Northern Regional Power Committee  
18-A, S. Jeet Singh Marg, Katwaria Sarai,  
New Delhi-110016

Phone: 26868681  
Fax: 26865206  
E-mail: seo-nrpc@nic.in  
Website: www.nrpc.gov.in

No. NRPC /AS/NRPC Fund/2018-19/ 1212

Date: 16.10.2018

To,

Managing Director,  
J & K State Power Development Corp. Ltd.,  
Shaw Inn, the Boulevard,  
SRINAGAR-190009 (J&K)

**Subject:** Contribution towards NRPC Fund for the year 2018-19 by the Constituents-  
regarding.

Sir,

This has reference to the minutes of 42<sup>nd</sup> meeting of NRPC held on 28.06.2018 at Parwanoo, Solan(HP) wherein members agreed to contribute a sum of Rs. 10.0 Lakh per member as contribution towards annual expenditure of NRPC secretariat for F.Y. 2018-19. Extracts of minutes of 42<sup>nd</sup> meeting of NRPC is enclosed for ready reference.

It is, therefore, requested that the contribution of Rs. 10.0 lakh for the year 2018-19 in the form of Demand Draft in favour of "NRPC Fund" may be forwarded to us urgently. The contribution can also be deposited in any CBS branch of Punjab National Bank or through RTGS in the account named "NRPC Fund" (A/c No. 3083000105096078) under intimation to us. The RTGS / NEFT Code are PUNB0308300.

Encl: As above

Yours faithfully,

Assistant Secretary

Phone: 26866681  
Fax: 26865206  
E-mail: nrpccommi@yahoo.com  
Website: [www.nrpc.gov.in](http://www.nrpc.gov.in)

भारत सरकार  
उत्तर क्षेत्रीय विद्युत समिति  
18-ए, श. जीत सिंह मार्ग, कटवारिया सराय,  
नई दिल्ली- 110016  
Government of India  
Northern Regional Power Committee  
18-A, S. Jeet Singh Marg, Katwaria Sarai,  
New Delhi-110016

No. NRPC /AS/NRPC Fund/2015-16/1777-80

Date: 30.08.2017

To,

Managing Director,  
J & K State Power Development Corp. Ltd.,  
Shaw Inn, The Boulevard,  
SRINAGAR-190009 (J&K)

**Subject:** Contribution towards NRPC Fund for the year 2015-16 by the Constituents-  
regarding.

Sir,

Please refer to our letter of even number dated 27.08.2015, 09.12.2015 & 08.02.2016 regarding contribution of Rs. 11.0 Lakh for contribution towards annual expenditure of NRPC Secretariat for financial year 2015-16

It may be mentioned that during the 35<sup>th</sup> NRPC meeting held on 09.07.2015 at Shimla, members agreed to contribute Rs. 11.0 Lakh per member as contribution towards annual expenditure of NRPC secretariat for financial year 2015-16. The contribution from your organisation is still awaited.

It is, therefore, requested that the contribution of Rs. 11.0 lakh for the year 2015-16 in the form of Demand Draft in favour of "NRPC Fund" may be forwarded to us urgently. The contribution can also be deposited in any CBS branch of Punjab National Bank or through RTGS in the account named "NRPC Fund" (A/c No. 3083000105096078) under intimation to us. The RTGS / NEFT Code is PUNB0308300.

Yours faithfully,

  
Assistant Secretary



सत्यमेव जयते

भारत सरकार

उत्तर क्षेत्रीय विद्युत समिति

18-ए, श.जीत सिंह मार्ग, कटवारिया सराय,

नई दिल्ली- 110016

Government of India

Northern Regional Power Committee

18-A, S. Jeet Singh Marg, Katwaria Sarai,

New Delhi-110016

Phone: 26868681  
Fax: 26865206  
E-mail: [soo-nrpc@nic.in](mailto:soo-nrpc@nic.in)  
Website: [www.nrpc.gov.in](http://www.nrpc.gov.in)

No. NRPC/AS/NRPC Fund/2018-19/ 12316

Date: 25.10.2018

To,

Managing Director,  
J & K State Power Development Corp. Ltd.  
Hotel Shaw Inn, The Boulevard,  
SRINAGAR-190009 (J&K)

**Subject:** Reimbursement of NRPC establishment expenditure for FY 2014-15 by J & K State Power Development Corporation Limited.

Sir,

In the 30<sup>th</sup> NRPC meeting held on 28.02.2014 at Agra, members agreed to contribute Rs. 11.0 Lakh per member as contribution towards annual expenditure of NRPC secretariat for financial year 2014-15. Despite repeated requests and regular follow up in various NRPC meetings, the contribution from J & K State Power Development Corp. Ltd. is pending till date.

NRPC establishment expenditure is met against the NRPC allocated budget and the same is reimbursed to consolidated fund of India after collection from the NRPC constituents. There is serious objection from Audit on non recovery of dues from some of the NRPC constituents.

It is, therefore, requested that J & K State Power Development Corp. Ltd. may be directed to make the contribution of Rs. 11.0 lakh for the year 2014-15 in the form of Demand Draft in favour of "NRPC Fund" or deposit in any CBS branch of Punjab National Bank or through RTGS in the account named "NRPC Fund" (A/c No. 3083000105096078) under intimation to us [The RTGS / NEFT Code is PUNB0308300] urgently.

Yours faithfully,

  
Assistant Secretary

Phone: 26868681  
Fax: 26865206  
E-mail: nrpccommi@yahoo.com  
Website: www.nrpc.gov.in

भारत सरकार  
उत्तर क्षेत्रीय विद्युत समिति  
18-ए, श.जीत सिंह मार्ग, कटवारिया सराय,  
नई दिल्ली- 110016  
Government of India  
Northern Regional Power Committee  
18-A, S. Jeet Singh Marg, Katwaria Sarai,  
New Delhi-110016

No. NRPC/AS/NRPC Fund/2015-16/1093-99

Date: 20.10.2015

To,

Managing Director,  
J & K State Power Development Corp. Ltd.  
Hotel Shaw Inn, The Boulevard,  
SRINAGAR-190009 (J&K)

**Subject:** Contribution towards NRPC Fund for the year 2014-15 by the Constituents-  
regarding.

Sir,

Please refer to our letter of even number dated 09.06.2014, 30.12.2014, 10.03.2015 & 28.04.2015 regarding contribution of Rs. 11.0 Lakh for contribution towards annual expenditure of NRPC Secretariat for financial year 2014-15

It may be mentioned that during the 30<sup>th</sup> NRPC meeting held on 28.02.2014 at Agra, members agreed to contribute Rs. 11.0 Lakh per member as contribution towards annual expenditure of NRPC secretariat for financial year 2014-15. The contribution from your organisation is awaited.

It is, therefore, requested that the contribution of Rs. 11.0 lakh for the year 2014-15 in the form of Demand Draft in favour of "NRPC Fund" may be forwarded to us urgently. The contribution can also be deposited in any CBS branch of Punjab National Bank or through RTGS in the account named "NRPC Fund" (A/c No. 3083000105096078) under intimation to us. The RTGS / NEFT Code is PUNB0308300.

Yours faithfully,

  
Assistant Secretary



Phone: 26868681  
Fax: 26865206  
E-mail: nrpccommi@yahoo.com  
Website: [www.nrpc.gov.in](http://www.nrpc.gov.in)

भारत सरकार  
उत्तर क्षेत्रीय विद्युत समिति  
18-ए, श.जीत सिंह मार्ग, कटवारिया सराय,  
नई दिल्ली- 110016  
Government of India  
Northern Regional Power Committee  
18-A, S. Jeet Singh Marg, Katwaria Sarai,  
New Delhi-110016

No. NRPC/AS/NRPC Fund/2015-16/720-31

Date: 28.04.2015  
29

To,

Managing Director,  
J & K State Power Development Corp. Ltd.  
Hotel Shaw Inn, The Boulevard,  
SRINAGAR-190009 (J&K)

**Subject:** Contribution towards NRPC Fund for the year 2014-15 by the Constituents-  
regarding.

Sir,

Please refer to our letter of even number dated 09.06.2014, 30.12.2014 & 10.03.2015 regarding contribution of Rs. 11.0 Lakh for contribution towards annual expenditure of NRPC Secretariat for financial year 2014-15

It may be mentioned that during the 30<sup>th</sup> NRPC meeting held on 28.02.2014 at Agra, members agreed to contribute Rs. 11.0 Lakh per member as contribution towards annual expenditure of NRPC secretariat for financial year 2014-15. The contribution from your organisation is awaited.

It is, therefore, requested that the contribution of Rs. 11.0 lakh for the year 2014-15 in the form of Demand Draft in favour of "NRPC Fund" may be forwarded to us urgently. The contribution can also be deposited in any CBS branch of Punjab National Bank or through RTGS in the account named "NRPC Fund" (A/c No. 3083000105096078) under intimation to us. The RTGS / NEFT Code is PUNB0308300.

Yours faithfully,

  
Assistant Secretary

Phone: 26868681  
Fax: 26865206  
E- mail: nrpccommi@yahoo .com  
Website: [www.nrpc.gov.in](http://www.nrpc.gov.in)

भारत सरकार  
उत्तर क्षेत्रीय विद्युत समिति  
18-ए, श.जीत सिंह मार्ग, कटवारिया सराय,  
नई दिल्ली- 110016  
Government of India  
Northern Regional Power Committee  
18-A, S. Jeet Singh Marg, Katwaria Sarai,  
New Delhi-110016

No. NRPC /AS/NRPC Fund/2014-15/477-90

Date: 10.03.2015

To,

Managing Director,  
J & K State Power Development Corp. Ltd.  
Hotel Shaw Inn, The Boulevard,  
SRINAGAR-190009 (J&K)

**Subject:** Contribution towards NRPC Fund for the year 2014-15 by the Constituents-  
regarding.

Sir,

Please refer to our letter of even number dated 09.06.2014 & 30.12.2014 regarding contribution of Rs. 11.0 Lakh for contribution towards annual expenditure of NRPC Secretariat for financial year 2014-15

It may be mentioned that during the 30<sup>th</sup> NRPC meeting held on 28.02.2014 at Agra, members agreed to contribute Rs. 11.0 Lakh per member as contribution towards annual expenditure of NRPC secretariat for financial year 2014-15. The contribution from your organisation is awaited.

It is, therefore, requested that the contribution of Rs. 11.0 lakh for the year 2014-15 in the form of Demand Draft in favour of "NRPC Fund" may be forwarded to us urgently. The contribution can also be deposited in any CBS branch of Punjab National Bank or through RTGS in the account named "NRPC Fund" (A/c No. 3083000105096078) under intimation to us. The RTGS / NEFT Code is PUNB0308300.

Yours faithfully,

  
16.03.15  
Assistant Secretary

Phone: 26866681  
Fax: 26865208  
E-mail: nrpcocomm@yahoo.com  
Website: www.nrpc.gov.in

भारत सरकार  
उत्तर क्षेत्रीय विद्युत समिति  
18-ए, श.जीत सिंह मार्ग, कटवारिया सराय,  
नई दिल्ली- 110016  
Government of India  
Northern Regional Power Committee  
18-A, S. Jeet Singh Marg, Katwaria Sarai,  
New Delhi-110016

No. NRPC /AS/NRPC Fund/2014-15/01-15

Date: 30.12.2014  
01.01.2015

To,

Managing Director,  
J & K State Power Development Corp. Ltd.  
Hotel Shaw Inn, The Boulevard,  
SRINAGAR-190009 (J&K)

**Subject:** Contribution towards NRPC Fund for the year 2014-15 by the Constituents-  
regarding.

Sir,

Please refer to our letter of even number dated 09.06.2014 regarding contribution of Rs. 11.0 Lakh for contribution towards annual expenditure of NRPC Secretariat for financial year 2014-15

It may be mentioned that during the 30<sup>th</sup> NRPC meeting held on 28.02.2014 at Agra, members agreed to contribute Rs. 11.0 Lakh per member as contribution towards annual expenditure of NRPC secretariat for financial year 2014-15. The contribution from your organisation is awaited.

It is, therefore, requested that the contribution of Rs. 11.0 lakh for the year 2014-15 in the form of Demand Draft in favour of "NRPC Fund" may be forwarded to us urgently. The contribution can also be deposited in any CBS branch of Punjab National Bank or through RTGS in the account named "NRPC Fund" (A/c No. 3083000105096078) under intimation to us. The RTGS / NEFT Code is PUNB0308300.

Yours faithfully,

  
Assistant Secretary

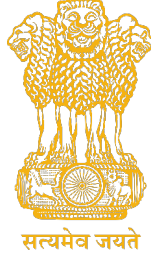

**उत्तर क्षेत्रीय विद्युत समिति**  
**NORTHERN REGIONAL POWER COMMITTEE**



**Protection Philosophy/Protocol  
of Northern Region**

*(developed in compliance of IEGC 2023)*

**Version: 2.0**

*(approved in 71st NRPC meeting held on 29.01.2024)*

**January 2024**

*Protection Philosophy/Protocol of Northern Region  
(approved in 71st NRPC meeting held on 29.01.2024)*

S.N.	Protection Setting/Protocol	Mandated Setting for transmission lines
1	Protection Scheme	<p><b>220kV and above:</b> Independent Main-I and Main-II protection (of different make OR different type/different algorithm) of non-switched numerical type is to be provided with carrier aided scheme.</p> <p><b>132kV and below:</b> One non-switched distance protection scheme and, directional over current and earth fault relays, should be provided as back up.</p>
2	Distance Protection Zone-1	<p>Reach: 80% of the protected line; 110% of the protected line (In case of radial lines) Time Setting: Instantaneous.</p>
3	Distance Protection Zone-2	<p>Reach: Single Circuit Line: 120% of length of principle line section. Double circuit line: 150% coverage of line to take care of under reaching due to mutual coupling effect.</p> <p>Time setting:</p> <ul style="list-style-type: none"> <li>i. 0.35 second <i>(considering LBB time of 200mSec, CB open time of 60ms, resetting time of 30ms and safety margin of 60ms)</i></li> <li>ii. 0.5-0.6 second <i>(For a long line followed by a short line)</i></li> </ul>

*Protection Philosophy/Protocol of Northern Region  
(approved in 71st NRPC meeting held on 29.01.2024)*

<b>4</b>	<b>Distance Protection Zone-3</b>	<p>Reach: Zone-3 should overreach the remote terminal of the longest adjacent line by an acceptable margin (typically 20% of highest impedance seen) for all fault conditions.</p> <p>Time Setting: 800-1000 msec</p> <p>If zone-3 reach transcends to other voltage level, time may be taken upto 1.5 sec.</p>
<b>5</b>	<b>Distance Protection Zone- 4</b>	<p>The Zone-4 reverse reach must adequately cover expected levels of apparent bus bar fault resistance.</p> <p>Time may be coordinated accordingly.</p> <p>Where Bus Bar protection is not available, time setting: 160 msec.</p>
<b>6</b>	<b>Lines with Series and other compensations in the vicinity of Substation</b>	<ul style="list-style-type: none"> <li>• Zone-1: FSC end: 60% of the protected line. Time: Instantaneous; Remoted end: 60% of the protected line with 100ms-time delay. POR Communication scheme logic is modified such that relay trips instantaneously in Zone-1 on carrier receive.</li> <li>• Zone-2: 120 % of uncompensated line impedance for single circuit line. For Double circuit line, settings may be decided on basis of dynamic study in view of zero sequence mutual coupling.</li> <li>• Phase locked voltage memory is used to cope with the voltage inversion. Alternatively, an intentional time delay may be applied to overcome directionality problems related to voltage inversion.</li> </ul>

*Protection Philosophy/Protocol of Northern Region  
(approved in 71st NRPC meeting held on 29.01.2024)*

		<ul style="list-style-type: none"> <li>over-voltage stage-I setting for series compensated double circuit lines may be kept higher at 113%.</li> </ul>
<b>7</b>	<b>Power Swing Blocking</b>	<p>Block tripping in all zones, all lines.</p> <p>Out of Step tripping to be applied on all inter-regional tie lines.</p> <p>Deblock time delay = 2s</p>
<b>8</b>	<b>Protection for broken conductor</b>	<p>Negative Sequence current to Positive Sequence current ratio more than 0.2 (i.e. <math>I_2/I_1 \geq 0.2</math>)</p> <p>Alarm Time delay: 3-20 sec.</p> <p>Tripping may be considered for radial lines to protect single phasing of transformers.</p>
<b>9</b>	<b>Switch on to fault (SOTF)</b>	<p>Switch on to fault (SOTF) function to be provided in distance relay to take care of line energization on fault.</p>
<b>10</b>	<b>VT fuse fail detection function</b>	<p>VT fuse fail detection function shall be correctly set to block the distance function operation on VT fuse failure.</p>
<b>11</b>	<b>Carrier Protection</b>	<p>To be applied on all 220kV and above lines with the only exception of radial feeders.</p>
<b>12</b>	<b>Back up Protection</b>	<ol style="list-style-type: none"> <li>On 220kV and above lines with 2 Main Protections: <ul style="list-style-type: none"> <li>Back up Earth Fault protections alone to be provided.</li> <li>No Over current protection to be applied.</li> </ul> </li> <li>At 132kV and below lines with only one Main protection: <ul style="list-style-type: none"> <li>Back up protection by IDMT O/C and E/F to be applied.</li> </ul> </li> </ol>
<b>13</b>	<b>Auto Reclosing with dead</b>	<p>AR shall be enabled for 220 kV and above lines for single pole trip and re-closing.</p> <p>Dead time = 1.0s. Reclaim time = 25.0s</p>

*Protection Philosophy/Protocol of Northern Region  
(approved in 71st NRPC meeting held on 29.01.2024)*

	<b>time.</b>	<p>Auto-recloser shall be blocked for following:</p> <ol style="list-style-type: none"> <li>i. faults in cables</li> <li>ii. Breaker Fail Relay</li> <li>iii. Line Reactor Protections</li> <li>iv. O/V Protection</li> <li>v. Received Direct Transfer trip signals</li> <li>vi. Busbar Protection</li> <li>vii. Zone 2/3 of Distance Protection</li> <li>viii. Circuit Breaker Problems.</li> </ol> <p>CB Pole discrepancy relay time:1.5 sec; for tie breaker: 2.5 sec</p>
<b>14</b>	<b>Busbar protection</b>	To be applied on all 220kV and above sub stations with the only exception of 220kV radial fed bus bars.
<b>15</b>	<b>Local Breaker Backup (LBB)</b>	<p>For 220 kV and above level substations as well as generating stations switchyards, LBB shall be provided for each circuit breaker.</p> <p>LBB Current sensor <math>I &gt; 20\% I_n</math></p> <p>LBB time delay = 200ms</p> <p>In case of variation in CT ratio, setting may be done accordingly.</p>
<b>16</b>	<b>Line Differential</b>	<p>For cables and composite lines, line differential protection with built in distance back up shall be applied as Main-I protection and distance relay as Main-II protection.</p> <p>For very short line (less than 10 km), line differential protection with distance protection as backup (built-in Main relay or standalone) shall be provided mandatorily as Main-I and Main-II.</p> <p>Differential protection may be done using dark fiber</p>



*Protection Philosophy/Protocol of Northern Region  
(approved in 71st NRPC meeting held on 29.01.2024)*

		(preferably), or using bandwidth.
<b>17</b>	<b>Over Voltage Protection</b>	<p>FOR 765kV LINES/CABLE:  Low set stage (Stage-I): 106% - 109% (typically 108%) with a time delay of 5 seconds.  High set stage (Stage-II): 140% - 150% with a time delay of 100 milliseconds.</p> <p>400kV LINES/CABLE:  Low set stage (Stage-I): 110% - 112% (typically 110%) with a time delay of 5 seconds.  High set stage (Stage-II): 140% - 150% with a time delay of 100 milliseconds.</p> <p>FOR 220 KV LINES:  No over-voltage protection shall be used.</p> <p>FOR 220 KV CABLE:  Low set stage (Stage-I): 110% - 112% (typically 110%) with a time delay of 5 seconds.  High set stage (Stage-II): 140% - 150% with a time delay of 100 milliseconds.</p> <p>Drop-off to pick-up ratio of overvoltage relay:  better than 97%</p> <p>Grading: Voltage as well as time grading may be done for multi circuit lines/cable.</p>
<b>18</b>	<b>Resistive reach setting to prevent load point encroachment</b>	<p>Following criteria may be considered for deciding load point encroachment:</p> <ul style="list-style-type: none"> <li>• Maximum load current (<math>I_{max}</math>) may be considered as 1.5 times the thermal rating of the line or 1.5 times the associated bay equipment current</li> </ul>

*Protection Philosophy/Protocol of Northern Region  
(approved in 71st NRPC meeting held on 29.01.2024)*

		<p>rating (the minimum of the bay equipment individual rating) whichever is lower. (Caution: The rating considered is approximately 15minutes rating of the transmission facility).</p> <ul style="list-style-type: none"> <li>• Minimum voltage (<math>V_{min}</math>) to be considered as 0.85pu (85%).</li> </ul>
<b>19</b>	<b>Direct Inter-trip</b>	<p>To be sent on operation of following:</p> <ol style="list-style-type: none"> <li>i. Overvoltage Protection</li> <li>ii. LBB Protection</li> <li>iii. Busbar Protection</li> <li>iv. Reactor Protection</li> <li>v. Manual Trip (400 kV and above)</li> <li>vi. Cable Fault (in composite lines)</li> </ol>
<b>20</b>	<b>Permissive Inter-trip</b>	To be sent on operation of Distance Protection

\*\*\*\*\*

**REQUEST FOR PROPOSAL  
DOCUMENT**

**FOR**

**SELECTION OF  
TRANSMISSION SERVICE PROVIDER**

**THROUGH TARIFF BASED COMPETITIVE BIDDING PROCESS**

**TO**

**ESTABLISH TRANSMISSION SYSTEM**

**FOR**

**“Construction of 765/400/220 kV GIS Substation, Meerut with associated lines and 400/220/132 kV GIS Substation, Simbhaoli with associated Transmission lines”**

**ISSUED BY**



(A wholly owned subsidiary of Power Finance Corporation Ltd.)

**PFC CONSULTING LIMITED**

**(A wholly owned subsidiary of Power Finance Corporation Ltd.)**

Corporate Office:

9th Floor, A-Wing, Statesman House  
Connaught Place, New Delhi – 110 001

**June 17, 2019**

## 1. INTRODUCTION

- 1.1 U.P Power Transmission Corporation Ltd. (UPPTCL) vide its letter no. 62/PS/DIR(W&P)/PTCL/Meerut&Simbhavali dated March 06, 2019 has notified PFC Consulting Limited as Bid Process Coordinator (BPC) for the purpose of selection of Bidder as Transmission Service Provider (TSP) to establish transmission system for “**Construction of 765/400/220 kV GIS Substation, Meerut with associated lines and 400/220/132 kV GIS Substation, Simbhaoli with associated Transmission lines**” through tariff based competitive bidding process.
- 1.2 The BPC now invites Bids for selection of Transmission Service Provider to establish the Transmission System as detailed below in the table for “**Construction of 765/400/220 kV GIS Substation, Meerut with associated lines and 400/220/132 kV GIS Substation, Simbhaoli with associated Transmission lines**”(hereinafter referred to as 'Project') on build, own, operate and maintain basis, and to provide transmission service on a long term basis to the Long Term Transmission Customers, as listed out in Annexure-1 of this RFP. The BPC reserves the right to add, delete or replace any Long Term Transmission Customer(s) to the list.

### (A) 765/400/220kV GIS substation, Meerut with associated lines :-

Sl. No.	Name of the transmission element	Completion Target	Conductor per phase
1.	Construction of 765/400/220kV GIS substation (2x1500+2x500MVA), Meerut with following Bays :- (i) 765kV, 1500MVA ICT Bay - 02 nos. (ii) 765kV, 240MVAR Bus Reactor Bay - 01 no. (iii) 400kV, 1500MVA ICT Bay - 02 nos. (iv) 400kV, 500MVA ICT Bay - 02 nos. (v) 400kV, 80MVAR Bus Reactor Bay - 01 no. (vi) 220kV, 500MVA ICT Bay - 02 nos. (vii) 765kV Feeder Bay - 02 nos. (viii) 400kV Feeder Bay - 04 nos. (ix) 220kV Feeder Bay - 06 nos.	31.08.2021	
2.	Construction of following additional bays for future extension :- (i) 765kV Feeder Bay - 02 nos. (ii) 400kV Feeder Bay - 02 nos. (iii) 220kV Feeder Bay - 04 nos. (iv) 765kV T/F Bay - 01 no. (v) 400kV T/F Bay - 02 nos. (vi) 220kV T/F Bay - 01 no.		

3.	LILOf 765kV S/C Gr. Noida (765kV) – Hapur (765kV) (WUPPTCL) at 765kV substation, Meerut	31.08.2021	<b>Quad BERSIMIS ACSR</b> The transmission lines shall have to be designed for a maximum operating conductor temperature of 85 deg C for ACSR.
----	---	------------	---

**B) 400/220/132kV GIS substation, Simbhaoli with associated lines:-**

Sl. No.	Name of the transmission element	Completion Target	Conductor per phase
1.	Construction of 400/220/132kV GIS substation (2x500+2x200MVA), Simbhaoli with following Bays:- i. 400kV ICT Bay - 02 nos. ii. 400kV, 80MVAR Bus Reactor Bay - 01 no. iii. 220kV ICT Bay - 04 nos. iv. 132kV ICT Bay - 02 nos. v. 400kV Feeder Bay - 04 nos. vi. 220kV Feeder Bay - 02 nos. vii. 132kV Feeder Bay - 02 nos.	31.05.2021	
2.	Construction of following additional bays for future extension :- i. 400kV Feeder Bay - 02 nos. ii. 220kV Feeder Bay - 04 nos. iii. 132kV Feeder Bay - 04 nos. iv. 400kV T/F Bay - 01 no. v. 220kV T/F Bay - 02 nos. vi. 132kV T/F Bay - 01 no.		
3.	Simbhaoli (400kV) – Muradnagar-II (Ghaziabad) 400kV DC Line (Twin Moose)	31.05.2021	<b>Twin Moose</b>
4.	Simbhaoli (400kV) – Meerut (765kV) 400kV DC Line (Twin Moose)	31.08.2021	<b>Twin Moose</b>

**Note:**

- (1) *In case of any augmentation work in future at the substation/line being developed by the TSP, no supervision charges shall be payable to TSP.*
- (2) *Land of 765kV Meerut and 400kV Simbhaoli substation shall be arranged by the developer at its own cost, keeping following points in consideration:-*

**TRANSMISSION SERVICE AGREEMENT**

**FOR**

**PROCUREMENT OF TRANSMISSION SERVICES**

**FOR**

**TRANSMISSION OF ELECTRICITY THROUGH  
TARIFF BASED COMPETITIVE BIDDING**

**FOR**

**“Construction of 765/400/220 kV GIS Substation, Meerut with associated lines and 400/220/132 kV GIS Substation, Simbhaoli with associated Transmission lines”**

**BETWEEN**

 Pashchimanchal Vidhut Vitran Nigam Limited

**AND**

Purvanchal Vidhut Vitran Nigam Limited 

**AND**

 Dashinanchal Vidhut Vitran Nigam Limited

**AND**

 Madhyanchal Vidhut Vitran Nigam Limited

**AND**

Kanpur Electricity Supply Co. Limited 

**AND**

Meerut-Simbhawali Transmission Limited 

## Schedule : 3

## Scheduled COD

[Note: As referred to in the definition of "Element", "Scheduled COD", and in Articles 3.1.3 (c), 4.1 (b) and 4.3 (a) of this Agreement]

All Elements of the Project are required to be commissioned progressively as per the schedule given in the following table;

Sl. No.	Name of the Transmission Element	Scheduled COD from Effective Date	Percentage of Quoted Transmission Charges recoverable on Scheduled COD of the Element of the Project	Element(s) which are pre-required for declaring the commercial operation (COD) of the respective Element
<b>A. 765/400/220kV GIS substation, Meerut with associated lines :-</b>				
(1)	Construction of 765/400/220kV GIS substation, Meerut with following Bays :- (i) 765kV, 1500MVA ICT Bay - 02 nos. (ii) 765kV, 240MVAR Bus Reactor Bay - 01 no. (iii) 400kV, 1500MVA ICT Bay - 02 nos. (iv) 400kV, 500MVA ICT Bay - 02 nos. (v) 400kV, 80MVAR Bus Reactor Bay - 01 no. (vi) 220kV, 500MVA ICT Bay - 02 nos. (vii) 765kV Feeder Bay - 02 nos. (viii) 400kV Feeder Bay - 04 nos. (ix) 220kV Feeder Bay - 06 nos.	31.08.2021	41.49%	Elements at Sl. No. 1 & 3 shall be required simultaneously.

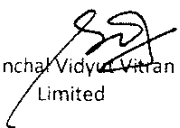
  
Pashchimanchal Vidyut Vitran Nigam  
Limited

  
Madhyanchal Vidyut Vitran Nigam Limited

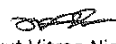
  
Purvanchal Vidyut Vitran Nigam  
Limited

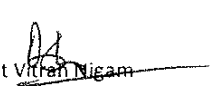
  
Dashinanchal Vidyut Vitran Nigam  
Limited

  
Kanpur Electricity Supply Co. Limited

  
Meerut-Simbhavali Transmission  
Limited

(2)	Construction of following additional bays for future extension :- (i) 765kV Feeder Bay - 02 nos. (ii) 400kV Feeder Bay - 02 nos. (iii) 220kV Feeder Bay - 04 nos. (iv) 765kV T/F Bay - 01 no. (v) 400kV T/F Bay - 02 nos. (vi) 220kV T/F Bay - 01 no.			
(3)	LILO of 765kV S/C Gr. Noida (765kV) – Hapur (765kV) (WUPPTCL) at 765kV substation, Meerut		18.91%	
<b>B. 400/220/132kV GIS substation, Simbhaoli with associated lines:-</b>				
(1)	Construction of 400/220/132kV GIS substation, Simbhaoli with following Bays:- vii. 400kV ICT Bay - 02 nos. viii. 400kV, 80MVAR Bus Reactor Bay - 01 no. ix. 220kV ICT Bay - 04 nos. x. 132kV ICT Bay - 02 nos. xi. 400kV Feeder Bay - 04 nos. xii. 220kV Feeder Bay - 02 nos. xiii. 132kV Feeder Bay - 02 nos.	31.05.2021	20.79%	Elements at Sl. No. 1 & 3 shall be required simultaneously.

  
Pashchimanchal Vidyut Vitran Nigam Limited

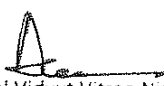
  
Madhyanchal Vidyut Vitran Nigam Limited

  
Purvanchal Vidyut Vitran Nigam Limited

  
Dashinanchal Vidyut Vitran Nigam Limited

  
Kanpur Electricity Supply Co. Limited

  
Meerut-Simbhawali Transmission Limited



(2)	Construction of following additional bays for future extension :- vii. 400kV Feeder Bay - 02 nos. viii. 220kV Feeder Bay - 04 nos. ix. 132kV Feeder Bay - 04 nos. x. 400kV T/F Bay - 01 no. xi. 220kV T/F Bay - 02 nos. xii. 132kV T/F Bay - 01 no.			
(3)	Simbhaoli (400kV) – Muradnagar-II (Ghaziabad) 400kV DC Line (Twin Moose)		13.24%	
(4)	Simbhaoli (400kV) – Meerut (765kV) 400kV DC Line (Twin Moose)	31.08.2021	5.57%	

The payment of Transmission Charges for any Element irrespective of its successful commissioning on or before its Scheduled COD shall only be considered after successful commissioning of the Element(s) which are pre-required for declaring the commercial operation of such Element as mentioned in the above table.

**Note:**

(1) In case of any augmentation work in future at the substation/line being developed by the TSP, no supervision charges shall be payable to TSP.

(2) Land of 765kV Meerut and 400kV Simbhaoli substation shall be arranged by the developer at its own cost, keeping following points in consideration:-

(d) Land for 765kV substation Meerut shall be procured in the vicinity of village Asifabad, Kila Parikshitgarh under Hastinapur Vidhan Sabha area.

(e) Land for 400kV substation Simbhavli shall be procured in the vicinity of village Nawada Khurd Khadar under Garh Mukteshwar Vidhan Sabha area.

  
Pashchimanchal Vidyut Vitran Nigam  
Limited

  
Madhyanchal Vidyut Vitran Nigam Limited

  
Purvanchal Vidyut Vitran Nigam  
Limited

  
Dashinanchal Vidyut Vitran Nigam  
Limited

  
Kanpur Electricity Supply Co. Limited

  
Meerut-Simbhawali Transmission  
Limited

(f) Selection of land should be such that the variation in line lengths of different voltage level should not exceed  $\pm 10\%$ .

(3) The developer shall complete the substation in all respect with main bays including ICT's, PLCC & FOTE equipments.

(4) 765kv LILO Line shall be constructed as 2No.765kv single circuit lines.

However construction of future additional bays shall be in the scope of developer and shall complete the bays in all respect except ICT's and PLCC equipment.

**Scheduled COD for overall Project : August 31, 2021.**

  
Pashchimanchal Vidyut Vitran Nigam  
Limited

  
Madhyanchal Vidyut Vitran Nigam Limited

  
Purvanchal Vidyut Vitran Nigam  
Limited

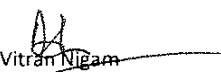
  
Dashinanchal Vidyut Vitran Nigam  
Limited

  
Kanpur Electricity Supply Co. Limited

  
Meerut-Simbhavali Transmission  
Limited

**pstcl** PUNJAB STATE TRANSMISSION CORPORATION LTD.  
(PUNJAB GOVERNMENT UNDERTAKING)

Regd. Office : PSEB HEAD OFFICE, THE MALL, PATIALA-147001, Punjab, India  
Office of Dy. Chief Engineer/Planning, Shakti Sadan, Patiala

Corporate Identity Number : U40109PB2010SGC033814

Telephone: 0175-2970047

e-mail: ce-tl@pstcl.org.

Fax No.0175- 2970047

To

Member Secretary NRPC,  
18-A, Shaheed Jeet Singh Marg,  
Katwaria Sarai,  
New Delhi-110016

Memo No. 109 /

Dated 24-01-2024

**Sub:- Inclusion of agenda item in the upcoming NRPC meeting.**

**Agenda item:- Tapping arrangement for LILO of one ckt.(CKT-II) of existing 400KV D/C Ludhiana-Koldam line at proposed 400KV Substation Ropar.**

- 1.0 The work of construction of 400KV Line i.e LILO of 400KV Ludhiana-Koldam line (CKT-II) at 400KV Ropar is in full swing. 400KV D/C Ludhiana-Koldam Transmission line is being operated by JV of PGCIL and PKTCL (Parbati koldam Transmission Company limited, PKTCL). PSTCL has requested PKTCL vide letter memo no. 2200 dated 14.09.2023 (**Annexure-A**) to accord the necessary approval for tapping arrangement at tapping tower no.161 of the 400KV Ludhiana- Koldam Line. However, PKTCL vide their letter dated 16.12.2023 (**Annexure-B**) has responded that:-

*CEA (Measures relating to safety and Electricity Supply) Regulation, 2023, Regulation 46(4) restricts tapping of transmission of voltage level 66KV & above. Citation of same is given below:-*

*"There shall not be tapping of another transmission line from the main line for 66 KV and above class of line: Provided that during natural calamities, tapping may be allowed to ensure emergency power supply to affected areas till normalcy restored."*

*In view of this, following is proposed:-*

*Loop- in should be done through tower no.159 & Loop-out should be done through tower no.161 of existing 400KV D/C Ludhiana-Koldam Transmission Line (CKT-II). The Span of either side of PSTCL Tower No.1 shall be more than 400 Meters. If required, additional tower must be provided between existing Tower no.159/161 of PKTCL & Tower no.1 of PSTCL for maintenance of adequate ground clearance and live metal clearances.*

- 1.1 In this regard it is apprised that the CEA (Measures relating to safety and Electricity Supply) Regulation, 2023(Annexure-C) is an updation to CEA (Measures relating to safety and Electricity Supply) Regulation, 2010(Annexure-D), wherein, guidelines for tapping arrangement is unchanged i.e guidelines for tapping arrangement in CEA (Measures relating to safety and Electricity Supply) Regulation, 2010 & CEA (Measures relating to safety and Electricity Supply) Regulation, 2023 are same.
- 1.2 It is pertinent to mention here that recently, in case of the LILO of 400 KV Jalandhar-Kuruksetra (PGCIL) line at 400 KV Dhanansu (PSTCL), PGCIL has given the approval for tapping arrangement in the same pattern vide their letter no. N2MLK/TL/PSTCL/2021/95 dated 25.10.2021(Annexure-E).
- 1.3 The Maximum span for the design configuration of towers of PSTCL is 375 m therefore, it cannot be used for more that 400m span.
- 1.4 All the supply of material has already been taken. The stubbing of 21 out of 23 tower locations has been completed & erection of 9 Nos. towers including tapping Tower No.1 has been completed. The Construction work of line is in full swing and this transmission line is utmost importance for increasing reliability and transmission capacity in the region, whose progress is monitored at the highest level.
- 1.5 In view of above facts, it is proposed to provide the approval for tapping arrangement for this 400KV line i.e LILO of 400KV Ludhian-Koladam line(CKT-II) at 400KV Ropar in the same pattern as in case of LILO of 400 KV Jalandhar-Kuruksetra (PGCIL) line at 400 KV Dhanansu (PSTCL).

In view of the above, it is requested to include the above-mentioned agenda point in the upcoming NRPC meeting.

Thanks and regards.

  
Chief Engineer/TS,  
PSTCL, Patiala.



**PUNJAB STATE TRANSMISSION CORPORATION LIMITED**

Head Office : PSEB Head Office, The Mall, Patiala 147001

Corporate Identity Number : U40109PB2010SGC033814

O/o Sr.Xen, TLSC Division, PSTCL, SAS Nagar

Ph. 8360167986 E-mail : srxen-tlss-moh@pstcl.org

Memo No 2200

Dated 14-09-20

To

Senior Manager, Er. Sanjay Dhaked,  
Parbati Koldam Transmission Co. Ltd (PKTCL),  
(JV of PGCL and Indgrid Ltd)  
Vill. Chottigandhon, P.O. Rangeelpur,  
Ropar-140108

Subject:- LILO of one ckt. of existing 400kv D/C Ludhiana-Koldam at 400kv Substation Ropar.

PSTCL is constructing a new 400kv Substation Ropar, at GGSSTP, Ropar. LILO of one circuit of 400kv D/C (Triple Snowbird Conductor) line is to be done at proposed 400kv Substation Ropar is of Circuit No.-2 at Tower no. 161 of 400kv Ludhiana- Koldam D/e transmission line. Approval of PKTCL along with vetting of attached route plan is required for LILO of the said 400kv Line. Minutes of meeting of NRSC held at NRPC New Delhi are attached vide which approval for said LILO arrangement was given to PSTCL.

So, It is requested to accord the necessary approval at the earliest so that the LILO of Circuit No.2 of the said 400kv Line may get done at 400kv Substation Ropar. This is for your information and further action please.

D.A.:- As above.

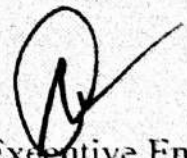
  
Sr. Executive Engineer  
TLSC Division, SAS Nagar.

Endst. No. 2201/03  
dt 14-09-2023

Dated:- 14.09.2023

(Through E-Mail)

Copy of the above is forwarded to the following for information and further action please:-

1. Dy Chief Engineer, TLSC Circle, PSTCL, Patiala.
2. Sr Xen/TS-1, PSTCL, Patiala w.r.t. your office letter no. 1306 dt. 01-09-2023
3. AEE, TLSC Subdivision, PSTCL, Mohali for follow up and pursue the case with concerned office

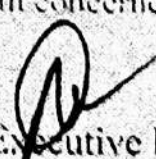
  
Senior Executive Engineer,  
TLSC Division, PSTCL, SAS Nagar.

# PARBATI KOLDAM TRANSMISSION COMPANY LIMITED

Corporate Office  
5<sup>th</sup> Floor, FF-1A, JMD Galleria, Sector - 48,  
Sohna Road, Gurugram - 122018, Phone: 9313622624  
Email: [complianceofficer@indgrid.co.in](mailto:complianceofficer@indgrid.co.in)

CIN: U40108MH2002PLC377967

Ref: **PKTCL/KL-RP/F.No-05/090**

Dated: December 16, 2023

To,  
Sr. Executive Engineer,  
TLSC Division, PSTCL,  
SAS Nagar, Punjab

Sub: LILO of one circuit of existing 400 kV D/C Koldam Ludhiana Transmission at 400 kV S/s at Ropar (Punjab)

Ref: 1. Your letter no-2817 dated 01.12.2023  
2. Our letter no- PKTCL/KL-RP/F. No-05/089 dated 21.11.2023

Sir,

In continuation of our earlier communication referred above on the cited subject, Please be informed that Central Electricity Authority (Measures relating to Safety and Electricity Supply) Regulation, 2023, Regulation 46(4) restricts tapping of transmission of voltage level 66 kV & above.

Citation of same is given below:

(4) There shall not be tapping of another transmission line from the main line for 66 kV and above class of lines:

Provided that during natural calamities, tapping may be allowed to ensure emergency power supply to affected areas till normalcy is restored.

In view of same, following is proposed in view of better reliability of the existing & proposed transmission system:

1. Loop-In should be done from Tower No-159 & Loop-Out should be done from Tower No-161 of existing 400 kV D/C Koldam Ludhiana Transmission line (CKT-II).
2. The span of either side of Tower No-1 (Proposed PSTCL tower) shall be more than 400 meters on either side hence an adequate body extension may please be used for maintaining ground clearance as per IS 5613.
3. If required, additional tower must be provided between existing Tower No-159/161 & Tower No-01 (proposed) for maintenance of adequate ground clearance and live metal clearances.

Hence your goodself is once again requested to submit the proposal for LILO of CKT-II of 400 kV Koldam Ludhiana Transmission Line after incorporating the proposed changes along with the profile of the relevant sections for necessary approval please.

Thanking You  
For Parbati Koldam Transmission Co. Ltd.

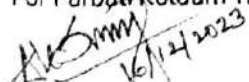
  
Amit Kumar Singh

Dy. General Manager

Copy To: 1. Dy Chief Engineer, TLSC Circle, PSTCL, Patiala, Punjab for information please.  
2. AEE, TLSC Subdivision, PSTCL, Mohali, Punjab for information please.

Registered Office: Unit No. 101, First Floor, Windsor, Village Kolekatyan, off CST Road,  
Vidyanagari Marg, Kalina, Santacruz (East) Mumbai - 400098, Maharashtra, India  
Ph: +91 72084 93885 | [www.Indgrid.co.in](http://www.Indgrid.co.in)

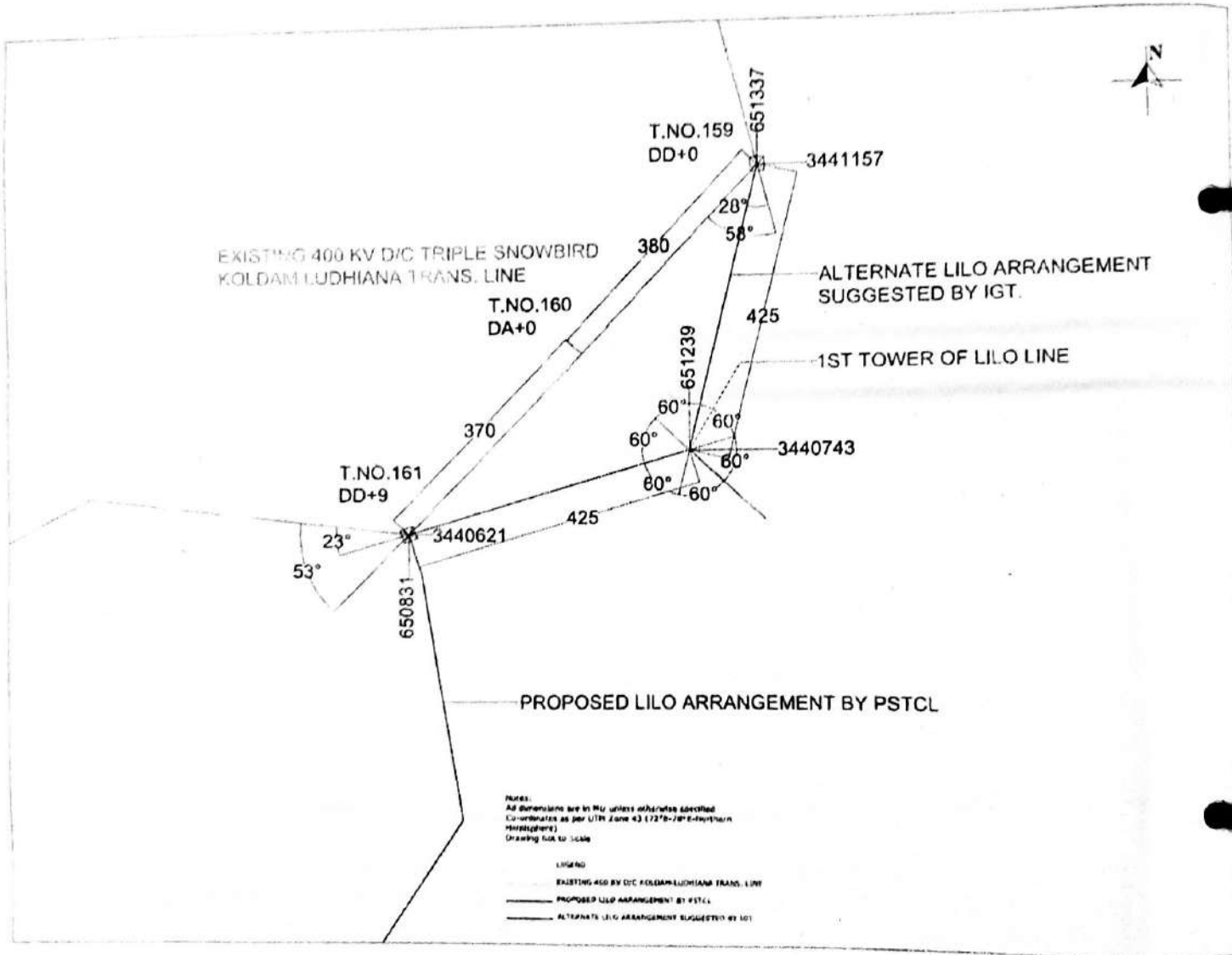

*Handwritten signature*

## CENTRAL ELECTRICITY AUTHORITY

## NOTIFICATION

New Delhi, the 8th June, 2023

**No. CEA-PS-16/1/2021-CEI Division.**—Whereas the draft of the Central Electricity Authority (Measures relating to Safety and Electric Supply) Regulations, 2022 was published in six newspaper dailies, as required by sub-section (3) of section 177 of the Electricity Act, 2003 (36 of 2003) read with sub-rule (2) of rule 3 of the Electricity (Procedure for Previous Publication) Rules, 2005 for inviting objections and suggestions from all persons likely to be affected thereby, before the expiry of the period of forty-five days, from the date on which the copies of the newspaper containing the said draft regulations were made available to the public;

And whereas copies of the said newspapers containing the public notices and the said draft regulations on the website of the Central Electricity Authority were made available to the public on 14<sup>th</sup> June, 2022;

And whereas the objections and suggestions received from the public on the said draft regulations were considered by the Central Electricity Authority;

Now, therefore, in exercise of the powers conferred by clause (b) of sub-section (2) of section 177 and read with section 53 of the Electricity Act, 2003, and in suppression of the Central Electricity Authority (Measures relating to Safety and Electric Supply) Regulations, 2010, except as respects things done or omitted to be done before such suppressions, the Central Electricity Authority hereby makes the following regulations, namely: —

## Chapter I

## Preliminary

**1. Short title and Commencement.** — (1) These regulations may be called the Central Electricity Authority (Measures relating to Safety and Electric Supply) Regulations, 2023.

(2) These regulations shall come into force on the date of publication in the Official Gazette.

(3) **Scope and extent of application.** — These regulations shall be applicable to electrical installation including electrical plant and electric line, and the person engaged in the generation or transmission or distribution or trading or supply or use of electricity.

**2. Definitions.** — (1) In these regulations, unless the context otherwise requires,

- (a) "Act" means the Electricity Act, 2003 (36 of 2003);
- (b) "accessible" means within physical reach without the use of any appliance or special effort;
- (c) "aerial bunched cable" means polyethylene or cross linked polyethylene insulated cable having three or four cores with aluminium conductors twisted over a central bare or insulated aluminium alloy or steel messenger wire;
- (d) "apparatus" means electrical apparatus and includes all machines, fittings, accessories and appliances in which conductors are used;
- (e) "bare" means not covered with insulating materials;
- (f) "bonding conductor" means the inter connecting conductors for the purpose of equipotential bonding with the main earth;
- (g) "cable" means a length of insulated single conductor, solid or stranded, or two or more such conductors each provided with its own insulation, which are laid up together;
- (h) "chartered electrical safety engineer" means a person authorised by the Appropriate Government as referred in regulation 6;
- (i) "circuit" means an arrangement of conductor or conductors for conveying electricity and forming a system or a branch of a system and protected at the origin;
- (j) "circuit breaker" means a mechanical switching device, capable of making, carrying and breaking currents under normal circuit conditions and also making, carrying for a specified duration and breaking currents under specified abnormal circuit condition;
- (k) "concentric cable" means a composite cable comprising an inner conductor which is insulated and one or more outer conductors which are insulated from one another and are disposed over the insulation of, and more or less around, the inner conductor;
- (l) "conductor" means any wire, cable, bar, tube, rail or plate used for conducting electricity;



exceeding 30 milliampere shall be used:

Provided further that such protective device shall not be required for supply lines having protective devices which are effectively bonded to the neutral of supply transformers and conforming to regulation 76.

#### Chapter VI

#### Safety provisions for electrical installations and apparatus of voltage exceeding 650 V

45. **Approval by the Electrical Inspector and self-certification.** – (1) (a) Every electrical installation of notified voltage and below shall be inspected, tested and self-certified by the owner or supplier or consumer, as the case may be, of the installation before commencement of supply or recommencement after shutdown for six months or more for ensuring observance of safety measures specified under these regulations and such owner or supplier or consumer, as the case may be, shall submit the report of self-certification to the Electrical Inspector in the forms as provided under Schedule II of these regulations:

Provided that the self-certified electrical installation shall be considered fit for the commencement of supply or recommencement after shutdown for six months only after the report of self-certification is duly received by the office of Electrical Inspector and if not acknowledged by the Electrical Inspector within three working days, it shall be deemed to be received:

Provided further that the owner or supplier or consumer, as the case may be, has the option to get his installation inspected and tested by the Electrical Inspector of the Appropriate Government;

(b) Notwithstanding anything contained in clause (a), every electrical installation covered under section 54 of the Act including every electrical installation of railways shall be inspected and tested by the Electrical Inspector of the Appropriate Government as specified in sub-regulation (3).

(2) The voltage above which inspection and testing of electrical installations including installations of supplier or consumer to be carried out by the Electrical Inspector, shall be notified by the Appropriate Government;

(3) Every electrical installation of voltage above the notified voltage and all the apparatus of the generating units above the capacity specified under regulation 34, shall be inspected and tested by the Electrical Inspector before commencement of supply or recommencement after shutdown for six months or more for ensuring observance of safety measures specified under these regulations.

(4) Before making an application to the Electrical Inspector for permission to commence or recommence supply in installations above the notified voltage after an installation has been disconnected for six months or more, the supplier shall ensure that electric supply lines or apparatus of more than notified voltage belonging to him are placed in position, properly joined, and duly completed and examined, and the supply of electricity shall not be commenced by the supplier for installations of voltage needing inspection under these regulations unless the provisions of regulations 14 to 31, regulations 35 to 37, regulations 46 to 53 and regulations 57 to 80 have been complied with and the approval in writing of the Electrical Inspector has been obtained by him:

Provided that the supplier may energise the aforesaid electric supply lines or apparatus for the purpose of tests specified in regulation 48.

(5) The owner of any installations of voltage above the notified voltage shall, before making application to the Electrical Inspector for approval of his installation or additions thereto, test every circuit or additions thereto, other than an overhead line, and satisfy himself that they withstand the application of the testing voltage set out in regulation 48 and shall duly record the results of such tests and submit them to the Electrical Inspector:

Provided that the Electrical Inspector may direct such owner to carry out such tests, as he deems necessary or accept the certified tests of the manufacturer in respect of any particular apparatus in place of the tests required by this regulation.

(6) The owner of any installation who makes any addition or alteration to his installation shall not connect to the supply his apparatus or electric supply lines, comprising the said alterations or additions, unless and until such alteration or addition has been approved in writing by the Electrical Inspector or self-certified by the owner of the installation, as the case may be.

(7) In case of installations of mines and oil-fields, the electrical installations of voltage 650 V and above shall not be connected to supply, unless and until such installation work including alterations or additions or recommencement after shutdown for six months are approved in writing by the Electrical Inspector of Mines:

Provided that the electrical installations of voltage below 650 V in mines and oil-fields are to be self-certified by the owner or agent or manager of the mine before commencement of supply or recommencement after shutdown for six months or more in the manner specified in sub-regulation (1).

46. **Use of electricity at voltage exceeding 650 V.** – (1) The Electrical Inspector where the supply voltage exceeds

the notified voltage shall not authorise the supplier to commence supply or recommence the supply, where the supply has been discontinued for a period of six months or more, or the supplier, where the supply voltage is equal to or below the notified voltage but exceeds 650 V, shall not commence supply or recommence the supply where supply has been discontinued for a period of six months or more, to any consumer unless, –

(a) all conductors and apparatus situated on the premises of the consumer are so placed as to be inaccessible except to the designated person;

(b) the consumer has provided and agreed to maintain a separate building or a locked weather proof and fire proof enclosure of agreed design and location, to which the supplier at all times shall have access for the purpose of housing his apparatus and metering equipment, or where the provision for a separate building or enclosure is impracticable, the consumer has segregated the aforesaid apparatus of the supplier from any other part of his own apparatus:

Provided that the segregation shall be made by the fire walls, if the Electrical Inspector considers it to be necessary:

Provided further that in the case of an outdoor installation the consumer shall suitably segregate the aforesaid apparatus belonging to the supplier from his own;

(c) all pole type substations are constructed and maintained in accordance with regulation 52.

(2) Where electricity at voltage exceeding 650 V is supplied, converted, transformed or used, the owner shall, –

(i) maintain safety clearances for electrical apparatus as per relevant standards specification so that sufficient space is available for easy operation and maintenance without any hazard to the operating and maintenance personnel working near the equipment and for ensuring adequate ventilation:

Provided that in case of mines, the safety clearances for electrical apparatus to be as per relevant mining regulations;

(ii) not allow any encroachment below such installation:

Provided that where the Electrical Inspector comes across any such encroachment, he shall direct the owner to remove such encroachments;

(iii) maintain minimum safety working clearances specified in Schedule V for the bare conductors or live parts of any apparatus in outdoor substations excluding overhead lines of installations of voltage exceeding 650 V;

(iv) ensure that the live parts of all apparatus within the reach from any position in which a person may require to be, are suitably protected to prevent danger;

(v) ensure that where the transformer is used, suitable provision shall be made, either by connecting with earth, a point of the circuit at the lower voltage or otherwise, to guard against danger by reason of the said circuit becoming accidentally charged above its normal voltage by leakage from or contact with the circuit at the higher voltage;

(vi) not install a substation or a switching station with apparatus having more than 2000 litre of oil in the basement where proper oil draining arrangement cannot be provided;

(vii) undertake the following measures, where a substation or a switching station with oil-filled apparatus, such as transformer, static condenser, switchgear or oil circuit breaker having more than 2000 litre of oil is installed, whether indoor or outdoors,-

(a) the separation wall or fire barrier walls of thickness and dimensions as specified in the relevant standards shall be provided between the apparatuses and between the apparatus and adjacent building if building wall adjacent to the apparatuses is not rated for four hours fire withstand rating;

(b) provisions shall be made for suitable oil soakpit and where use of more than 9000 litre of oil in any one oil tank, receptacle or chamber is involved, provision shall be made for the draining away or removal of any oil which may leak or escape from the tank, receptacle or chamber containing the same, and special precautions shall be taken to prevent the spread of any fire resulting from the ignition of the oil from any cause and adequate provision shall be made for extinguishing any fire which may occur;

(c) spare oil shall not be stored in the vicinity of any oil filled equipment in any such substation or switching station; and

(d) all the transformers and switchgears shall be maintained in accordance with the maintenance schedules prepared in accordance with the relevant standards;

- (viii) without prejudice to the above measures, undertake adequate fire detection and protection arrangement for quenching the fire of the apparatus;
- (ix) ensure that every transformer of 10 MVA or reactor of 10 MVAR and above rating shall be provided with automatic fire fighting system as per relevant standards;
- (x) undertake the following measures, where it is necessary to locate the substation, or switching station in the basement, namely: –
- (a) the transformer room be in the first basement at the periphery;
  - (b) the direct access to the transformer room be provided from outside and the surrounding walls of four hours fire withstand rating be provided as per relevant standards;
  - (c) the entrances to the transformer room be provided with fire resistant doors of two hour fire rating and the door shall always be kept closed and a notice of this effect be affixed on outer side of the door;
  - (d) a curb of a suitable height be provided at the entrance in order to prevent the flow of oil from a ruptured transformer into other parts of the basement;
  - (e) the cables to primary side and secondary side have sealing at all floors and wall opening of atleast two hours fire withstand rating; and
  - (f) Fire Retardant Low Smoke Low Halogen cable as per relevant standards be used;
- (xi) ensure that oil filled transformers installed indoors in other than residential or commercial buildings are placed on the ground floor or not below the first basement;
- (xii) ensure that only dry type transformer shall be used inside the residential and commercial buildings;
- (xiii) ensure that cable trenches inside the substations and switching stations containing cables are filled with sand, pebbles or similar non-inflammable materials or completely covered with non-inflammable slabs; and
- (xiv) ensure that unless the conditions are such that all the conductors and apparatus may be made dead at the same time for the purpose of cleaning or for other work, the said conductors and apparatus shall be so arranged that these may be made dead in sections, and that work on any such section may be carried on by the person designated or appointed or engaged or permitted under these regulations without danger.

(3) The minimum clearances specified in Schedule VI shall be maintained for bare conductors or live parts of any high voltage direct current apparatus in outdoor substations, excluding high voltage direct current overhead lines.

**(4) There shall not be tapping of another transmission line from the main line for 66 kV and above class of lines.**

Provided that during natural calamities, tapping may be allowed to ensure emergency power supply to affected areas till normalcy is restored.

**47. Inter-locks and protection for use of electricity at voltage exceeding 650 V.** – (1) The owner shall ensure the following, namely: –

- (i) isolators and the controlling circuit breakers shall be inter-locked so that the isolators cannot be operated unless the corresponding breaker is in open position;
- (ii) isolators and the corresponding earthing switches shall be inter-locked so that no earthing switch can be closed unless and until the corresponding isolator is in open position;
- (iii) where two or more supplies are not intended to be operated in parallel, the respective circuit breakers or linked switches controlling the supplies shall be inter-locked to prevent possibility of any inadvertent paralleling or backfeed;
- (iv) when two or more transformers are operated in parallel, the system shall be so arranged as to trip the secondary breaker of the transformer in case the primary breaker of that transformer trips;
- (v) all gates or doors which provide access to live parts of an installation shall be inter-locked in such a way that these cannot be opened unless the live parts are made dead and proper discharging and earthing of these parts shall be ensured before any person comes in close proximity of such parts; and
- (vi) where two or more generators operate in parallel and neutral switching is adopted, inter-lock shall be provided to ensure that the generator breaker cannot be closed unless one of the neutrals is connected to the earthing system.

**CENTRAL ELECTRICITY AUTHORITY  
NOTIFICATION**

**New Delhi, the 20th September, 2010**

No. CEI/1/59/CEA/EI.—In exercise of the powers conferred by section 177 of the Electricity Act, 2003 (36 of 2003); the Central Electricity Authority hereby makes the following regulations for Measures relating to Safety and Electric Supply, namely:-

**Chapter I**

**1. Short title and Commencement.-** (1) These regulations may be called the Central Electricity Authority (Measures relating to Safety and Electric Supply) Regulations, 2010.

(2) They shall come into force on the date of their final publication in the Official Gazette.

- 2. Definitions.-** (1) In these regulations, unless the context otherwise requires,
- (a) "Act" means the Electricity Act, 2003;
  - (b) "accessible" means within physical reach without the use of any appliance or special effort;
  - (c) "ampere" means a unit of electric current and is a constant current which, flowing in two parallel straight conductors of infinite length of negligible cross section and placed at a distance of one meter apart in a vacuum will produce a force of  $2 \times 10^{-7}$  Newton per meter length between the conductors;
  - (d) "apparatus" means electrical apparatus and includes all machines, fittings, accessories and appliances in which conductors are used;
  - (e) "bare" means not covered with insulating materials;
  - (f) "cable" means a length of insulated single conductor (solid or stranded) or of two or more such conductors each provided with its own insulation, which are laid up together. Such insulated conductor or conductors may or may not be provided with an overall mechanical protective covering;
  - (g) "circuit" means an arrangement of conductor or conductors for the purpose of conveying electricity and forming a system or a branch of a system;
  - (h) "circuit breaker" means a device, capable of making and breaking the circuit under all conditions, and unless otherwise specified, so designed as to break the current automatically under abnormal conditions;
  - (i) "concentric cable" means a composite cable comprising an inner conductor which is insulated and one or more outer conductors which are

## Chapter VI

### Safety provisions for electrical installations and apparatus of voltage exceeding 650 volts

43. **Approval by Electrical Inspector.** - (1) Voltage above which electrical installations will be required to be inspected by the Electrical Inspector before commencement of supply or recommencement after shutdown for six months and above shall be as per the notification to be issued by the Appropriate Government, under clause (x) of sub-section (2) of section 176 and sub-section (1) of section 162 of the Act.

(2) Before making an application to the Electrical Inspector for permission to commence or recommence supply after an installation has been disconnected for six months and above at voltage exceeding 650 V to any person, the supplier shall ensure that electric supply lines or apparatus of voltage exceeding 650 V belonging to him are placed in position, properly joined and duly completed and examined and the supply of electricity shall not be commenced by the supplier for installations of voltage needing inspection under these regulations unless the provisions of regulations 12 to 29, 33 to 35, 44 to 51 and 55 to 77 have been complied with and the approval in writing of the Electrical Inspector has been obtained by him:

Provided that the supplier may energise the aforesaid electric supply lines or apparatus for the purpose of tests specified in regulation 46.

(3) The owner of any installation of voltage exceeding 650 V shall, before making application to the Electrical Inspector for approval of his installation or additions thereto, test every circuit of voltage exceeding 650 V or additions thereto, other than an overhead line, and satisfy himself that they withstand the application of the testing voltage set out in sub-regulation (1) of regulation 46 and shall duly record the results of such tests and forward them to the Electrical Inspector:

Provided that an Electrical Inspector may direct such owner to carry out such tests as he deems necessary or accept the manufacturer's certified tests in respect of any particular apparatus in place of the tests required by this regulation

(4) The owner of any installation of voltage exceeding 650 V who makes any addition or alteration to his installation shall not connect to the supply his apparatus or electric supply lines, comprising the said alterations or additions unless and until such alteration or addition has been approved in writing by the Electrical Inspector.

44. **Use of electricity at voltage exceeding 650 Volts.** - (1) The Electrical Inspector shall not authorise the supplier to commence supply or where the supply has been discontinued for a period of six months and above, to recommence the supply at voltage exceeding 650 V to any consumer unless-

(i) all conductors and apparatus situated on the premises of the consumer are so placed as to be inaccessible except to a designated person

and all operations in connection with the said conductors and apparatus are carried out by a designated person;

(ii) the consumer has provided and agrees to maintain a separate building or a locked weather proof and fire proof enclosure of agreed design and location, to which the supplier at all times shall have access for the purpose of housing his apparatus and metering equipment, or where the provision for a separate building or enclosure is impracticable, the consumer has segregated the aforesaid apparatus of the supplier from any other part of his own apparatus:

Provided that such segregation shall be by the provision of fire proof walls, if the Electrical Inspector considers it to be necessary:

Provided further that in the case of an outdoor installation the consumer shall suitably segregate the aforesaid apparatus belonging to the supplier from his own;

(iii) all pole type sub-stations are constructed and maintained in accordance with regulation 50.

(2) The owner shall observe the following conditions, where electricity at voltage exceeding 650 V is supplied, converted, transformed or used,-

(i) he shall maintain safety clearances for electrical apparatus as per Bureau of Indian Standard specification so that sufficient space is available for easy operation and maintenance without any hazard to the operating and maintenance personnel working near the equipment and for ensuring adequate ventilation;

(ii) he shall not allow any encroachment below such installation:

Provided that where the Electrical Inspector comes across any such encroachment, he shall direct the owner to remove such encroachments;

(iii) the minimum safety working clearances specified in Schedule-VII shall be maintained for the bare conductors or live parts of any apparatus in outdoor sub-stations excluding overhead lines of installations of voltage exceeding 650 V;

(iv) he shall ensure that the windings of motors or other apparatus within reach from any position in which a person may require to be, are suitably protected so as to prevent danger;

(v) he shall ensure that where a transformer or transformers are used, suitable provision shall be made, either by connecting with earth, a point of the circuit at the lower voltage or otherwise, to guard against danger by reason of the said circuit becoming accidentally charged above its normal voltage by leakage from or contact with the circuit at the higher voltage;

(vi) a sub-station or a switching station with apparatus having more than 2000 litres of oil shall not be located in the basement where proper oil draining arrangement cannot be provided;

(vii) where a sub-station or a switching station with apparatus having more than 2000 litres of oil is installed, whether indoor or outdoors, he shall take the following measures, namely:-

(a) the baffle walls of four hours fire rating shall be provided between the apparatus,-

(i) where there is a single phase transformer banks in the switch-yards of generating stations and sub-stations;

(ii) on the consumer premises;

(iii) where adequate clearance between the units is not available.

(b) provisions shall be made for suitable oil soakpit and where use of more than 9000 litres of oil in any one oil tank, receptacle or chamber is involved, provision shall be made for the draining away or removal of any oil which may leak or escape from the tank, receptacle or chamber containing the same, and special precautions shall be taken to prevent the spread of any fire resulting from the ignition of the oil from any cause and adequate provision shall be made for extinguishing any fire which may occur;

(c) spare oil shall not be stored in the vicinity of any oil filled equipment in any such sub-station or switching station;

(d) all the transformers and switchgears shall be maintained in accordance with the maintenance schedules prepared in accordance with the relevant codes of practice of Bureau of Indian Standards;

(e) dry type of transformers only shall be used for installations inside the residential and commercial buildings;

(viii) without prejudice to the above measures, he shall take adequate fire protection arrangement for quenching the fire in the apparatus;

(ix) he shall ensure that the transformers of 10 MVA and above rating or in case of oil filled transformers with oil capacity of more than 2000 liters are provided with fire fighting system as per IS - 3034: 1993 or with Nitrogen Injection Fire Protection system;

(x) where it is necessary to locate the sub-station, or switching station in the basement, he shall take the following measures, namely:-

- (a) the room shall necessarily be in the first basement at the periphery of the basement;
- (b) the entrances to the room shall be provided with fire resisting doors of 2 hour fire rating and the door shall always be kept closed and a notice of this effect shall be affixed on outer side of the door;
- (c) a curb (sill) of a suitable height shall be provided at the entrance in order to prevent the flow of oil from a ruptured transformer into other parts of the basement;
- (d) direct access to the transformer room shall be provided from outside and the surrounding walls shall be lined with fire bricks;
- (e) the cables to primary side and secondary side shall have sealing at all floors and wall opening of atleast two hours rating;
- (f) fire Retardent Low Smoke (FRLS) cable of two hours rating shall be used.
- (xi) he shall ensure that oil filled transformers installed indoors in other than residential or commercial buildings are placed at the ground floor or not below the first basement;
- (xii) he shall ensure that cable trenches inside the sub-stations and switching stations containing cables are filled with sand, pebbles or similar non-inflammable materials or completely covered with non-inflammable slabs;
- (xiii) he shall ensure that unless the conditions are such that all the conductors and apparatus may be made dead at the same time for the purpose of cleaning or for other work, the said conductors and apparatus shall be so arranged that these may be made dead in sections, and that work on any such section may be carried on by a designated person without danger;
- (xiv) only persons designated under sub-regulation (1) of regulation 3, shall carry out the work on live lines and apparatus.
- (3) All apparatus shall be protected against lightning and apparatus exceeding 220 kV shall also be protected against switching over voltages.
- (4) The equipment used for protection and switching shall be adequately co-ordinated with the protected apparatus to ensure safe operation and to maintain the stability of the inter-connected units of the power system.
- (5) The minimum clearances specified in Schedule-VIII shall be maintained for bare conductors or live parts of any apparatus in outdoor sub-stations, excluding overhead lines of High Voltage Direct Current installations.



(6) There shall not be tapping of another transmission line, from the main line for 56 kV and above class of lines.

45. Inter-locks and protection for use of electricity at voltage exceeding 650 Volts.- (1) The owner shall ensure the following, namely:-

(i) isolators and the controlling circuit breakers shall be inter-locked so that the isolators cannot be operated unless the corresponding breaker is in open position;

(ii) isolators and the corresponding earthing switches shall be inter-locked so that no earthing switch can be closed unless and until the corresponding isolator is in open position;

(iii) where two or more supplies are not intended to be operated in parallel, the respective circuit breakers or linked switches controlling the supplies shall be inter-locked to prevent possibility of any inadvertent paralleling or feedback;

(iv) when two or more transformers are operated in parallel, the system shall be so arranged as to trip the secondary breaker of a transformer in case the primary breaker of that transformer trips;

(v) all gates or doors which give access to live parts of an installation shall be inter-locked in such a way that these cannot be opened unless the live parts are made dead and proper discharging and earthing of these parts should be ensured before any person comes in close proximity of such parts;

(vi) where two or more generators operate in parallel and neutral switching is adopted, inter-lock shall be provided to ensure that generator breaker cannot be closed unless one of the neutrals is connected to the earthing system.

(2) The following protection shall be provided in all systems and circuits to automatically disconnect the supply under abnormal conditions, namely:-

(i) over current protection to disconnect the supply automatically if the rated current of the equipment, cable or supply line is exceeded for a time which the equipment, cable or supply line is not designed to withstand;

(ii) earth fault or earth leakage protection to disconnect the supply automatically if the earth fault current exceeds the limit of current for keeping the contact potential within the reasonable values;

(iii) gas pressure type and winding and oil temperature protection to give alarm and tripping shall be provided on all transformers of ratings 1000 KVA and above;

(iv) transformers of capacity 10 MVA and above shall be protected against incipient faults by differential protection;



**पावरग्रिड**  
**POWERGRID**

पावर ग्रिड कॉर्पोरेशन ऑफ इंडिया लिमिटेड  
(भारत सरकार का उद्यम)  
**POWER GRID CORPORATION OF INDIA LIMITED**  
(A Government of India Enterprise)

Ref. No. N2MLK/TL/PSTCL/2021/ 95

Date: 25.10.2021

To,

Addl. Superintending Engineer  
TLSC Division, PSTCL  
SAS Nagar

Subject: LILO of one circuit of 400KV D/C line from 400KV Jalandhar- Kurukshetra line at proposed 400KV S/s Dhanansu with 0.5sq" ACSR (Quad Moose) conductor (Tower Design PGCIL) reg.

Dear Sir,

In ref. to your Memo No. 1536 dt 22.09.2021, vide which you had submitted the proposal for LILO of one circuit of 400KV D/C (Quad) Kurukshetra- Jalandhar line (KJTL) from T.No. 436 (DD+0) at PSTCL Dhanansu s/s.

It is hereby informed you that the competent authority has accord technical approval for Tapping arrangement at tapping tower for proposed LILO of one ckt of 400KV D/C Kurukshetra- Jalandhar TL at PSTCL Dhanansu s/s. The approval of tapping tower is as under:

- (i) Tapping Tower: T.No. 436 (DD+0)
- (ii) Tapping Arrangement: Through T-Connectors
- (iii) Type of Conductor: ACSR Moose Conductor.
- (iv) The rest parameters shall be as per plan submitted by PSTCL.

PSTCL shall intimate POWERGRID for requirement of shutdown atleast 01 month prior before execution at site and PSTCL shall arrange Joint Verification for tapping arrangement at site during the execution of work. Further, the work should be done with high standards of workmanship.

Thanking you,

Yours Faithfully,

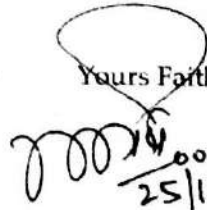
  
25/10/21

मनीष कुमार / MANISH KUMAR  
मुख्य प्रबन्धक (पा.ए) / Chief Manager (TL)  
400/220 के.वी.उपकेंद्र/400/220 KV S/Stn.  
पावरग्रिड मलेरकोटला/ POWERGRID Malerkotla

400/220 के.वी. उप-केंद्र, लुधियाना रोड, मलेरकोटला-148023, दूरभाष : (फा.) 01675-263554, ई-मेल : pgmalerkotla@powergrid.co.in

400/220 KV Substation, Ludhiana Road, Malerkotla-148023, Ph: (O)01675-263554, E-mail : pgmalerkotla@powergrid.co.in

क्षेत्रीय मुख्यालय : ग्रिड भवन, नजदीक बहू प्लाजा, रेल हेड कॉम्प्लेक्स, जम्मू-180012, दूरभाष 0191-2471194, 2471485

Regional Head Quarter: Grid Bhawan, Near Bahu Plaza, Rail Head Complex, Jammu-180012, Tel: 0191-2471194, 2471485

केन्द्रीय कार्यालय : "सौदामिनी", प्लॉट नं. 2, सेक्टर-29, गुरुग्राम-122001, (हरियाणा), दूरभाष 0124-2571700-719

Corporate Office : "Saudamini", Plot No. 2, Sector-29, Gurugram-122001, (Haryana) Tel : 0124-2571700-719

पंजीकृत कार्यालय : सी-9, कतुब इस्टीट्यूशनल एरिया, कटवासा सराय, नई दिल्ली - 110 016 दूरभाष : 011-26560112, 26560121, 26564812, 26564892, सीआईएन : L40101DL1989GOI038121

Registered Office : B-9, Outab Institutional Area, Katwana Sarai, New Delhi-110 016. Tel. 011-26560112, 26560121, 26564812, 26564892, CIN : L40101DL1989GOI038121

Website : www.powergridindia.com



# उत्तराखण्ड पावर कारपोरेशन लि०

Annexure-XX

(उत्तराखण्ड सरकार का उपक्रम)

## Uttarakhand Power Corporation Ltd.

(A. Govt. of Uttarakhand Undertaking)

CIN : U40109UR2001SGC025867

Email ID: md@upcl.org, Website: www.upcl.org

No.: 548 / MD/UPCL/ M-1

Dated: 29.01.2024

Member Secretary (NRPC)  
Northern Regional Power Committee  
A-18, Shaheed Jeet Singh Marg, Katwaria Sarai  
New Delhi - 110016.

**Sub: Regarding 71<sup>st</sup> NRPC Meeting on 29.01.2024 observations regarding "Installation of Reactive Power Solution on 33/11 kV substations in Uttarakhand".**

Respected Sir,

Kindly refer the proposal submitted to NRPC regarding DPR of "Installation of Reactive Power Solution on 33/11 kV substations in Uttarakhand".

In this regard the proposal was discussed in 71<sup>st</sup> NRPC meeting on 29 January, 2024. Following are the clarifications of your kind observations as directed:

1. The proposal has been discussed with STU (PTCUL). The appraisal of this project by STU is being attached with this letter (Attach 1). Technical observation of STU is "The system will enable to maintain proper voltage profile automatically at the respective 33 kV substation thereby reducing reactive power losses to the minimum. This will also avoid line losses arising out of extra reactive power flow in the transmission network and provide more stability/strength to the Grid". Further STU has recommended that "this project would be beneficial for both Transmission Utility (PTCUL) and Distribution Company (UPCL) and to the National Grid in larger interest". This is also to state that PTCUL has no proposal for installation of Reactive Power Solution with PSDF presently.
2. As part of technical evaluation, RFMS and IPDS Modem data of feeders was shared with NRLDC. It was observed that some data were outliers. It was replied by UPCL that these outliers are because of technical issue regarding Modem communication and CT/PT wirings etc. it was further queried that these outliers had been taken care of. This is to state that field data have been verified with field officers and certificates were collected of all voltage and power factor data including the outlier data. This is being attached with this letter for your kind perusal (Attach 2).

Kindly consider the proposal of UPCL.

Encl: As above

(Shishir Shrivastava)  
Superintending Engineer (A) &  
Nodal Officer, PSDF  
No. /MD/UPCL

Copy forwarded to the following for information and necessary action:

1. Staff Officer-1 to Managing Director, UPCL, V.C.V. Gabar Singh Urja Bhawan, Dehradun.
2. Director (Project), UPCL, V.C.V. Gabar Singh Urja Bhawan, Dehradun.

(Shishir Shrivastava)  
Superintending Engineer (A) &  
Nodal Officer, PSDF